

This Owner's Manual is provided and hosted by [Appliance Factory Parts](#).

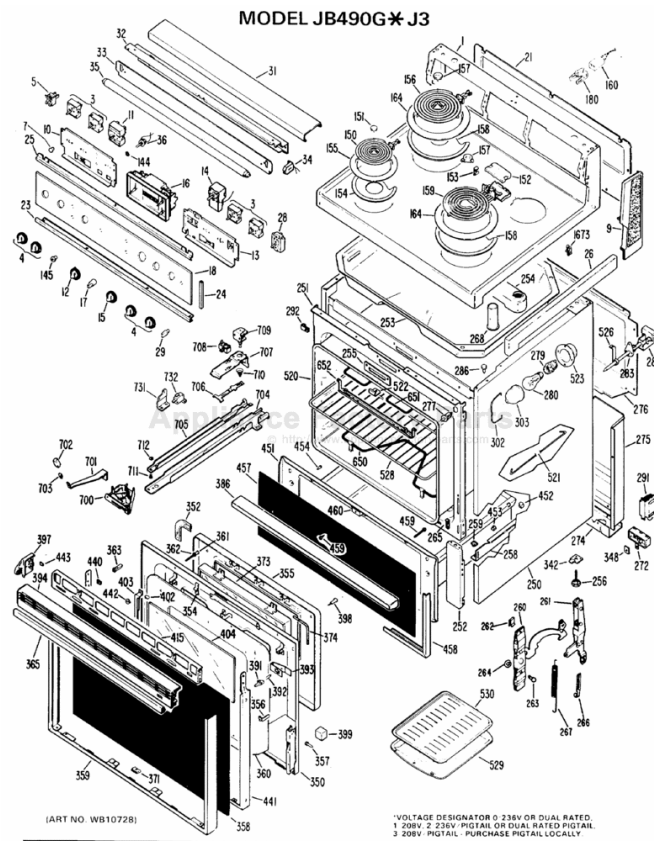

# GE JB490G\*J3 Owner's Manual

[Shop genuine replacement parts for GE JB490G\\*J3](#)



[Find Your GE Electric Range Parts - Select From 348 Models](#)

----- Manual continues below -----



1

## Range

### Contents

Aluminum Foil	16, 18	Vent Duct	22
Anti-Tip Bracket	3, 5	Problem Solver	26
Appliance Registration	2	Repair Service	27
Canning Tips	9	Safety Instructions	3, 4
Care and Cleaning	22-25	Surface Cooking	8
Clock/Timer	12	Control Settings	8
Energy-Saving Tips	5	Cookware Tips	10, 11
Features	6, 7	Light Bulb Replacement	23
Installation Instructions	5	Surface Units	23
Leveling	5	3-in-1 Surface Unit	8
Model and Serial Numbers	2	Warranty	Back Cover
Oven	13		
Baking, Baking Guide	14, 15		
Broiling, Broiling Guide	18, 19		
Control Settings	13		
Door Removal	22		
Light; Bulb Replacement	13, 22		
Preheating	13, 15		
Roasting, Roasting Guide	16, 17		
Self-Cleaning Instructions	20, 21		
Shelves	13	<b>GE Answer Center®</b>	
Thermostat Adjustment	24	<b>800.626.2000</b>	

Models JB391GK JSP27J  
 JB400GK JSP28GJ  
 JB490GJ

JB391GK  
 JB400GK  
 JB490GJ  
 JSP27J  
 JSP28G  
 JSP28GH  
 JSP28GJ

*GE Appliances*

EFFDATE 10-13-88

PUB  
49-4943

## Help us help you...

### **Before using your range, read this book carefully.**

It is intended to help you operate and maintain your new range properly.

Keep it handy for answers to your questions.

If you don't understand something or need more help, write (include your phone number):

Consumer Affairs  
GE Appliances  
Appliance Park  
Louisville, KY 40225

### **Write down the model and serial numbers.**

You'll find them on a label on the front of the range behind the oven door.

These numbers are also on the Consumer Product Ownership Registration Card that came with your range. Before sending in this card, please write these numbers here:

---

Model Number

---

Serial Number

Use these numbers in any correspondence or service calls concerning your range.

### **If you received a damaged range...**

Immediately contact the dealer (or builder) that sold you the range.

### **Save time and money. Before you request service...**

Check the Problem Solver on page 26. It lists causes of minor operating problems that you can correct yourself.

# IMPORTANT SAFETY INSTRUCTIONS

Read all instructions before using this appliance.

When using electrical appliances, basic safety precautions should be followed, including the following:

- Use this appliance only for its intended use as described in this manual.
- Be sure your appliance is properly installed and grounded by a qualified technician in accordance with the provided installation instructions.
- Don't attempt to repair or replace any part of your range unless it is specifically recommended in this book. All other servicing should be referred to a qualified technician.
- Before performing any service, **DISCONNECT THE RANGE POWER SUPPLY AT THE HOUSEHOLD DISTRIBUTION PANEL BY REMOVING THE FUSE OR SWITCHING OFF THE CIRCUIT BREAKER.**

## WARNING—All ranges

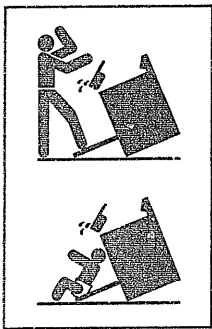

can tip and injury could result. To prevent accidental tipping of the range, attach it to the wall or floor by installing the

ANTI-TIP bracket supplied. To check if the bracket is installed and engaged properly, remove the drawer and inspect the rear leveling leg. Make sure it fits securely into the slot in the bracket.

If you pull the range out from the wall for any reason, make sure the rear leg is returned to its position in the bracket when you push the range back.

- Do not leave children alone—children should not be left alone or unattended in an area where an appliance is in use. They should never be allowed to sit or stand on any part of the appliance.

- Don't allow anyone to climb, stand or hang on the door, drawer or range top. They could damage the range and even tip it over, causing severe personal injury.

- **CAUTION: ITEMS OF INTEREST TO CHILDREN SHOULD NOT BE STORED IN CABINETS ABOVE A RANGE OR ON THE BACKSPASH OF A RANGE—CHILDREN CLIMBING ON THE RANGE TO REACH ITEMS COULD BE SERIOUSLY INJURED.**

- Never wear loose-fitting or hanging garments while using the appliance. Flammable material could be ignited if brought in contact with hot heating elements and may cause severe burns.

- Use only dry pot holders—moist or damp pot holders on hot surfaces may result in burns from steam. Do not let pot holders touch hot heating elements. Do not use a towel or other bulky cloth.

- Never use your appliance for warming or heating the room.

- Storage in or on appliance—Flammable materials should not be stored in an oven or near surface units.

- Keep hood and grease filters clean to maintain good venting and to avoid grease fires.

- Do not let cooking grease or other flammable materials accumulate in or near the range.

- Do not use water on grease fires. Never pick up a flaming pan. Smother flaming pan on surface unit by covering pan completely with well-fitting lid, cookie sheet or flat tray. Flaming grease outside a pan can be put out by covering with baking soda or, if available, a multi-purpose dry chemical or foam type fire extinguisher.

- Do not touch heating elements or interior surface of oven. These surfaces may be hot enough to burn even though they are dark in color. During and after use, do not touch, or let clothing or other flammable materials contact surface units, areas nearby surface units or any interior area of the oven; allow sufficient time for cooling, first.

Potentially hot surfaces include the cooktop and areas facing the cooktop, oven vent opening and surfaces near the opening, and crevices around the oven door. Remember: The inside surface of the oven may be hot when the door is opened.

- When cooking pork, follow the directions exactly and always cook the meat to an internal temperature of at least 170°F. This assures that, in the remote possibility that trichina may be present in the meat, it will be killed and the meat will be safe to eat.

(continued next page)

# IMPORTANT SAFETY INSTRUCTIONS (continued)

## Oven

- Stand away from range when opening oven door. Hot air or steam which escapes can cause burns to hands, face and/or eyes.
- Don't heat unopened food containers in the oven. Pressure could build up and the container could burst, causing an injury.
- Keep oven vent duct unobstructed.
- Keep oven free from grease buildup.
- Place oven shelf in desired position while oven is cool. If shelves must be handled when hot, do not let pot holder contact heating units in the oven.
- Pulling out shelf to the shelf stop is a convenience in lifting heavy foods. It is also a precaution against burns from touching hot surfaces of the door or oven walls.
- When using cooking or roasting bags in oven, follow the manufacturer's directions.
- Do not use your oven to dry newspapers. If overheated, they can catch fire.

## Self-Cleaning Oven

- Do not clean door gasket. The door gasket is essential for a good seal. Care should be taken not to rub, damage or move the gasket.
- Do not use oven cleaners. No commercial oven cleaner or oven liner protective coating of any kind should be used in or around any part of the oven.
- Clean only parts listed in this Use and Care Book.
- Before self-cleaning the oven, remove broiler pan and other accessories.

## Surface Cooking Units

- Use proper pan size—This appliance is equipped with one or more surface units of different size. Select utensils having flat bottoms large enough to cover the surface unit heating element. The use of undersized utensils will expose a portion of the heating element to direct contact and may result in ignition of clothing. Proper relationship of utensil to burner will also improve efficiency.
- Never leave surface units unattended at high heat settings. Boilover causes smoking and greasy spillovers that may catch on fire.
- Be sure drip pans and vent ducts are not covered and are in place. Their absence during cooking could damage range parts and wiring.
- Don't use aluminum foil to line drip pans or anywhere in the oven except as described in this book. Misuse could result in a shock, fire hazard or damage to the range.
- Only certain types of glass, glass/ceramic, earthenware or other glazed containers are suitable for range-top service; others may break because of the sudden change in temperature. (See section on "Surface Cooking" for suggestions.)
- To minimize burns, ignition of flammable materials, and spillage, the handle of a container should be turned toward the center of the range without extending over nearby surface units.
- Always turn surface unit to OFF before removing utensil.

- Keep an eye on foods being fried at HIGH or MEDIUM HIGH heats.
- To avoid the possibility of a burn or electric shock, always be certain that the controls for all surface units are at OFF position and all coils are cool before attempting to remove the unit.
- Don't immerse or soak removable surface units. Don't put them in a dishwasher. Do not self-clean the surface units in the oven.
- When flaming foods under the hood, turn the fan off. The fan, if operating, may spread the flame.
- Foods for frying should be as dry as possible. Frost on frozen foods or moisture on fresh foods can cause hot fat to bubble up and over sides of pan.
- Use little fat for effective shallow or deep-fat frying. Filling the pan too full of fat can cause spillovers when food is added.
- If a combination of oils or fats will be used in frying, stir together before heating, or as fats melt slowly.
- Always heat fat slowly, and watch as it heats.
- Use deep fat thermometer whenever possible to prevent overheating fat beyond the smoking point.

**SAVE THESE  
INSTRUCTIONS**

## Installing Your Range

Your range, like many other household items, is heavy and can settle into soft floor coverings such as cushioned vinyl or carpeting. When moving the range on this type of flooring, use care, and it is recommended that these simple and inexpensive instructions be followed.

The range should be installed on a sheet of plywood (or similar material) as follows: *When the floor covering ends at the front of the range*, the area that the range will rest on should be built up with plywood to the same level or higher than the floor covering. This will allow the range to be moved for cleaning or servicing.

## Leveling the Range

Leveling screws are located on each corner of the base of the range. Remove the bottom drawer and you can level the range on an uneven floor with the use of a nutdriver.

To remove drawer, pull drawer out all the way, tilt up the front and take it out. To replace drawer, insert glides at back of drawer beyond stop on range glides. Lift drawer if necessary to insert easily. Let front of drawer down, then push in to close.

One of the rear leveling screws will engage the ANTI-TIP bracket (allow for some side to side adjustment). Allow a minimum clearance of 1/8" between the range and the leveling screw that is to be installed into the ANTI-TIP bracket.

## Energy-Saving Tips

### Surface Cooking

- Use cooking utensils of medium weight aluminum, with tight-fitting covers, and flat bottoms which completely cover the heated portion of the surface unit.
- Cook fresh vegetables with a minimum amount of water in a covered pan.
- Watch foods when bringing them quickly to cooking temperatures at HIGH heat. When food reaches cooking temperature, reduce heat immediately to lowest setting that will keep it cooking.
- Use residual heat with surface cooking whenever possible. For example, when cooking eggs in the shell, bring water and eggs to boil, then turn to OFF position and cover with lid to complete the cooking.
- Use correct heat for cooking task:  
HIGH—to start cooking (if time allows, do not use HIGH heat to start).  
MEDIUM HIGH—quick browning.  
MEDIUM—slow frying.  
LOW—finish cooking most quantities, simmer—double boiler heat, finish cooking, and special for small quantities.  
WARM—to maintain serving temperature of most foods.
- When boiling water for tea or coffee, heat only the amount needed. It is not economical to boil a container full of water for one or two cups.

### Oven Cooking

- Preheat oven only when necessary. Most foods will cook satisfactorily without preheating. If you find that preheating is necessary, watch the indicator light, and put food in oven promptly after the light goes out.
- Always turn oven OFF before removing food.
- During baking, avoid frequent door openings. Keep door open as short a time as possible if it is opened.
- Be sure to wipe up excess spillage before starting the self-cleaning operation.
- Cook complete oven meals instead of just one food item. Potatoes, other vegetables, and some desserts will cook together with a main-dish casserole, meat loaf, chicken or roast. Choose foods that cook at the same temperature and in approximately the same time.
- Use residual heat in the oven whenever possible to finish cooking casseroles, oven meals, etc. Also add rolls or precooked desserts to warm oven, using residual heat to warm them.

# Features of Your Range

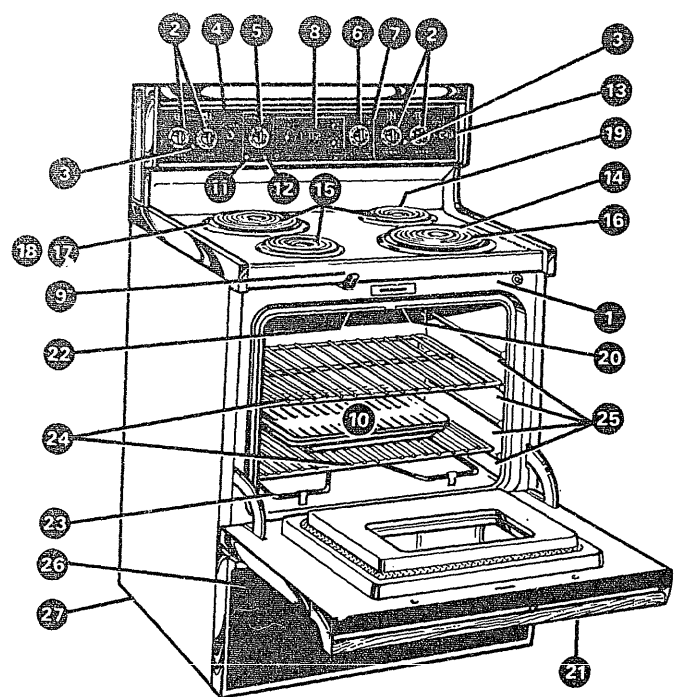

**Model JB490GJ**

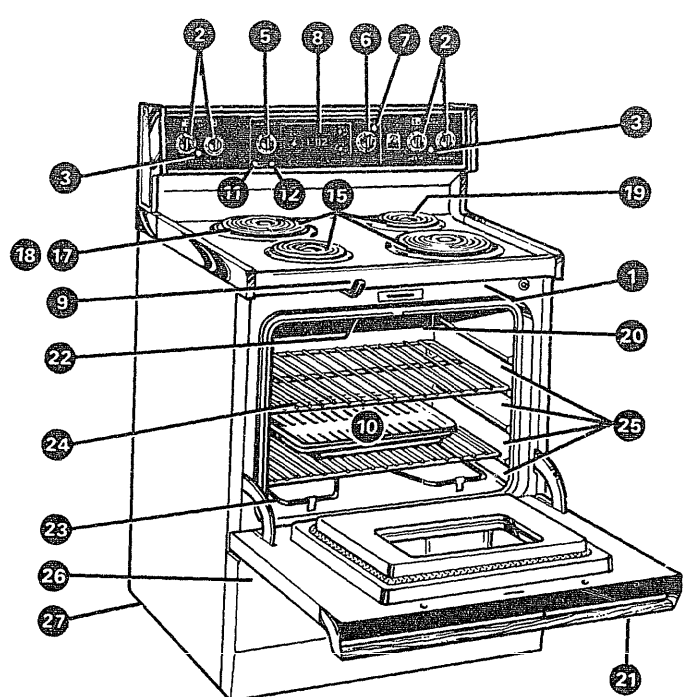

**Model JB400GK  
Model JB391GK**

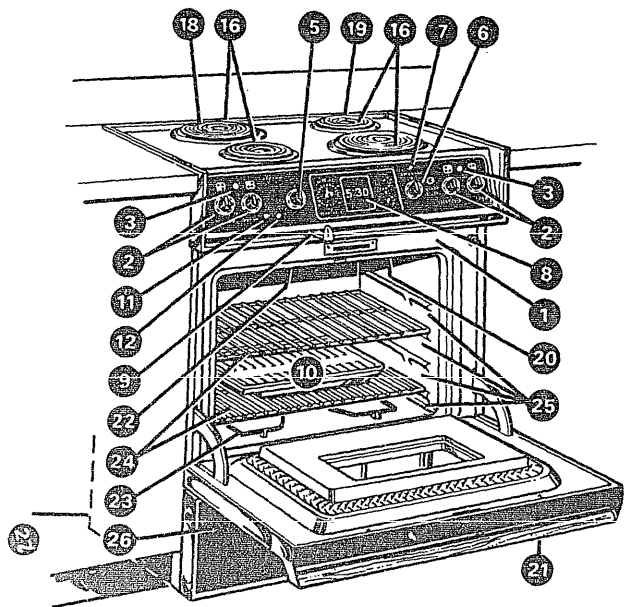

**Model JSP28GJ**

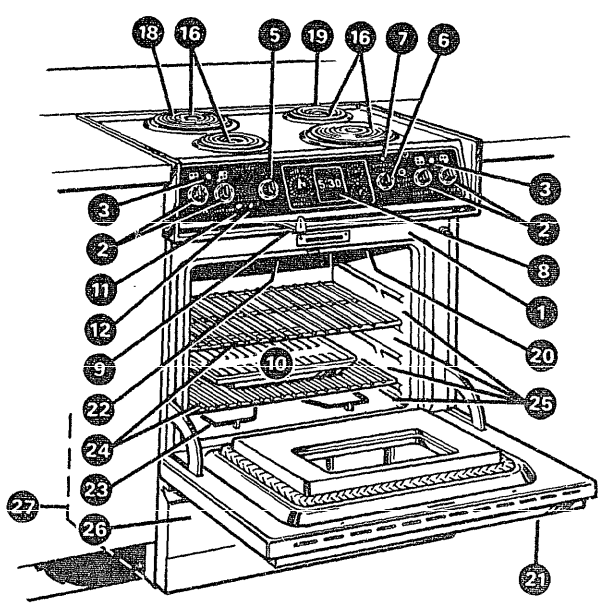

**Model JSP27J**

Feature Index	See Page	Model JB490GJ	Model JB400GK	Model JB391GK	Model JSP27J	Model JSP28GJ
1 Model and Serial Numbers	2	•	•	•	•	•
2 Surface Unit Controls	8	•	•	•	•	•
3 Surface Unit "On" Indicator Light	8	2	2	2	2	2
4 Cooktop Lamp Switch	13	•				
5 Oven Set Control	13	•	•	•	•	•
6 Oven Temp Control	13	•	•	•	•	•
7 Oven Cycling Light	13	•	•	•	•	•
8 Automatic Oven Timer, Clock and Minute Timer	12	•	•	•	•	•
9 Door Latch	20	•	•	•	•	•
10 Broiler Pan and Rack (Do not clean in Self-Clean oven.)	18	•	•	•	•	•
11 Door Locked Light	20	•	•	•	•	•
12 Oven Cleaning Light	20	•	•	•	•	•
13 3-in-1 Surface Unit Control	8	•				
14 3-in-1 Surface Unit	8	•				
15 Plug-In Surface Unit (May be removed when cleaning.)	23	2 6-in. 1 8-in.	2 6-in. 2 8-in.	2 6-in. 2 8-in.		
16 Tilt-Lock Surface Unit (May be raised but not removed.)	23	1 8-in.			2 6-in. 2 8-in.	2 6-in. 2 8-in.
17 Chrome-Plated Trim Rings and Porcelain Drip Pans	23		4			
18 Chrome-Plated Trim Rings and Aluminum Drip Pans	23	4		4	4	4
19 Oven Vent Duct (Under right rear surface unit.)	22	•	•	•	•	•
20 Oven Interior Light	22	•	•	•	•	•
21 Oven Light Switch	13	•	•	•	•	•
22 Broil Unit	18	•	•	•	•	•
23 Bake Unit	14	•	•	•	•	•
24 Oven Shelves	13	2	2	2	2	2
25 Oven Shelf Supports (Letters A, B, C and D indicate cooking position for shelves as suggested on cooking guides.)	13	•	•	•	•	•
26 Storage Drawer	22	•	•	•	•	•
27 Anti-Tip Bracket (See Installation Instructions)	3, 5	•	•	•	•	•

"G" in model number indicates Black Glass Door.



# Surface Cooking

See Surface Cooking Guide on pages 10-11.

## Surface Cooking with Infinite Heat Controls

Your surface units and controls are designed to give you an infinite choice of heat settings for surface unit cooking.

At both OFF and HI positions, there is a slight niche so control "clicks" at those positions; "click" on HI marks the highest setting; the lowest setting is between the words WM and OFF. In a quiet kitchen you may hear slight "clicking" sounds during cooking, indicating heat settings selected are being maintained.

Switching heats to higher settings always show a quicker change than switching to lower settings.

## How to Set the Controls

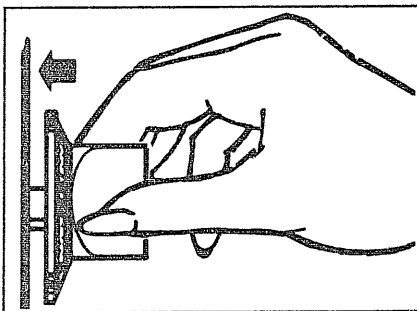

### Step 1

Grasp control knob and push in...

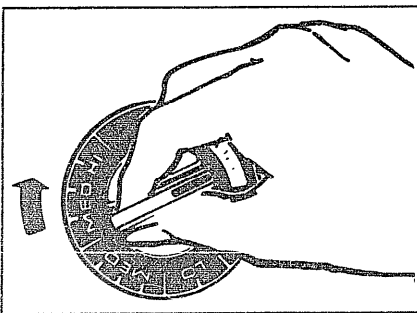

### Step 2

Turn either clockwise or counter-clockwise to desired heat setting.

Control must be pushed in to set only from OFF position. When control is in any position other than OFF, it may be rotated without pushing in.

Be sure you turn control to OFF when you finish cooking. An indicator light will glow when ANY heat on any surface unit is on.

## Cooking Guide for Using Heats

- HI** Quick start for cooking; bring water to boil.
- MED HI** Fast fry, pan broil; maintain fast boil on large amount of food.
- MED** Saute and brown; maintain slow boil on large amount of food.
- LO** Cook after starting at HI; cook with little water in covered pan.
- WM** Steam rice, cereal; maintain serving temperature of most foods.

### NOTE:

1. At HI, MED HI, never leave food unattended. Boilovers cause smoking; greasy spillovers may catch fire.
2. At WM, LO, melt chocolate, butter on small unit.

## How to Use the 3-in-1 Unit (Model JB490)

This surface unit offers the convenience of three units in one. The unit may be used as an 8-inch, 6-inch, or 4-inch unit to accommodate any size utensil. Turn size selector switch, next to surface unit control, to 8", 6" or 4". Then turn surface unit control to desired heat setting.

Match unit size selection to size of utensil.

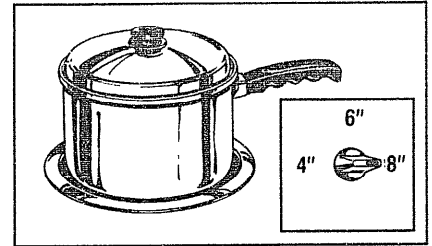

**LARGE**—8-inch unit. Turn switch to 8" when using large utensils that completely cover the unit (3-quart to 6-quart saucepans or 8- to 10-inch skillet). Then select desired heat setting.

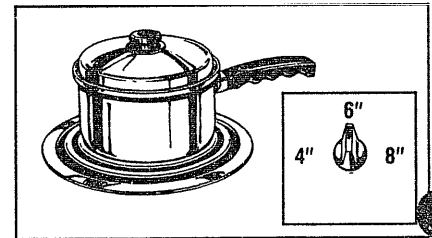

**MEDIUM**—6-inch unit. Turn switch to 6" when using medium-sized cooking utensils that do not completely cover the unit (2- to 2½-quart saucepans or 6- to 7-inch skillet). Then select desired heat setting.

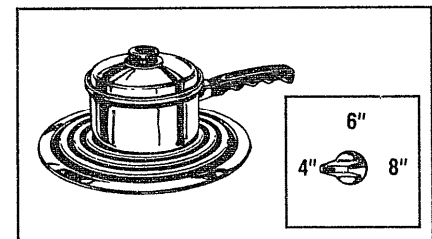

**SMALL**—4-inch unit. Turn switch to 4" when using small cooking utensils about 4 inches in diameter (as a 1-quart saucepan). Then select desired heat setting.

## Questions & Answers

**Q. May I can foods and preserves on my surface units?**

**A.** Yes, but only use cookware designed for canning purposes. Check the manufacturer's instructions and recipes for preserving foods. Be sure canner is flat-bottomed and fits over the center of your Calrod® unit. Since canning generates large amounts of steam, be careful to avoid burns from steam or heat. Canning should only be done on surface units.

**Q. Can I cover my drip pans with foil?**

**A.** No. Clean as recommended in Cleaning Guide.

**Q. Can I use special cooking equipment, like an oriental wok, on any surface units?**

**A.** Cookware without flat surfaces is not recommended. The life of your surface unit can be shortened, and the range top can be damaged from the high heat needed for this type of cooking.

**Q. Why am I not getting the heat I need from my units even though I have the knobs on the right setting?**

**A.** After turning surface unit off and making sure it is cool, check to make sure that your plug-in units are securely fastened into the surface connection.

**Q. Why does my cookware tilt when I place it on the surface unit?**

**A.** Because the surface unit is not flat. Make sure that the "feet" on your Calrod® units are sitting tightly in the range top indentation and the reflector ring is flat on the range surface.

**Q. Why is the porcelain finish on my cookware coming off?**

**A.** If you set your Calrod® unit higher than required for the cookware material, and leave it, the finish may smoke, crack, pop, or burn depending on the pot or pan. Also, a too high heat for long periods, and small amounts of dry food, may damage the finish.

## Home Canning Tips

**Canning should be done on cooktop only.**

In surface cooking of foods other than canning, the use of large-diameter pots (extending more than 1-inch beyond edge of trim ring) is not recommended. However, when canning with water-bath or pressure canner, large-diameter pots may be used. This is because boiling water temperatures (even under pressure) are not harmful to cooktop surfaces surrounding heating unit.

**HOWEVER, DO NOT USE LARGE DIAMETER CANNERS OR OTHER LARGE DIAMETER POTS FOR FRYING OR BOILING FOODS OTHER THAN WATER.** Most syrup or sauce mixtures—and all types of frying—cook at temperatures much higher than boiling water. Such temperatures could eventually harm cooktop surfaces surrounding heating units.

### Observe Following Points in Canning

**1.** Bring water to boil on **HIGH** heat, then after boiling has begun, adjust heat to lowest setting to maintain boil (saves energy and best uses surface unit.)

**2.** Be sure canner fits over center of surface unit. If your range does not allow canner to be centered on surface unit, use smaller-diameter pots for good canning results.

**3.** Flat-bottomed canners give best canning results. Be sure bottom of canner is flat or slight indentation fits snugly over surface unit. Canners with flanged or rippled bottoms (often found in enamelware) are not recommended.



**4.** When canning, use recipes from reputable sources. Reliable recipes are available from the manufacturer of your canner; manufacturers of glass jars for canning, such as Ball and Kerr; and the United States Department of Agriculture Extension Service.

**5.** Remember, in following the recipes, that canning is a process that generates large amounts of steam. Be careful while canning to prevent burns from steam or heat.

**NOTE:** If your range is being operated on low power (voltage), canning may take longer than expected, even though directions have been carefully followed. The process may be improved by: (1) using a pressure canner, and (2) for fastest heating of large water quantities, begin with **HOT** tap water.

# Surface Cooking Guide

## Cookware Tips

1. Use medium- or heavy-weight cookware. Aluminum cookware conducts heat faster than other metals. Cast iron and coated cast iron cookware is slow to absorb heat, but generally cooks evenly at LO or MEDIUM settings. Steel pans may cook unevenly if not combined with other metals.

Use non-stick or coated metal cookware. Flat ground Pyroceram® saucepans or skillets coated on the bottom with aluminum generally cook evenly. Use glass saucepans with heat-spreading trivets available for that purpose.

2. To conserve the most cooking energy, pans should be flat on the bottom, have straight sides and tight

fitting lids. Match the size of the saucepan to the size of the surface unit. A pan that extends more than an inch beyond the edge of the trim ring traps heat which causes "crazing" (fine hairline cracks) on porcelain, and discoloration ranging from blue to dark gray on chrome trim rings.

Food	Cookware	Directions and Setting to Start Cooking	Setting to Complete Cooking	Comments
<b>Cereal</b> Cornmeal, grits, oatmeal	Covered Saucepan	HI. In covered pan bring water to boil before adding cereal.	LO or WM, then add cereal. Finish timing according to package directions.	Cereals bubble and expand as they cook; use large enough saucepan to prevent boilover.
<b>Cocoa</b>	Uncovered Saucepan	HI. Stir together water or milk, cocoa ingredients. Bring just to a boil.	MED, to cook 1 or 2 minutes to completely blend ingredients.	Milk boils over rapidly. Watch as boiling point approaches.
<b>Coffee</b>	Percolator	HI. At first perk, switch heat to LO.	LO to maintain gentle but steady perk.	Percolate 8 to 10 minutes for 8 cups, less for fewer cups.
<b>Eggs</b> Cooked in shell	Covered Saucepan	HI. Cover eggs with cool water. Cover pan, cook until steaming.	LO. Cook only 3 to 4 minutes for soft cooked; 15 minutes for hard cooked.	If you do not cover skillet, baste eggs with fat to cook tops evenly.  Remove cooked eggs with slotted spoon or pancake turner.  Eggs continue to set slightly after cooking. For omelet do not stir last few minutes. When set, fold in half.
Fried sunny-side-up	Covered Skillet	MED HI. Melt butter, add eggs and cover skillet.	Continue cooking at MED HI until whites are just set, about 3 to 5 more minutes.	
Fried over easy	Uncovered Skillet	HI. Melt butter.	LO, then add eggs. When bottoms of eggs have just set, carefully turn over to cook other side.	
Poached	Covered Skillet	HI. In covered pan bring water to a boil.	LO. Carefully add eggs. Cook uncovered about 5 minutes at MED HI.	
Scrambled or omelets	Uncovered Skillet	HI. Heat butter until light golden in color.	MED. Add egg mixture. Cook, stirring to desired doneness.	
<b>Fruits</b>	Covered Saucepan	HI. In covered pan bring fruit and water to boil.	LO. Stir occasionally and check for sticking.	Fresh fruit: Use 1/4 to 1/2 cup water per pound of fruit. Dried fruit: Use water as package directs. Time depends on whether fruit has been presoaked. If not, allow more cooking time.
<b>Meats, Poultry</b> Braised: Pot roasts of beef, lamb or veal; pork steaks and chops	Covered Skillet	HI. Melt fat, then add meat. Switch to MED HI to brown meat. Add water or other liquid.	LO. Simmer until fork tender.	Meat can be seasoned and floured before it is browned, if desired. Liquid variations for flavor could be wine, fruit or tomato juice or meat broth. Timing: Steaks 1 to 2-inches: 1 to 2 hours. Beef Stew: 2 to 3 hours. Pot Roast: 2 1/2 to 4 hours.
Pan-fried: Tender chops; thin steaks up to 3/4-inch; minute steaks; hamburgers; franks and sausage; thin fish fillets	Uncovered Skillet	HI. Preheat skillet, then grease lightly.	MED HI or MED. Brown and cook to desired doneness, turning over as needed.	Pan frying is best for thin steaks and chops. If rare is desired, pre-heat skillet before adding meat.

**Deep Fat Frying.** Do not overfill kettle with fat that may spill over when adding food. Frosty foods bubble vigorously. Watch foods frying at **HIGH** temperatures and keep range and hood clean from accumulated grease.

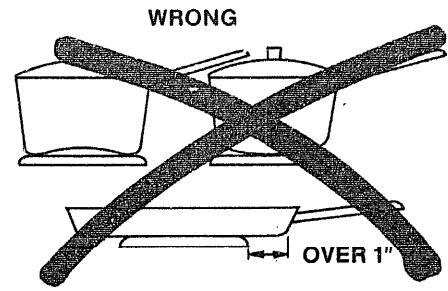
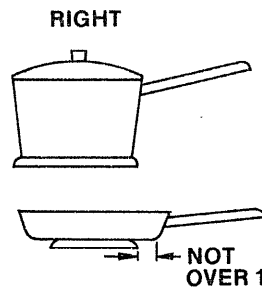

Food	Cookware	Directions and Setting to Start Cooking	Setting to Complete Cooking	Comments
Fried Chicken	Covered Skillet	HI. Melt fat. Switch to MED HI to brown chicken.	LO. Cover skillet and cook until tender. Uncover last few minutes.	For crisp dry chicken, cover only after switching to LO for 10 minutes. Uncover and cook, turning occasionally 10 to 20 minutes.
Pan fried bacon	Uncovered Skillet	HI. In cold skillet, arrange bacon slices. Cook just until starting to sizzle.	MED HI. Cook, turning over as needed.	A more attention-free method is to start and cook at MED.
Sauteed: Less tender thin steaks (chuck, round, etc.); liver; thick or whole fish	Covered Skillet	HI. Melt fat. Switch to MED to brown slowly.	LO. Cover and cook until tender.	Meat may be breaded or marinated in sauce before frying.
Simmered or stewed meat; chicken; corned beef; smoked pork; stewing beef; tongue; etc.	Covered Dutch Oven, Kettle or Large Saucepan	HI. Cover meat with water and cover pan or kettle. Cook until steaming.	LO. Cook until fork tender. (Water should slowly boil). For very large loads, medium heat may be needed.	Add salt or other seasoning before cooking if meat has not been smoked or otherwise cured.
Melting chocolate, butter, marshmallows	Small Uncovered Saucepan. Use small surface unit	WM. Allow 10 to 15 minutes to melt through. Stir to smooth.		When melting marshmallows, add milk or water.
Pancakes or French toast	Skillet or Griddle	MED HI. Heat skillet 8 to 10 minutes. Grease lightly.	Cook 2 to 3 minutes per side.	Thick batter takes slightly longer time. Turn over pancakes when bubbles rise to surface.
Pasta Noodles or spaghetti	Covered Large Kettle or Pot	HI. In covered kettle, bring salted water to a boil, uncover and add pasta slowly so boiling does not stop.	MED HI. Cook uncovered until tender. For large amounts, HI may be needed to keep water at rolling boil throughout entire cooking time.	Use large enough kettle to prevent boilover. Pasta doubles in size when cooked.
Pressure Cooking	Pressure Cooker or Canner	HI. Heat until first jiggle is heard.	MED HI for foods cooking 10 minutes or less. MED for foods over 10 minutes.	Cooker should jiggle 2 to 3 times per minute.
Puddings, Sauces, Candies, Frostings	Uncovered Saucepan	HI. Bring just to boil.	LO. To finish cooking.	Stir frequently to prevent sticking.
Vegetables Fresh	Covered Saucepan	HI. Measure 1/2 to 1 inch water in saucepan. Add salt and prepared vegetable. In covered saucepan bring to boil.	MED. Cook 1 pound 10 to 30 or more minutes, depending on tenderness of vegetable.	Uncovered pan requires more water and longer time.
Frozen	Covered Saucepan	HI. Measure water and salt as above. Add frozen block of vegetable. In covered saucepan bring to boil.	LO. Cook according to time on package.	Break up or stir as needed while cooking.
Sauteed: Onions; green peppers; mushrooms; celery; etc.	Uncovered Skillet	HI. In skillet melt fat.	MED. Add vegetable. Cook until desired tenderness is reached.	Turn over or stir vegetable as necessary for even browning.
Rice and Grits	Covered Saucepan	HI. Bring salted water to a boil.	WM. Cover and cook according to time.	Triple in volume after cooking. Time at WM. Rice: 1 cup rice and 2 cups water—25 minutes. Grits: 1 cup grits and 4 cups water—40 minutes.

# Automatic Timer and Clock

The Automatic Timer and Clock on your oven are helpful devices that serve several purposes.

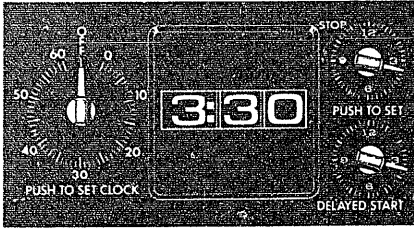

## To Set the Clock

Push in the center knob of the Minute Timer and turn knob in either direction to set the Digital Clock numerals to the correct time.

(After setting the Clock, let the knob out, and turn the Minute Timer pointer to OFF.)

## To Set the Minute Timer

The Minute Timer is the large dial to the left of the Digital Clock. Use it to time all your precise cooking operations. This dial also sets or changes the Digital Clock.

TO SET THE MINUTE TIMER, turn the center knob clockwise, *without pushing in*, until pointer reaches number of minutes you wish to time (up to 60).

## Time Bake Uses Automatic Timer

Using Automatic Timer, you can TIME BAKE with the oven starting immediately and turning off at the Stop Time set or you can set both DELAYED START (some models say START) and STOP dials to automatically start and stop oven at a later time of day. It takes the worry out of not being home to start or stop the oven.

Setting the dials for TIME BAKE is explained in detail on page 14.

## Self-Clean Uses Automatic Timer

The self-cleaning function on your oven uses the Automatic Timer to set the length of time needed to clean whether you wish to clean immediately or delay the cleaning until low energy times such as during the night. See page 20.

## Questions and Answers

**Q. How can I use my Minute Timer to make my surface cooking easier?**

**A.** Your Minute Timer will help time total cooking which includes time to boil food and change temperatures. Do not judge cooking time by visible steam only. Food will cook in covered containers even though you can't see any steam.

**Q. Must the Clock be set on correct time of day when I wish to use the Automatic Timer for baking?**

**A.** Yes, if you wish to set the DELAYED START or STOP dials to turn on and off at set times during timed functions.

**Q. Can I use the Minute Timer during oven cooking?**

**A.** The Minute Timer can be used during any cooking function. The Automatic Timers (DELAYED START and STOP dials) are used with TIME BAKE function only.

**Q. Can I change the Clock while I'm Time Cooking in the oven?**

**A.** No. The Clock cannot be changed during any program that uses the oven timer. You must either stop those programs or wait until they are finished before changing time.

# Using Your Oven

## Before Using Your Oven

1. Look at the controls. Be sure you understand how to set them properly. Read over the directions for the Automatic Oven Timer so you understand its use with the controls.
2. Check oven interior. Look at the shelves. Take a practice run at removing and replacing them properly, to give sure, sturdy support.
3. Read over information and tips that follow.
4. Keep this book handy so you can refer to it, especially during the first weeks of getting acquainted with your range.

## Oven Controls

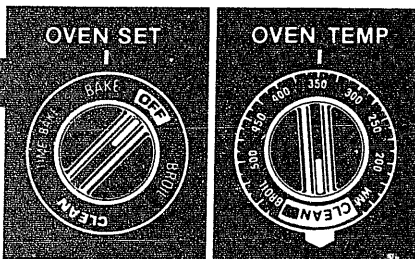

The controls for the oven are marked **OVEN SET** and **OVEN TEMP**. The **OVEN SET** control has settings for **BAKE**, **TIME BAKE**, **BROIL**, **CLEAN** and **OFF**. When you turn the knob to the desired setting, the proper heating units are then activated for that operation.

The **OVEN TEMP** control maintains the temperature you set, from **WARM (150°F.)** to **BROIL (550°F.)** and also at **CLEAN (880°F.)**.

The **Oven Cycling Light** glows until the oven reaches your selected temperature, then goes off and on with the oven unit(s) during cooking.

**PREHEATING** the oven, even to high temperature settings, is speedy—rarely more than about 10 minutes. Preheat the oven only when necessary. Most foods will cook satisfactorily without preheating. If you find preheating is necessary, keep an eye on the indicator light and put food in the oven promptly after the light goes out.

## Oven Interior Shelves

The shelves are designed with stop-locks so that when placed **correctly** on the shelf supports, they (a) will stop before coming completely from the oven, and (b) **will not tilt** when removing food from or placing food on them.

**To remove shelf from the oven**, lift up rear of shelf, pull forward with stop-locks (curved extension under shelf) along **top** of shelf supports. Be certain that shelf is cool before touching.

**To replace shelf in oven**, insert shelf with stop-locks resting on shelf supports. Push shelf toward rear of oven; it will fall into place. When shelf is in proper position, stop-locks on shelf will run under shelf support when shelf is pulled forward.

## Shelf Positions

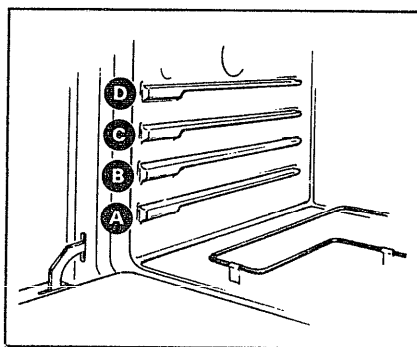

The oven has four shelf supports—**A** (bottom), **B**, **C** and **D** (top). Shelf positions for cooking food are suggested on **Baking**, **Roasting** and **Broiling** pages.

## Oven Light

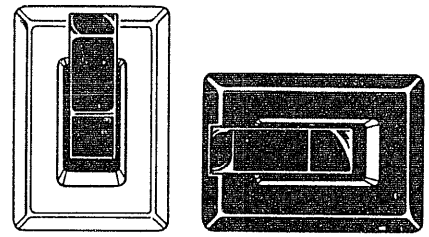

The light comes on automatically when the door is opened. Use switch on front of door to turn light on and off when door is closed.

## Lamp over Surface Unit (Models JB500 and JB490)

Press the lamp switch button to light the lamp. Be sure to hold button depressed until light comes on.

# Baking

When cooking a food for the first time in your new oven, use the time given on recipes as a guide. Oven thermostats may "drift" from the factory setting over the years, and 5- to 10-minute differences in timing between an old and new oven are not unusual. You might think your new oven is not performing correctly; however, it has been set correctly at the factory and is more likely to be accurate than the oven it replaced.

## How to Set Your Range for Baking

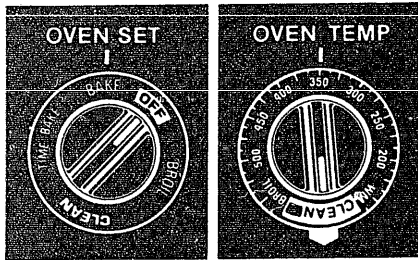

1. Place food in oven, being sure to leave about 1" between pans and oven walls for good circulation of heat. Close oven door, and avoid frequent door openings during baking to prevent undesirable results.

2. Turn OVEN SET knob to BAKE and OVEN TEMP knob to temperature on recipe or Baking Guide.

3. Check food for doneness at minimum time on recipe. Cook longer if necessary. Switch off heat and remove foods.

## How to Time Bake

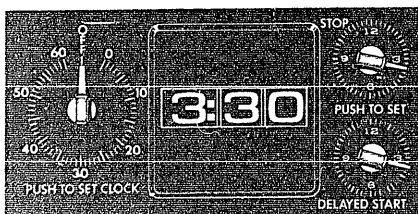

The oven timer controls are designed to turn the oven on and

off automatically at specific times you want baking to start and stop. The oven cycling light will stay on while using the Time Bake selection.

Your Time Bake options:

**Immediate Start & Automatic Stop.** Oven turns on right away and turns off automatically at your preset stop time.

**Delayed Start & Stop.** Oven automatically turns on later at your preset start time and turns off at your preset stop time.

Remember when setting stop time that time-baked foods will continue cooking after the oven turns off.

## How to Set Immediate Start and Automatic Stop

Before beginning, make sure the range clock shows the correct time of day.

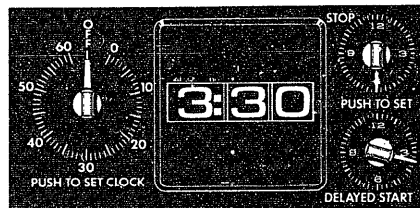

1. To set Stop Time, push in knob on Stop dial and turn pointer to time you want oven to turn off; for example, 6:00. The DELAYED START dial should be at the same position as the time of day on clock.

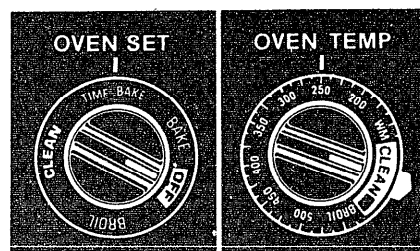

2. Turn OVEN SET knob to TIME BAKE. Turn OVEN TEMP knob to desired oven temperature; for example, 250°F. The oven will start immediately and will stop at the time you have set.

## How to Set Delayed Start and Stop

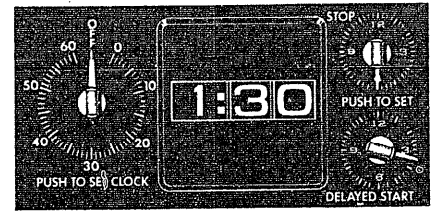

1. To set Start Time, push in knob on DELAYED START dial (some models may say START) and turn pointer to time you want oven to turn on; for example, 3:30.

2. To set Stop Time, push in knob on Stop dial and turn pointer to time you want oven to turn off; for example, 6:00. This means your recipe called for 2½ hours of baking time.

NOTE: Time on STOP dial must be later than time shown on range clock and DELAYED START dial.

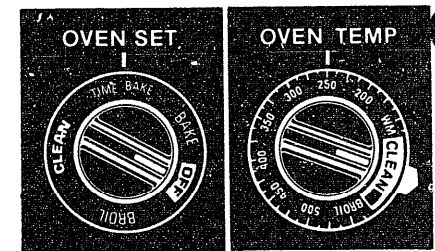

3. Turn OVEN SET knob to TIME BAKE. Turn OVEN TEMP knob to 250°F. or recommended temperature.

Place food in oven, close the door and the oven will be turned on and off automatically at the times you have set. Turn OVEN SET to OFF and remove food from oven.

OVEN INDICATOR LIGHT(s) at TIME BAKE setting may work differently than they do at BAKE setting. Carefully recheck the steps given above. If all operations are done as explained, the oven will operate as it should.

# Baking Guide

1. Aluminum pans conduct heat quickly. For most conventional baking, light, shiny finishes generally give best results. They prevent overbrowning in the time it takes for heat to cook the center areas. Dull (satin-finish) bottom surfaces of pans are recommended for cake pans and pie plates to be sure those areas brown completely.

2. Dark or non-shiny finishes, glass and Pyroceram® cookware, generally absorb heat, which may result in dry, crisp crusts. Reduce oven heat 25°F. if lighter crusts are desired. Preheat cast iron for baking some foods for rapid browning when food is added.

3. Preheating the oven is not always necessary, especially for foods

which cook longer than 30 to 40 minutes. For food with short cooking times, preheating gives best appearance and crispness.

4. Open the oven door to check food as little as possible to prevent uneven heating and to save energy.

Food	Container	Shelf Position	Oven Temperature	Time, Minutes	Comments
<b>Bread</b>					
Biscuits (½-in. thick)	Shiny Cookie Sheet	B, C	400°-475°	15-20	Canned, refrigerated biscuits take 2 to 4 minutes less time.
Coffee cake	Shiny Metal Pan with satin-finish bottom	B, A	350°-400°	20-30	
Corn bread or muffins	Cast Iron or Glass	B	400°-450°	20-40	Preheat cast iron pan for crisp crust.
Gingerbread	Shiny Metal Pan with satin-finish bottom	B	350°	45-55	
Muffins	Shiny Metal Muffin Pans	A, B	400°-425°	20-30	
Popovers	Deep Glass or Cast Iron Cups	B	375°	45-60	Decrease about 5 minutes for muffin mix, or bake at 450°F. for 25 minutes, then at 350°F. for 10 to 15 minutes.
Quick loaf bread	Metal or Glass Loaf Pans	B	350°-375°	45-60	
Yeast bread (2 loaves)	Metal or Glass Loaf Pans	A, B	375°-425°	45-60	Dark metal or glass give deepest browning.
Plain rolls	Shiny Oblong or Muffin Pans	A, B	375°-425°	10-25	For thin rolls, Shelf B may be used.
Sweet rolls	Shiny Oblong or Muffin Pans	B, A	350°-375°	20-30	For thin rolls, Shelf B may be used.
<b>Cakes</b> (without shortening)					
Angel food	Aluminum Tube Pan	A	325°-375°	30-55	Two-piece pan is convenient.
Jelly roll	Metal Jelly Roll Pan	B	375°-400°	10-15	Line pan with waxed paper.
Sponge	Metal or Ceramic Pan	A	325°-350°	45-60	
<b>Cakes</b>					
Bundt cakes	Metal or Ceramic Pan	A, B	325°-350°	45-65	
Cupcakes	Shiny Metal Muffin Pans	B	350°-375°	20-25	Paper liners produce more moist crusts.
Fruit cakes	Metal or Glass Loaf or Tube Pan	A, B	275°-300°	2-4 hrs.	Use 300°F. and Shelf B for small or individual cakes.
Layer	Shiny Metal Pan with satin-finish bottom	B	350°-375°	20-35	
Layer, chocolate	Shiny Metal Pan with satin-finish bottom	B	350°-375°	25-30	
Loaf	Metal or Glass Loaf Pans	B	350°	40-60	
<b>Cookies</b>					
Brownies	Metal or Glass Pans	B, C	325°-350°	25-35	Bar cookies from mix use same time.
Drop	Cookie Sheet	B, C	350°-400°	10-20	Use Shelf C and increase temp.
Refrigerator	Cookie Sheet	B, C	400°-425°	6-12	25°F. to 50°F. for more browning.
Rolled or sliced	Cookie Sheet	B, C	375°-400°	7-12	
<b>Fruits, Other Desserts</b>					
Baked apples	Glass or Metal Pan	A, B, C	350°-400°	30-60	
Custard	Glass Custard Cups or Casserole (set in pan of hot water)	B	300°-350°	30-60	Reduce temp. to 300°F. for large custard. Cook bread or rice pudding with custard base 80 to 90 minutes.
Puddings, Rice and Custard	Glass Custard Cups or Casserole	B	325°	50-90	
<b>Pies</b>					
Frozen	Foil Pan on Cookie Sheet	A	400°-425°	45-70	Large pies use 400°F. and increase time.
Meringue	Spread to crust edges	B, A	325°-350°	15-25	To quickly brown meringue, use 400°F. for 8 to 10 minutes.
One crust	Glass or Satin-finish Metal	A, B	400°-425°	40-60	Custard fillings require lower temperature, longer time.
Two crust	Glass or Satin-finish Metal	B	400°-425°	40-60	
Pastry shell	Glass or Satin-finish Metal	B	450°	12-15	
<b>Miscellaneous</b>					
Baked potatoes	Set on Oven Shelf	A, B, C	325°-400°	60-90	Increase time for large amount or size.
Scalloped dishes	Glass or Metal Pan	A, B, C	325°-375°	30-60	
Souffles	Glass	B	300°-350°	30-75	



# Roasting

Roasting is cooking by dry heat. Tender meat or poultry can be roasted uncovered in your oven. Roasting temperatures, which should be low and steady, keep spattering to a minimum. When roasting, it is not necessary to sear, baste, cover or add water to your meat.

Roasting is really a baking procedure used for meats. Therefore, oven controls are set to **BAKE** or **TIME BAKE**. (You may hear a slight clicking sound, indicating the oven is working properly.) Roasting is easy; just follow these steps:

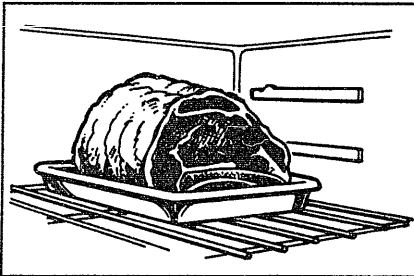

**Step 1:** Check weight of meat, and place, fat side up, on roasting rack in a shallow pan. (Broiler pan with rack is a good pan for this.) Line broiler pan with aluminum foil when using pan for marinating, cooking with fruits, cooking heavily cured meats, or for basting food during cooking. Avoid spilling these materials on oven liner or door.

**Step 2:** Place in oven on shelf in A or B position. No preheating is necessary.

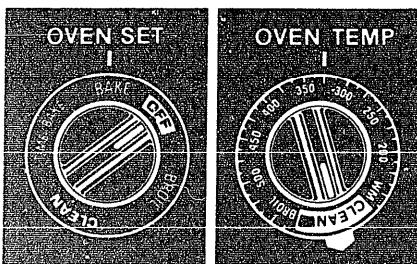

**Step 3:** Turn **OVEN SET** to **BAKE** and **OVEN TEMP** to 325°F. Small poultry may be cooked at 375°F for best browning.

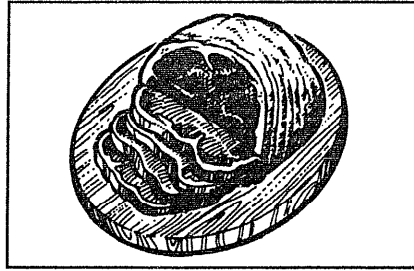

**Step 4:** Most meats continue to cook slightly while standing, after being removed from the oven. Standing time recommended for roasts is 10 to 20 minutes to allow roast to firm up and make it easier to carve. Internal temperature will rise about 5° to 10°F.; to compensate for temperature rise, if desired, remove roast from oven at 5° to 10°F. less than temperature on guide.

**NOTE:** You may wish to use **TIME BAKE**, as described on page 14, to turn oven on and off automatically.

Remember that food will continue to cook in the hot oven and therefore should be removed when the desired internal temperature has been reached.

## For Frozen Roasts

- Frozen roasts of beef, pork, lamb, etc., can be started without thawing, but allow 10 to 25 minutes per pound additional time (10 minutes per pound for roasts under 5 pounds, more time for larger roasts).

- Thaw most frozen poultry before roasting to ensure even doneness. Some commercial frozen poultry can be cooked successfully without thawing. Follow directions given on packer's label.

## Questions and Answers

**Q. Is it necessary to check for doneness with a meat thermometer?**

**A.** Checking the finished internal temperature at the completion of cooking time is recommended. Temperatures are shown in Roasting Guide on opposite page. For roasts over 8 pounds, cooked at 300°F. with reduced time, check with thermometer at half-hour intervals after half the time has passed.

**Q. Why is my roast crumbling when I try to carve it?**

**A.** Roasts are easier to slice if allowed to cool 10 to 20 minutes after removing from oven. Be sure to cut across the grain of the meat.

**Q. Do I need to preheat my oven each time I cook a roast or poultry?**

**A.** It is rarely necessary to preheat your oven, only for very small roasts, which cook a short length of time.

**Q. When buying a roast, are there any special tips that would help me cook it more evenly?**

**A.** Yes. Buy a roast as even in thickness as possible, or buy rolled roasts.

**Q. Can I seal the sides of my foil "tent" when roasting a turkey?**

**A.** Sealing the foil will steam the meat. Leaving it unsealed allows the air to circulate and brown the meat.

# Roasting Guide

## Roasting

1. Position oven shelf at B for small-size roasts (3 to 7 lbs.) and at A for larger roasts.

2. Place meat fat-side up, or poultry breast-side up, on broiler pan or other shallow pan with trivet. Do not cover. Do not stuff poultry until just before roasting. Use meat probe for more accurate doneness. Contro<sup>1</sup> signals when food has reached set temperature. (Do not place probe in stuffing.)

3. Remove fat and drippings as necessary. Baste as desired.

4. **Standing time** recommended for roasts is 10 to 20 minutes to allow roast to firm up and make it easier to carve. Internal temperature will rise about 5° to 10°F.; to compensate for temperature rise, if desired, remove roast from oven at 5° to 10°F. less than temperature on guide.

5. **Frozen roasts** can be conventionally roasted by adding 10 to 25 minutes per pound more time than given in guide for refrigerated roasts. (10 minutes per pound for roasts under 5 pounds.) Defrost poultry before roasting.

Type	Oven Temperature	Doneness	Approximate Roasting Time, in Minutes per Pound		Internal Temperature °F
<b>Meat</b>			<b>3 to 5-lbs.</b>	<b>6 to 8-lbs.</b>	
Tender cuts; rib, high quality sirloin tip, rump or top round*	325°	Rare: Medium: Well Done:	24-30 30-35 35-45	18-22 22-25 28-33	130°-140° 150°-160° 170°-185°
Lamb Leg or bone-in shoulder*	325°	Rare: Medium: Well Done:	21-25 25-30 30-35	20-23 24-28 28-33	130°-140° 150°-160° 170°-185°
Veal shoulder, leg or loin*	325°	Well Done:	35-45	30-40	170°-180°
Pork loin, rib or shoulder*	325°	Well Done:	35-45	30-40	170°-180°
Ham, precooked	325°	To Warm:	10 minutes per pound (any weight)		125°-130°
Ham, raw	325°	Well Done:	<b>Under 10-lbs.</b> 20-30	<b>10 to 15-lbs.</b> 17-20	160°
*For boneless rolled roasts over 6-inches thick, add 5 to 10 minutes per pound to times given above.					
<b>Poultry</b>			<b>3 to 5-lbs.</b>	<b>Over 5-lbs.</b>	
Chicken or Duck	325°	Well Done:	35-40	30-35	185°-190°
Chicken pieces	375°	Well Done:	35-40		185°-190°
Turkey	325°	Well Done:	<b>10 to 15-lbs.</b> 20-25	<b>Over 15-lbs.</b> 15-20	<b>In thigh:</b> 185°-190°

# Broiling

Broiling is cooking food by intense radiant heat from the upper unit in the oven. Most fish and tender cuts of meat can be broiled. Follow these steps to keep spattering and smoking to a minimum.

**Step 1:** If meat has fat or gristle near edge, cut vertical slashes through both about 2" apart. If desired, fat may be trimmed, leaving layer about 1/8" thick.

**Step 2:** Place meat on broiler rack in broiler pan which comes with range. Always use rack so fat drips into broiler pan; otherwise juices may become hot enough to catch fire.

**Step 3:** Position shelf on recommended shelf position as suggested in Broiling Guide on opposite page. Most broiling is done on C position, but if your range is connected to 208 volts, you may wish to use higher position.

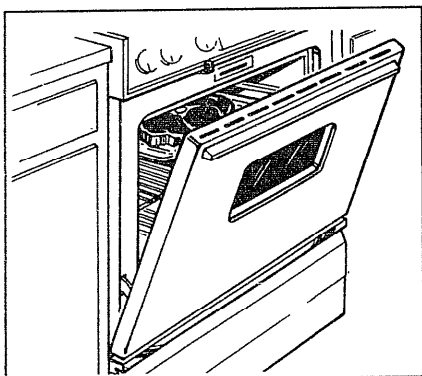

**Step 4:** Leave door ajar a few inches (except when broiling chicken). The door stays open by itself, yet the proper temperature is maintained in the oven.

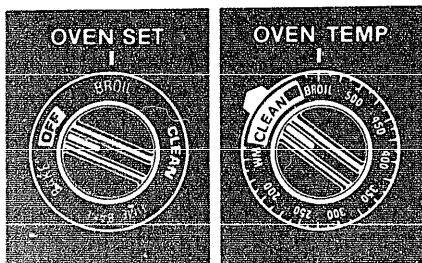

**Step 5:** Turn both OVEN SET and OVEN TEMP knobs to BROIL. Preheating units is not necessary. (See notes in Broiling Guide.)

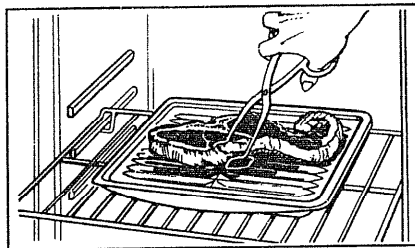

**Step 6:** Turn food only once during cooking. Time foods for first side per Broiling Guide.

Turn food, then use times given for second side as a guide to preferred doneness. (Where two thicknesses and times are given together, use first times given for thinnest food.)

**Step 7:** Turn OVEN SET knob to OFF. Serve food immediately, and leave pan outside oven to cool during meal for easiest cleaning.

## Use of Aluminum Foil

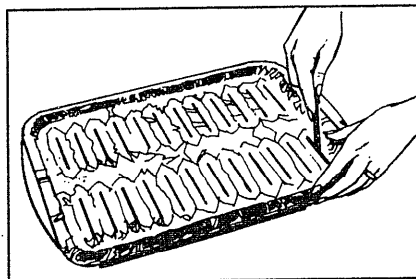

1. If desired, broiler pan may be lined with foil and broiler rack may be covered with foil for broiling. **ALWAYS BE CERTAIN TO MOLD FOIL THOROUGHLY TO BROILER RACK, AND SLIT FOIL TO CONFORM WITH SLITS IN RACK.** Broiler rack is designed to minimize smoking and spattering, and to keep drippings cool during broiling. Stopping fat and meat juices from draining to the broiler pan prevents rack from serving its purpose, and juices may become hot enough to catch fire.

2. **DO NOT** place a sheet of aluminum foil on shelf. To do so may result in improperly cooked foods, damage to oven finish and increase in heat on outside surfaces of the oven.

## Questions & Answers

**Q. Why should I leave the door closed when broiling chicken?**

**A.** Chicken is the only food recommended for closed-door broiling. This is because chicken is relatively thicker than other foods you broil. Closing the door holds more heat in the oven which allows chicken to cook evenly throughout.

**Q. When broiling, is it necessary to always use a rack in the pan?**

**A.** Yes. Using the rack suspends the meat over the pan. As the meat cooks, the juices fall into the pan, thus keeping meat drier. Juices are protected by the rack and stay cooler, thus preventing excessive spatter and smoking.

**Q. Should I salt the meat before broiling?**

**A.** No. Salt draws out the juices and allows them to evaporate. Always salt after cooking. Turn meat with tongs; piercing meat with a fork also allows juices to escape. When broiling poultry or fish, brush each side often with butter.

**Q. Why are my meats not turning out as brown as they should?**

**A.** In some areas, the power (voltage) to the range may be low. In these cases, preheat the broil unit for 10 minutes before placing broiler pan with food in oven. Check to see if you are using the recommended shelf position. Broil for longest period of time indicated in the Broiling Guide. Turn food only once during broiling.

**Q. Do I need to grease my broiler rack to prevent meat from sticking?**

**A.** No. The broiler rack is designed to reflect broiler heat, thus keeping the surface cool enough to prevent meat sticking to the surface. However, spraying the broiler rack lightly with a vegetable cooking spray before cooking will make cleanup easier.

# Broiling Guide

## Broiling

1. Always use broiler pan and rack that comes with your oven. It is designed to minimize smoking and spattering by trapping juices in the shielded lower part of the pan.
2. Oven door should be ajar for all foods except chicken; there is a special position on door which holds door open correctly.
3. For steaks and chops, slash fat evenly around outside edges of meat.

To slash, cut crosswise through outer fat surface just to the edge of the meat. Use tongs to turn meat over to prevent piercing meat and losing juices.

4. If desired, marinate meats or chicken before broiling. Or brush with barbecue sauce last 5 to 10 minutes only.
5. When arranging food on pan, do not let fatty edges hang over sides, which could soil oven with fat dripping.

6. Broiler does not need to be preheated. However, for very thin foods, or to increase browning, preheat if desired.

7. **Frozen Steaks** can be conventionally broiled by positioning the oven shelf at next lowest shelf position and increasing cooking time given in this guide 1½ times per side.

8. If your oven is connected to 208 volts, rare steaks may be broiled by preheating broil heater and positioning the oven shelf one position higher.

Food	Quantity and/or Thickness	Shelf Position	First Side Time, Minutes	Second Side Time, Minutes	Comments
<b>Bacon</b>	½-lb. (about 8 thin slices)	C	3½	3½	Arrange in single layer.
<b>Ground Beef Well Done</b>	1-lb. (4 patties) ½ to ¾-in. thick	C	7	4-5	Space evenly. Up to 8 patties take about same time.
<b>Beef Steaks</b>					
Rare	1-inch thick	C	7	7	Steaks less than 1 inch cook through before browning. Pan frying is recommended. Slash fat.
Medium	(1 to 1½-lbs.)	C	9	9	
Well Done		C	13	13	
Rare	1½-in. thick	C	10	7-8	
Medium	(2 to 2½-lbs.)	C	15	14-16	
Well Done		C	25	20-25	
<b>Chicken</b>	1 whole (2 to 2½-lbs.), split lengthwise	A	35	10-15	Reduce times about 5 to 10 minutes per side for cut-up chicken. Brush each side with melted butter. Broil with skin down first and broil with door closed.
<b>Bakery Products</b>					
Bread (Toast) or Toaster Pastries	2 to 4 slices 1 pkg. (2)	C	1½-2	½	Space evenly. Place English muffins cut-side-up and brush with butter, if desired.
English Muffins	2 (split)	C	3-4		
<b>Lobster Tails</b> (6 to 8-oz. each)	2-4	B	13-16	Do not turn over.	Cut through back of shell. Spread open. Brush with melted butter before and after half time.
<b>Fish</b>	1-lb. fillets ¼ to ½-in. thick	C	5	5	Handle and turn very carefully. Brush with lemon butter before and during cooking if desired. Preheat broiler to increase browning.
<b>Ham Slices</b> (precooked)	1-in. thick	B	8	8	Increase times 5 to 10 minutes per side for 1½-inch thick or home cured.
<b>Pork Chops</b> Well Done	2 (½ inch) 2 (1-in. thick) about 1 lb.	C B	10 13	10 13	Slash fat.
<b>Lamb Chops</b>					
Medium	2 (1 inch)	C	8	4-7	Slash fat.
Well Done	about 10 to 12 oz.	C	10	10	
Medium	2 (1½ inch)	C	10	4-6	
Well Done	about 1 lb.	B	17	12-14	
<b>Wieners and similar</b> precooked sausages, bratwurst	1-lb. pkg. (10)	C	6	1-2	If desired, split sausages in half lengthwise; cut into 5 to 6-inch pieces.

# Operating the Self-Cleaning Oven

## Before Setting Oven Controls, Check These Things:

### Step 1:

Remove broiler pan, broiler rack and other cookware from the oven. (Oven shelves may be left in oven. Note: Shelves will discolor after the self-clean cycle.)

### Step 2:

Wipe up heavy soil on oven bottom.

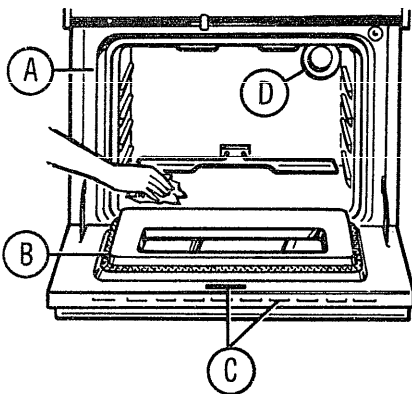

- A. Oven Front Frame
- B. Oven Door Gasket
- C. Openings in Door
- D. Oven Light

### Step 3:

Clean spatters or spills on oven front frame (A) and oven door outside gasket (B) with a dampened cloth. Polish with a dry cloth. Do not clean gasket (B). Do not allow water to run down through openings in top of door (C). Never use a commercial oven cleaner in or around self-cleaning oven.

### Step 4:

Close oven door and make sure oven light (D) is off.

### Step 5:

The aluminum or porcelain-enameled drip pans that came with your range can be cleaned automatically in the self-cleaning oven, but the aluminum pans may eventually change color. Wipe off boilovers that are not stuck on before placing two pans, *upside down*, on each oven shelf.

**Caution:** Chrome trim rings around the surface units should never be cleaned in the self-cleaning oven. Neither should reflector pans of foil or shiny chrome.

## How to Set Oven for Cleaning

### Step 1:

Turn **OVEN SET** and **OVEN TEMP** knobs to **CLEAN**. Controls will snap into final position when the **CLEAN** location is reached.

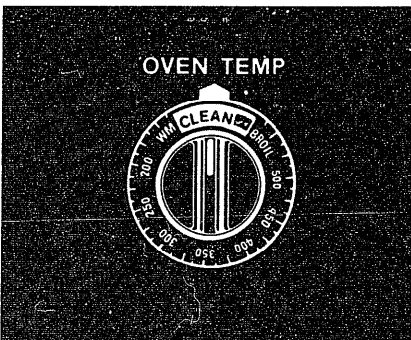

### Step 2:

Slide the **LATCH HANDLE** to the right as far as it will go.

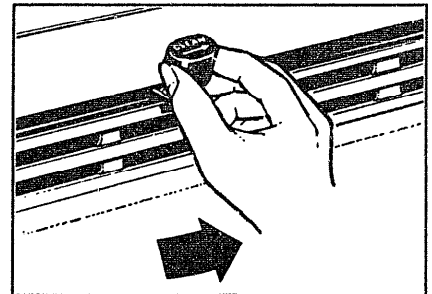

### Step 3:

Set the automatic oven timer:

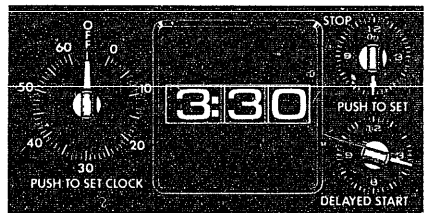

- Make sure both the range clock and the **DELAYED START** dial show the correct time of day. When the **DELAYED START** knob is pushed in and turned, it will "pop" into place when the time shown on the range clock is reached.

- Decide on cleaning hours necessary.

Recommended Cleaning Time:

**Moderate Soil—2 hours**  
(thin spills and light spatter)

**Heavy Soil—3 hours**  
(heavy, greasy spills and spatter)

- Add these hours to present time of day, then push in and turn **STOP** dial clockwise to this desired stop time. **CLEANING** light glows, showing cleaning is starting.

The **LOCKED** light will glow, indicating oven is hot and door cannot be opened. Oven door and window get hot during self-cleaning. **DO NOT TOUCH.**

## Follow These Steps after Self-Cleaning

After cleaning is complete, the door will stay locked until the oven cools and the LOCKED light goes off. This takes about 30 minutes.

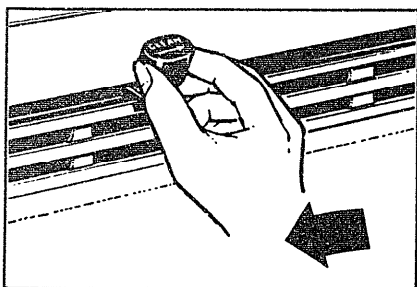

### Step 1:

When LOCKED light is off, slide the LATCH HANDLE to the left as far as it will go and open the door.

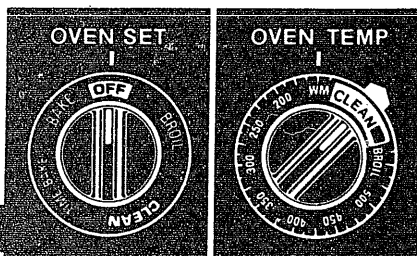

### Step 2:

Turn OVEN SET knob to OFF.

### Step 3:

Turn OVEN TEMP knob to WARM.

**NOTE:** If you wish to start and stop cleaning at a later time than shown on clock, push in and turn DELAYED START dial to time you wish to start. Add the hours needed for cleaning to this "start" time, then push in and turn STOP dial to this desired stop time. Oven will automatically turn on and off at the set times.

## Questions and Answers

**Q. Why won't my oven clean immediately even though I set all the time and clean knobs correctly?**

**A.** Check to be sure your DELAYED START dial is set to the same time as the range clock. Also check to be sure LATCH HANDLE is moved to the right.

**Q. If my oven clock is not working, can I still self-clean my oven?**

**A.** No. Your Automatic Oven Timer uses the range clock to help start and stop your self-cleaning cycle.

**Q. Can I use commercial oven cleaners on any part of my self-cleaning oven?**

**A.** No cleaners or coatings should be used around any part of this oven. If you do use them and do not wipe the oven absolutely clean, the residue can scar the oven surface and damage metal parts the next time the oven is automatically cleaned.

**Q. Can I clean the Woven Gasket around the oven door?**

**A.** No, this gasket is essential for a good oven seal, and care must be taken not to rub, damage or move this gasket.

**Q. After having just used the oven, the LOCKED light came on and I could not move the LATCH HANDLE. Why?**

**A.** After several continuous high-temperature bakings or broilings, the LOCKED light may come on. The oven door can't be latched for self-cleaning while the LOCKED light is on. If this happens, let the oven cool until the LOCKED light goes off. Then the oven door can be latched for self-cleaning.

**Q. What should I do if excessive smoking occurs during cleaning?**

**A.** This is caused by excessive soil, and you should switch the OVEN SET knob to OFF. Open windows to rid room of smoke. Allow the

oven to cool for at least one hour before opening the door. Wipe up the excess soil and reset the clean cycle.

**Q. Is the "crackling" sound I hear during cleaning normal?**

**A.** Yes. This is the metal heating and cooling during both the cooking and cleaning functions.

**Q. Should there be any odor during the cleaning?**

**A.** Yes, there may be a slight odor during the first few cleanings. Failure to wipe out excessive soil might also cause an odor when cleaning.

**Q. What causes the hair-like lines on the enameled surface of my oven?**

**A.** This is a normal condition resulting from heating and cooling during cleaning. They do not affect how your oven performs.

**Q. Why do I have ash left in my oven after cleaning?**

**A.** Some types of soil will leave a deposit which is ash. It can be removed with a damp sponge or cloth.

**Q. My oven shelves do not slide easily. What is the matter?**

**A.** After many cleanings, oven shelves may become so clean they do not slide easily. If you wish shelves to slide more easily, dampen fingers with a small amount of cooking oil and rub lightly over sides of shelf where they contact shelf supports.

**Q. My oven shelves have become gray after the self-clean cycle. Is this normal?**

**A.** Yes. After the self-clean cycle, the shelves may lose some luster and discolor to a deep gray color.

**Q. Can I cook food on the cooktop while the oven is self-cleaning?**

**A.** Yes. While the oven is self-cleaning, you can use the cooktop just as you normally do.

# Care and Cleaning

Proper care and cleaning are important so your range will give you efficient and satisfactory service. Follow these directions carefully in caring for your range to assure safe and proper maintenance.

## Finishes

The porcelain enamel finish is sturdy but breakable if misused. This finish is acid-resistant. However, any acid foods spilled (such as fruit juices, tomato, or vinegar) should not be permitted to remain on the finish.

## Cleaning Under the Range

The area under the range of models equipped with a bottom drawer can be reached easily for cleaning by removing the bottom drawer. To remove, pull drawer out all the way, tilt up the front and remove it. To replace, insert glides at back of drawer beyond stop on range glides. Lift drawer if necessary to insert easily. Let front of drawer down, then push in to close.

## Removable Oven Door

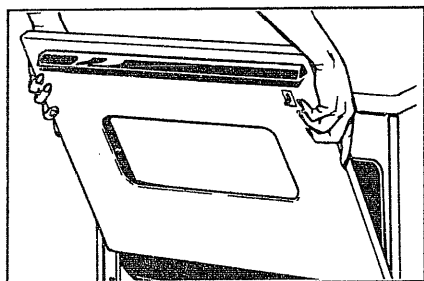

To REMOVE door, open to BROIL position, or where you feel hinge catch slightly. Grasp door at sides; lift door up and away from hinges.

To REPLACE, grasp door at sides, line up door with hinges and push door firmly into place.

## Oven Vent Duct

Your range is vented through a duct located under the right rear Calrod® unit. Clean the duct often.

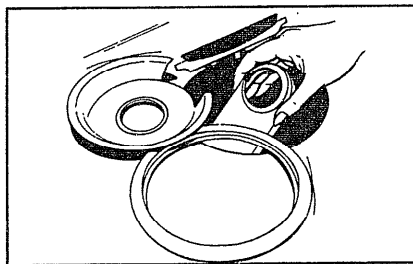

### To remove:

- Make sure unit is cool.
- Lift up right rear surface unit.
- Remove trim ring and drip pan.
- Lift out oven vent duct.

### To replace:

• Place the part over the oven vent located below the cooktop with the opening of the duct under the round opening in the drip pan. It is important that the duct is in the correct position so moisture and vapors from the oven can be released during oven use. **NOTE:** Never cover the hole in the oven vent duct with aluminum foil or any other material. This prevents the oven vent from working properly during any cooking cycle.

## Lamp Replacement

**CAUTION: BEFORE REPLACING ANY LAMP, DISCONNECT ELECTRIC POWER TO RANGE AT THE MAIN FUSE OR CIRCUIT BREAKER PANEL. LET LAMP (OR BULB) AND LAMP COVER COOL COMPLETELY.**

After replacing lamp (bulb), reconnect electrical power to the range.

## Oven Lamp

Remove the oven door, if desired, to reach lamp easily.

If the oven lamp (bulb) has a removable glass cover which is held in place with a bail-shaped wire...

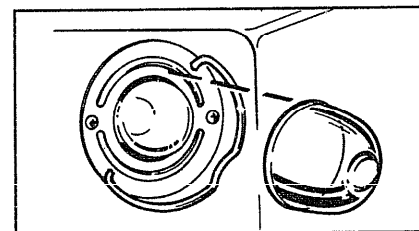

### To remove:

- Hold hand under cover so it doesn't fall when released. With fingers of same hand, firmly push down wire bail until it clears cover. Lift off cover, **DO NOT REMOVE ANY SCREWS TO REMOVE THIS TYPE OF COVER.**
- Replace bulb with a 40-watt home appliance bulb.

### To replace cover:

- Place cover into groove of lamp receptacle. Lift wire bail up to center of cover until it snaps into place. When in place, wire holds cover firmly, but be certain wire bail is not below depression in center of cover.

If lamp cover is held in place with three slotted screws...

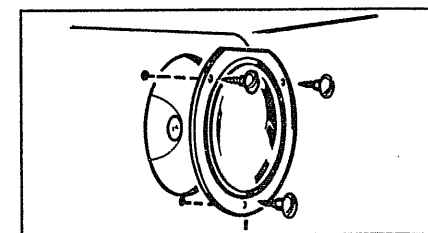

- Remove the screws, remove cover, and replace bulb with 40-watt appliance bulb.
- Replace lamp cover with three screws.

## Cooktop Surface Lamp (Model JB490)

WHEN CHANGING A COOKTOP LAMP, DO NOT TOUCH THE METAL AT ENDS OF LAMP.

Your cooktop light is easily replaced with a fluorescent tube of the same wattage. Make sure the power to the range is disconnected at main fuse or circuit breaker panel or pull plug.

### To remove:

- Lift lamp cover.
- Place fingers on top near each end of light bulb.
- Press down and roll top of bulb gently toward front of range until it stops.
- Remove bulb gently from unit making sure it doesn't hit lamp cover.

### To replace:

- Place fingers on top near each end of light bulb.
- Press bulb gently into slots and roll top of bulb gently toward back of range until it stops.
- Move lamp cover down.

## Surface Units

Clean the area under the drip pans often. Built-up soil, especially grease, may catch fire. To make cleaning easier, tilt-lock units lift up and lock in the up position, and plug-in units are removable.

**Caution:** Be sure all controls are turned to OFF and surface units are cool before attempting to lift or remove them.

After lifting the tilt-lock units or removing plug-in units, remove the trim rings and drip pans under the units and clean them according to directions in the Cleaning Guide on page 25. Wipe around the edges of the surface unit openings. Clean the area below the units. Rinse all washed areas with a damp cloth or sponge.

## Tilt-Lock (stand-up) Units (on models so equipped)

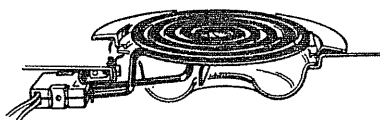

Tilt-Lock units cannot be removed.

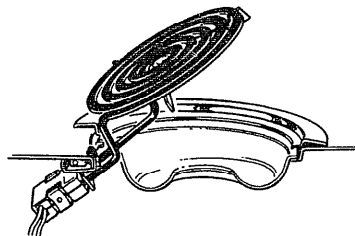

You can lift a tilt-lock unit upward about 6" and it will lock in the up position.

### To reposition the tilt-lock unit:

- Replace the drip pan and trim ring into the recess in the cooktop.
- Put the trim ring in place over the drip pan. The drip pan must be under the trim ring.
- Guide the surface unit into place so it fits evenly into the trim ring.

## Plug-In Units (on models so equipped)

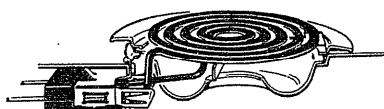

Plug-in units can be removed.

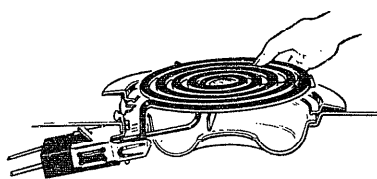

Lift a plug-in unit about 1" above the trim ring—just enough to grasp it—and you can pull it out.

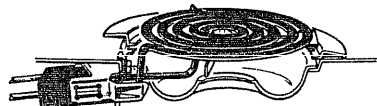

Do not lift a plug-in unit more than 1". If you do, it may not lie flat on the trim ring when you plug it back in.

Repeated lifting of the plug-in unit more than 1" above the trim ring can permanently damage the receptacle.

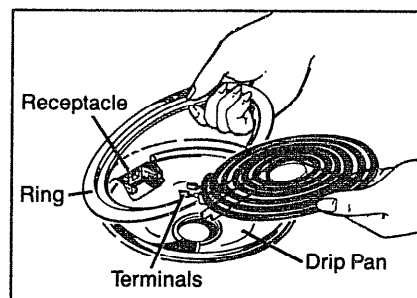

### To replace a plug-in unit:

- First place the drip pan, then the trim ring into the surface unit cavity found on top of the cooktop so the unit receptacle can be seen through the opening in the pan.
- Insert the terminals of the plug-in unit through the opening in the drip pan and into the receptacle.

- Guide the surface unit into place so it fits evenly into the trim ring.

Note: The drip pan must be under the trim ring.

### CAUTION

- Do not attempt to clean plug-in surface units in an automatic dishwasher.
- Do not immerse plug-in surface units in liquids of any kind.
- Do not bend the plug-in surface unit plug terminals.
- Do not attempt to clean, adjust or in any way repair the plug-in receptacle.

(continued next page)



## Care and Cleaning (continued)

### Adjusting Oven Thermostat

Use time given on recipe when cooking first time. Oven thermostats may "drift" from the factory setting over the years and 5- to 10-minute differences in timing between an old and a new oven are not unusual. Your oven has been set correctly at the factory and is more apt to be accurate than the oven which it replaced. However, if you find that your foods consistently brown too little or too much, you may make a simple adjustment in the thermostat (Oven Temp) knob.

**PULL KNOB OFF OF SHAFT, LOOK AT BACK OF KNOB AND NOTE CURRENT SETTING BEFORE MAKING ANY ADJUSTMENT.**

To increase temperature, turn toward HI or RAISE; to decrease turn toward LO or LOWER. Each notch changes temperature 10 degrees.

Follow one of the sketches at right to adjust your oven thermostat.

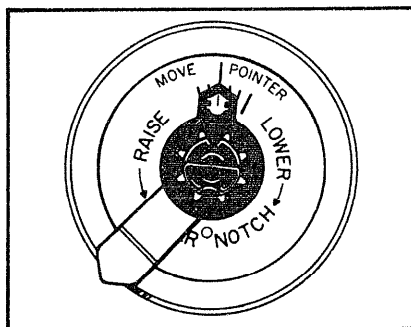

1. Remove knob, and hold it so pointer is at top of knob. Using a pot holder or similar material, hold "skirt" of knob firmly in one hand. Grasp handle of knob in other hand. Note position of pointer and turn handle to move pointer toward Raise or Lower.

Pointer is designed not to move easily. If it is seated so it is difficult to move, pointer may be loosened slightly. Insert a thin screwdriver, knife blade or similar instrument and lift up end of pointer slightly.

2. After adjustment is made, press pointer firmly against knob. Return knob to range, matching flat area on knob and shaft.

Recheck oven performance before making an additional adjustment.

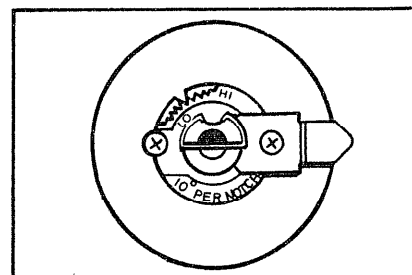

1. Pull off knob, loosen both screws on back of knob.

2. Move pointer one notch in desired direction. Tighten screws.

3. Return knob to range, matching flat area of knob to shaft.

Recheck oven performance before making an additional adjustment.

# Cleaning Guide

Note: Let oven/range parts cool before touching or handling.

PART	MATERIALS TO USE	GENERAL DIRECTIONS
Bake Unit and Broil Unit		Do not clean the bake unit or broil unit. Any soil will burn off when the unit is heated. NOTE: Bake unit is hinged and can be lifted gently to clean oven floor. If spillover, residue or ash accumulates around bake unit, gently wipe around unit with warm water.
Broiler Pan and Rack	<ul style="list-style-type: none"> <li>• Soap and Water</li> <li>• Soap-Filled Scouring Pad</li> <li>• Plastic Scouring Pad</li> </ul>	Drain fat, cool pan and rack slightly. (Do not let soiled pan and rack stand in oven to cool.) Sprinkle on detergent. Fill pan with warm water and spread cloth or paper towel over rack. Let pan and rack stand for a few minutes. Wash; scour if necessary. Rinse and dry. OPTION: Clean pan and rack in dishwasher.
Control Knobs: Range Top and Oven	<ul style="list-style-type: none"> <li>• Mild Soap and Water</li> </ul>	Pull off knobs. Wash gently but do not soak. Dry and return controls to range, making sure to match flat area on knob and shaft.
Outside Glass Finish	<ul style="list-style-type: none"> <li>• Soap and Water</li> </ul>	Clean outside of cooled black glass door with a glass cleaner that does not contain ammonia. Wash other glass with cloth dampened in soapy water. Rinse and polish with a dry cloth. If knobs are removed, do not allow water to run down inside surface of glass while cleaning.
Metal, including Brushed Chrome and Cooktop	<ul style="list-style-type: none"> <li>• Soap and Water</li> </ul>	Wash, rinse, and then polish with a dry cloth. DO NOT USE steel wool, abrasives, ammonia, acids, or commercial oven cleaners which may damage the finish.
Porcelain Enamel Surface*	<ul style="list-style-type: none"> <li>• Paper Towel</li> <li>• Dry Cloth</li> <li>• Soap and Water</li> </ul>	Avoid cleaning powders or harsh abrasives which may scratch the enamel. If acids should spill on the range while it is hot, use a dry paper towel or cloth to wipe up right away. When the surface has cooled, wash and rinse. For other spills, such as fat splatterings, etc., wash with soap and water when cooled and then rinse. Polish with a dry cloth.
Painted Surfaces	<ul style="list-style-type: none"> <li>• Soap and Water</li> </ul>	Use a mild solution of soap and water. Do not use any harsh abrasives or cleaning powders which may scratch or mar surface.
Inside Oven Door*	<ul style="list-style-type: none"> <li>• Soap and Water</li> </ul>	Remove oven door by opening it to BROIL position, grasping it at sides, and lifting up and away from hinges. Clean with soap and water. Replace by grasping door at sides, lining up door with hinges, and pushing door firmly into place.
Oven Gasket*		Avoid getting ANY cleaning materials on the gasket.
Oven Liner	<ul style="list-style-type: none"> <li>• Soap and Water</li> </ul>	Cool before cleaning. Frequent wiping with mild soap and water will prolong the time between major cleanings. Be sure to rinse thoroughly.
Oven Vent Duct	<ul style="list-style-type: none"> <li>• Soap and Water</li> </ul>	Remove the Oven Vent Duct found under the right rear surface unit. Wash in hot, soapy water, dry and replace. (Opening should match opening in drip pan.)
Shelves (See Self-Cleaning Oven Directions)	<ul style="list-style-type: none"> <li>• Soap and Water</li> </ul>	Shelves can be cleaned in Self-Cleaning oven or dishwasher, or by hand, using soap and water. Rinse thoroughly to remove soap after cleaning.
Calrod® Surface Unit Coils		Spatters and spills burn away when coils are heated. After meal, remove all cookware from surface units and heat soiled units at HI. Let soil burn off about a minute and switch units to OFF. Try not to get cleaning materials on coils. If you do, wipe off with damp paper towel <i>before</i> heating surface unit. DO NOT handle the unit before completely cooled. DO NOT attempt to clean the plug-in units in the self-cleaning oven. DO NOT immerse plug-in units in any kind of liquid.
Chrome-Plated Trim Rings	<ul style="list-style-type: none"> <li>• Soap and Water</li> <li>• Stiff-Bristled Brush</li> <li>• Soap-Filled Scouring Pad (Non-metallic)</li> </ul>	Clean as described below or in dishwasher. DO NOT CLEAN IN SELF-CLEANING OVEN. Rings will discolor. Wipe after each cooking so unnoticed spatter will not "burn on" next time you cook. To remove "burned-on" spatters, use any or all cleaning materials mentioned. Rub <i>lightly</i> with scouring pad to prevent scratching of the surface.
Porcelain Enamel or Aluminum Drip Pans	<ul style="list-style-type: none"> <li>• Soap and Water</li> <li>• Soap-Filled Scouring Pad</li> <li>• Plastic Scouring Pad</li> </ul>	Drip pans can be cleaned in self-cleaning oven or dishwasher or by hand—after pans cool slightly, sprinkle on detergent, wash or scour with hot water, rinse and dry.

\*Spillage of marinades, fruit juices, and basting materials containing acids may cause discoloration. Spillovers should be wiped up immediately, with care being taken to not touch any hot portion of the oven. When the surface is cool, clean and rinse.



## Questions? Use This Problem Solver

PROBLEM	POSSIBLE CAUSE AND REMEDY
OVEN WILL NOT WORK	Plug on range is not completely inserted in the electrical outlet. The circuit breaker in your house has been tripped, or a fuse has been blown. Oven controls not properly set. Door left in locked position after cleaning.
OVEN LIGHT DOES NOT WORK	Light bulb is loose. Bulb is defective. Replace. Switch operating oven light is broken. Call for service.
FOOD DOES NOT BROIL PROPERLY	OVEN SET knob not set at BROIL. OVEN TEMP knob not set at BROIL. Door not left ajar as recommended. Improper shelf position being used. Check Broiling Guide. Necessary preheating was not done. Food is being cooked on hot pan. Utensils are not suited for broiling. Aluminum foil used on the broil pan rack has not been fitted properly and slit as recommended.
FOOD DOES NOT ROAST OR BAKE PROPERLY	OVEN SET knob not set on BAKE. OVEN TEMP knob not set correctly. Shelf position is incorrect. Check Roasting or Baking Guides. Oven shelf is not level. Incorrect cookware or cookware of improper size is being used. A foil tent was not used when needed to slow down browning during roasting.
CALROD® SURFACE UNITS NOT FUNCTIONING PROPERLY	Surface units are not plugged in solidly. Trim rings and drip pans are not set securely in the range top. Surface unit controls are not properly set.
OVEN WILL NOT SELF-CLEAN	Automatic timer dials not set or not set properly. Clock must be set to time of day and the STOP dial must be set and advanced beyond the time noted on oven clock. The STOP dial was not advanced for long enough. Both OVEN SET and OVEN TEMP knobs must be set at CLEAN setting. A thick pile of spillover when cleaned leaves a heavy layer of ash in spots which could have insulated the area from further heat. Latch not moved to the right.
OVEN DOOR WON'T LATCH	Turn OVEN SET knob to CLEAN. Glowing Locked Light after knob is turned indicates oven is too hot from previous use and door won't latch. To cool oven, open door wide, then Latch can be moved. OVEN SET knob must be at CLEAN or OFF before Latch can be moved.

If you need more help...call, toll free:  
GE Answer Center®  
800.626.2000  
consumer information service

## If You Need Service

To obtain service, see your warranty on the back page of this book.

We're proud of our service and want you to be pleased. If for some reason you are not happy with the service you receive, here are three steps to follow for further help.

**FIRST**, contact the people who serviced your appliance. Explain why you are not pleased. In most cases, this will solve the problem.

**NEXT**, if you are still not pleased, write all the details—including your phone number—to:

Manager, Consumer Relations  
GE Appliances  
Appliance Park  
Louisville, Kentucky 40225

**FINALLY**, if your problem is still not resolved, write:

Major Appliance  
Consumer Action Panel  
20 North Wacker Drive  
Chicago, Illinois 60606

# YOUR GENERAL ELECTRIC RANGE WARRANTY

Save proof of original purchase date such as your sales slip or cancelled check to establish warranty period.

## WHAT IS COVERED

### FULL ONE-YEAR WARRANTY

For one year from date of original purchase, we will provide, free of charge, parts and service labor in your home to repair or replace **any part of the range** that fails because of a manufacturing defect.

This warranty is extended to the original purchaser and any succeeding owner for products purchased for ordinary home use in the 48 mainland states, Hawaii and Washington, D.C. In Alaska the warranty is the same except that it is **LIMITED** because you must pay to ship the product to the service shop or for the service technician's travel costs to your home.

All warranty service will be provided by our Factory Service Centers or by our authorized Customer Care® servicers during normal working hours.

Look in the White or Yellow Pages of your telephone directory for **GENERAL ELECTRIC COMPANY, GENERAL ELECTRIC FACTORY SERVICE, GENERAL ELECTRIC-HOTPOINT FACTORY SERVICE or GENERAL ELECTRIC CUSTOMER CARE® SERVICE.**

## WHAT IS NOT COVERED

- Service trips to your home to teach you how to use the product.

### Read your Use and Care material.

If you then have any questions about operating the product, please contact your dealer or our Consumer Affairs office at the address below, or call, toll free: GE Answer Center®  
800.626.2000  
consumer information service

- Improper installation.

If you have an installation problem, contact your dealer or installer. You are responsible for providing adequate electrical, gas, exhausting and other connecting facilities.

- Replacement of house fuses or resetting of circuit breakers.

- Failure of the product if it is used for other than its intended purpose or used commercially.

- Damage to product caused by accident, fire, floods or acts of God.

**WARRANTOR IS NOT RESPONSIBLE FOR CONSEQUENTIAL DAMAGES.**

Some states do not allow the exclusion or limitation of incidental or consequential damages, so the above limitation or exclusion may not apply to you. This warranty gives you specific legal rights, and you may also have other rights which vary from state to state. To know what your legal rights are in your state, consult your local or state consumer affairs office or your state's Attorney General.

**Warrantor: General Electric Company**

**If further help is needed concerning this warranty, write:  
Manager—Consumer Affairs, GE Appliances, Louisville, KY 40225**

Part No. 164D1352P152

Pub. No. 49-4943

0-88

JB391GK JSP27J  
JB400GK JSP28GJ  
JB490GJ