

This Owner's Manual is provided and hosted by [Appliance Factory Parts](#).

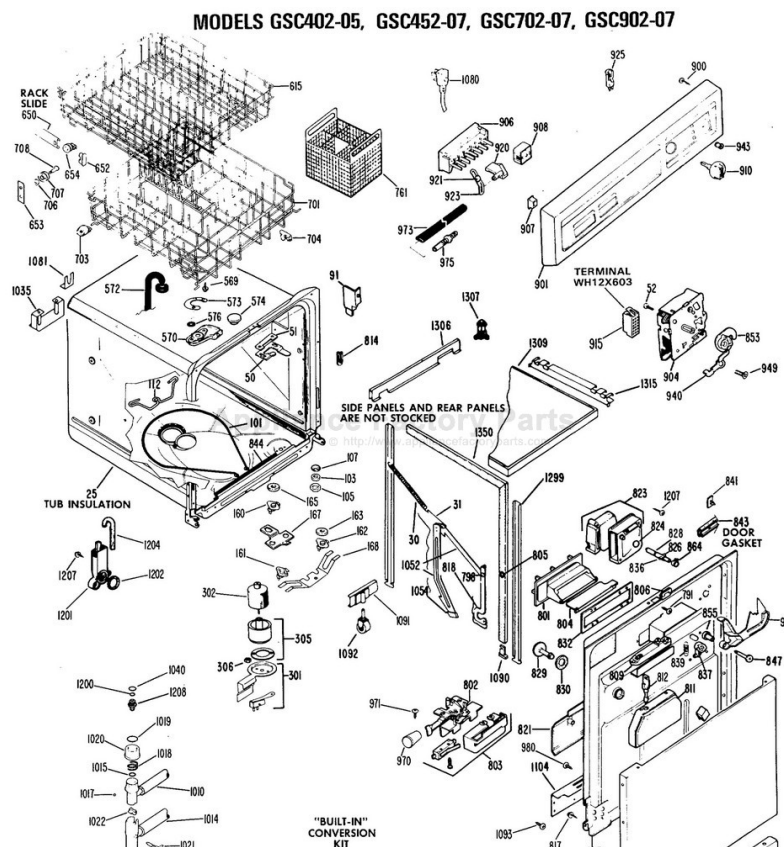

# GE GSC402-05 Owner's Manual

[Shop genuine replacement parts for GE GSC402-05](#)



[Find Your GE Dishwasher Parts - Select From 6722 Models](#)

----- Manual continues below -----



GSC402

PUB# 49-5403

10-11-88

Dishwasher

Contents

Appliance Registration	2	Repair Service	15
Care and Cleaning	15	Rinse Agent	6
China, Crystal, Sterling	10	Safety Instructions	3
Conversion Kit	15	Unicouple	12
Cycle Features	4, 5	User Maintenance Instructions	15
Detergent, Detergent Guide	6, 7	Warranty	Back Cover
Dispenser Cups	7	Water Temperature	6
Electrical Requirements	11	Winter Storage	15
Energy Saver Switch	4, 5		
Energy-Saving Tips	2		
Loading	8, 9		
Model and Serial Numbers	2		
Operating Instructions	4, 5		
Cycle Selection	5		
Drying Options	4, 5	<b>GE Answer Center®</b>	
Problem Solver	13, 14	<b>800.626.2000</b>	

Convertible Model GSC402

GE Appliances

EFFDATE 07-25-88

49-5403

## Help us help you...

### Before using your dishwasher, read this book carefully.

It is intended to help you operate and maintain your new dishwasher properly.

Keep it handy for answers to your questions.

If you don't understand something or need more help, write (include your phone number):

Consumer Affairs  
GE Appliances  
Appliance Park  
Louisville, KY 40225

### If you received a damaged dishwasher...

Immediately contact the dealer (or builder) that sold you the dishwasher.

### Save time and money. Before you call for service...

Check the Problem Solver (pages 13 and 14). It lists causes of minor operating problems that you can correct yourself.

### Write down the model and serial numbers.

You'll find them on a label just inside the dishwasher door.

These numbers are also on the Consumer Product Ownership Registration Card that comes with your dishwasher. Before sending in this card, please write these numbers here:

Model Number \_\_\_\_\_

Serial Number \_\_\_\_\_

Use these numbers in any correspondence or service calls concerning your dishwasher.

To obtain Hispanic version of this book, call  
GE Answer Center®  
800.626.2000  
consumer information service.

Para obtener la versión en español de éste manual, llame a  
GE Answer Center®  
servicio de información para el consumidor,  
teléfono 800.626.2000.

## Energy-saving tips

The power consumption of your dishwasher can be minimized if you follow these suggestions:

- **Operate dishwasher only when full.** Let dishes accumulate in dishwasher. When you put in a partial load, use RINSE ONLY cycle to rinse off heavy soils. Be sure to latch door when waiting for full load. This helps keep soils moist, easier to remove.
- **Select cycle that uses least amount of water to remove soil from load.** See page 4.
- **If you don't need your dishes right away, use your ENERGY-SAVER no-heat feature** that turns the drying heater off automatically. Dishes dry naturally over a longer period such as overnight.

# IMPORTANT SAFETY INSTRUCTIONS

Read all instructions before using this appliance.

**WARNING**—When using this appliance, always exercise basic safety precautions, including the following:

- Use this appliance only for its intended purpose, as you will find described in this Use and Care Book.

- This dishwasher must be properly installed and located in accordance with the Installation Instructions before it is used. If you did not receive an Installation Instructions sheet with your dishwasher, you can obtain one by contacting the service location nearest you. See page 11 for additional instructions.

—Connect to a properly rated, protected and sized power-supply circuit to avoid electrical overload.

—This appliance must be grounded. In the event of a malfunction or breakdown, grounding will reduce the risk of electric shock by providing a path of least resistance for electric current. This appliance is equipped with a cord having an equipment-grounding conductor and a grounding plug. The plug must be plugged into an appropriate outlet that is installed and grounded in accordance with all local codes and ordinances.

**DANGER**—Improper connection of the equipment-grounding conductor can result in a risk of electric shock. Check with a qualified electrician or service technician if you are in doubt as to whether the appliance is properly grounded. Do not modify the plug provided with the appliance; if it will not fit the outlet, have a proper outlet installed by a qualified electrician.

- Use only powder or liquid detergents or wetting agents recommended for use in a dishwasher.

- Do not wash plastic items unless marked “dishwasher safe” or the equivalent. For plastic items not so marked, check the manufacturer’s recommendations.

- Load light plastic items so they will not become dislodged and drop to the bottom of the dishwasher—they might come into contact with the heating unit and be damaged.

**To minimize the possibility of injury.**

- When loading items to be washed:

A. Locate sharp items so that they are not likely to damage the door seal, and

B. Load sharp knives with the handles up to reduce the risk of cut-type injuries.

- Do not touch the heating element during or immediately after use.

- Do not operate your dishwasher unless all enclosure panels are properly in place.

- Do not tamper with controls.

- Do not abuse, sit on, or stand on the door or dish rack of the dishwasher.

- Close supervision is necessary if this appliance is used by or near children. Do not allow children to play inside, on or with this appliance or any discarded appliance. Dispose of

discarded appliances and shipping or packing material properly. Before discarding a dishwasher, remove the door of the washing compartment.

- Keep all washing detergents and wetting agents out of the reach of children, preferably in a locked cabinet. Observe all warnings on container labels to avoid personal injury.

- To prevent dishwasher from tipping over, do not extend both racks when loaded, and do not lean or push down on:

—open door

—upper rack when fully extended.

- **HYDROGEN GAS** is produced by the chemical action within your water heater. It can accumulate in the water heater and/or water pipes if hot water has not been used for a period of two weeks or longer. **HYDROGEN GAS IS EXPLOSIVE.** To prevent the possibility of damage or injury, if you have not used hot water for two weeks or more, or move into a residence in which the hot water system may not have been used for some time, turn on all hot water faucets and allow them to run for several minutes before using any electrical appliance which is connected to the hot water system. This will allow any hydrogen gas to escape. Also, since the gas is flammable, do not smoke or use an open flame or appliance during this process.

**SAVE THESE INSTRUCTIONS**

IMPORTANT SAFETY INSTRUCTIONS

IMPORTANT SAFETY INSTRUCTIONS

# How to operate your dishwasher

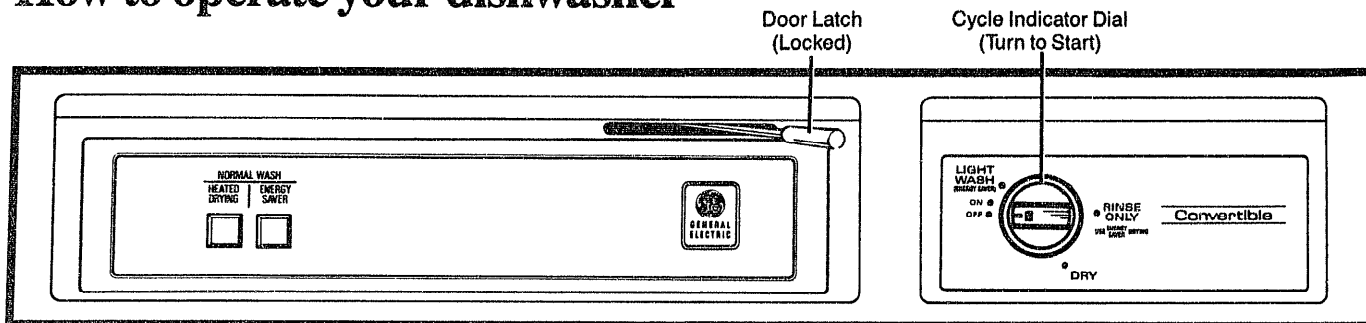

Before using your dishwasher the first time, install the Faucet Adapter according to instructions on page 12. This is a one-time only chore.

**STEP 1.** Load your dishwasher with dishes, silverware, pots, pans, bowls, etc. according to instructions on pages 8 and 9.

**STEP 2.** Add detergent to the detergent dispenser. Make sure the Cycle Indicator Dial is at OFF position before adding detergent. See pages 6 and 7.

Use rinse aid agent to help prevent spotting. See page 6.

Connect Unicouple and electricity according to instructions on pages 11 and 12.

**STEP 3.** Select Drying Heat Option.

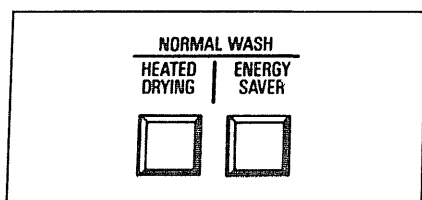

**HEATED DRYING.** Turns the drying heater on for fast drying.

**ENERGY SAVER (no-heat drying).** Turns the drying heater off to save energy. Dishes dry naturally over a longer period such as overnight.

If you need your dishes sooner, open the dishwasher door after the cycle is complete to reduce the natural drying time.

Use of this option reduces the electrical energy used by this model approximately 9% for Normal cycle.

**STEP 4.** Select the Cycle and start dishwasher.

If your dishwasher drains into a food waste disposer, operate the disposer until it is empty before starting the dishwasher. (See Cycle selection hints on next page.)

To obtain the benefits of a complete cycle, be careful that you **do not turn the dial any further than necessary** to start the dishwasher.

• **For NORMAL WASH cycle:**

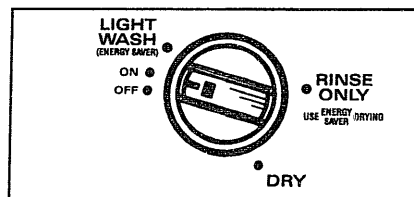

- Latch the door.
- Slowly turn Cycle Indicator Dial to ON position to start the cycle.

• **For LIGHT WASH cycle:**

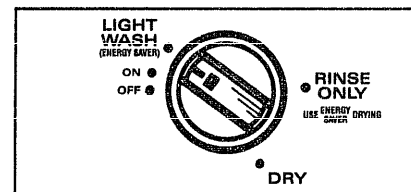

- Be sure door is unlatched.
- Slowly turn Cycle Indicator Dial to LIGHT WASH position.
- Latch door to start the cycle.

• **For RINSE ONLY cycle:**

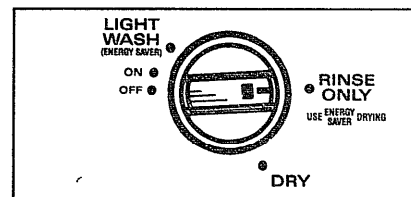

- Be sure door is unlatched.
- Select ENERGY SAVER drying option.
- Slowly turn Cycle Indicator Dial to RINSE ONLY position.
- Latch the door to start the cycle.

## Cycle Selection Hints

### NORMAL WASH—

For most loads of everyday dishes, glasses and cookware.

### LIGHT WASH—

For dishes that have been *pre-rinsed* before loading. Also, for washing *very lightly* soiled dishes with soils that have not dried on.

### RINSE ONLY—

For rinsing partial loads which will be washed later. *Do not use detergent.*

## What Happens in Each Cycle

- You'll hear occasional clicking sounds:
  - Soft food disposer shredding action.
  - Drain valve opening to pump water out.
  - Timer control as cycle progresses.
  - Detergent cup opening.
- During the drying period:
  - The motor stops during drying.
  - Water vapor comes through the vent under the door latch during drying and when water is being circulated.

Wash Cycles	Water Use Gallons (approx.)	Wash Cycle Time (approx. minutes)	Cycle Sequence					
			Wash/Rinse	Rinse	Main Wash	Rinse	Rinse	Rinse
NORMAL WASH	10.7	56*	Wash/Rinse	Rinse	Main Wash	Rinse	Rinse	Rinse
LIGHT WASH	8.9	51	Wash/Rinse	Main Wash	Rinse	Rinse	Rinse	
RINSE ONLY	5.1	15			Rinse	Rinse	Rinse	

\*HEAT DRYING. Add 28 minutes.

ENERGY SAVER. Calrod Heater is turned off. Dishes dry naturally.

## Good dishwashing starts with **HOT** water.

To get dishes clean and dry, you need hot water. To help you get water of the proper temperature, your dishwasher automatically heats the water in the wash cycle. For good washing and drying, the entering water must be at least 120°F. To prevent dish damage, inlet water should not exceed 150°F.

### How to test water temperature:

Check the water temperature inside your dishwasher with a candy or meat thermometer.

Let the dishwasher run through one fill and pump out cycle, then let the dishwasher fill with water the second time.

When you hear the water stop filling, unlatch the door and slowly open it.

Measure the temperature of the water in the bottom of the tub this way:

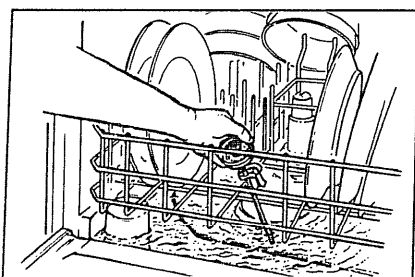

Remove the silverware basket and place a candy or meat thermometer in the water towards the middle of the tub. If the temperature is less than 120°F, you will not get good washing results. Higher water temperature is needed to dissolve grease and activate powder detergents.

**Helpful hints:** If outside temperatures are unusually low, or if your water travels a long distance from water heater to dishwasher, you may need to set your water heater's thermostat up. If you have not used hot water for some time, the water in the pipes will be cold. Turn on the hot water faucet at the sink and allow it to run until the water is hot. Then start the dishwasher. If you've recently done laundry or run hot water for

showers, give your water heater time to recover before operating the dishwasher.

To improve washability if the water is less than 120°F and you cannot adjust your water heater: Select a longer cycle and fill both detergent cups at least half-full with detergent.

## Help prevent spotting with a rinse agent.

A rinse agent makes water flow off dishes quicker than usual. This lessens water spotting and makes drying faster, too.

For best dishwashing performance, use of a rinse agent such as JET-DRY brand is recommended.

Rinse agents come in either liquid or solid form. Your dishwasher uses the solid form.

**If you can't find any rinse agent,** write:

BENCKISER CONSUMER PRODUCTS, INC.

("JET DRY")

1210 W County Road E.

Arden Hills, MN 55112

## How to choose and use the right detergent.

**First, use only powder or liquid detergent specifically made for use in dishwashers. Other types will cause oversudsing.**

**Second, check the phosphate content.** Phosphate helps prevent hard-water materials from forming spots or film on your dishes. If your water is hard (7 grains or more), your detergent has to work harder. Detergents with a higher phosphate level will probably work better. If the phosphate content is low (8.7% or less), you'll have to use extra detergent with hard water.

**Your water department can tell you how hard your water is.** So can your county extension agent. Or your area's water softener company. Just call and ask them how many "grains" of hardness is in your water.

**How much detergent should you use?** That depends. Is your water "hard" or "soft"? With hard water, you need extra detergent to get dishes clean. With soft water, you need less detergent.

Too much detergent with soft water not only wastes money, it can be harmful. It can cause a permanent cloudiness of glassware, called "etching." An outside layer of glass is etched away! But why take a chance when it's easy to find out the hardness of your water.

**Keep your detergent fresh and dry.** Under the sink isn't a good place to store detergent. Too much moisture. Don't put powder detergent into the dispenser until you're ready to wash dishes, either. (It won't be fresh OR dry.)

**If your powder detergent gets old or lumpy, throw it away.** It won't wash well. Old detergent often won't dissolve.

If you use a liquid dishwasher detergent, these precautions are not necessary because liquid detergents don't "lump" as they age or come in contact with water.

You'll find two detergent dispensers on the inside door of your dishwasher. Two, because some cycles use two washes.

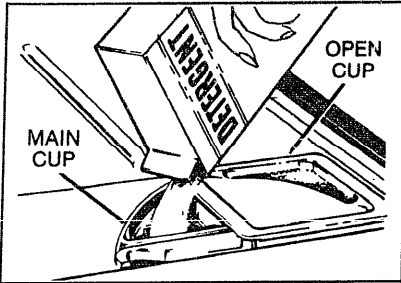

See "Detergent Usage Guide" below. (Be sure the Cycle Indicator Dial is at OFF position before adding detergent. Otherwise, the detergent cup will not close and latch properly.)

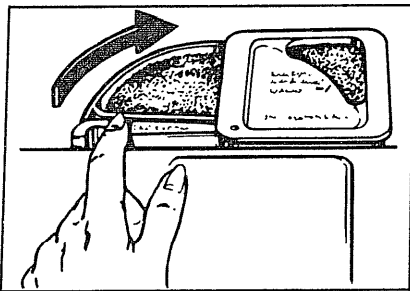

Close the main cup.  
NOTE: Detergent cup may be opened manually with no harm.

## How to prepare the dishes for washing.

If this is your first dishwasher, or if you're replacing a much older model, you may wonder how much pre-preparation your dishes need. Actually very little. Pre-rinsing of normal food soils is not necessary. With common sense and a little practice you'll soon know what foods to remove. Here are some guidelines:

1. Scrape off bones, seeds, skins, toothpicks and other hard solids. It is also best to remove hard shelled vegetables, meat trimmings, leafy vegetables and crusts. Remove excessive quantities of oil or grease.
2. Remove large quantities of any food. Your dishwasher has a built-in soft food disposer that pulverizes soft food bits and flushes them away. It can handle *small* amounts of soft foods, but large amounts will be difficult to handle.

3. Try to remove food scraps and place dishes in dishwasher before soil has a chance to dry and become hard. Dishes with dried-on soil are more difficult to wash and may require additional preparation for good results. Remember to use your RINSE ONLY cycle for small "holding" loads.

**Note:** The foods mentioned above are for examples only. Other foods not mentioned may also need to be removed from your dishes. You may also want to consider removing foods such as mustard, mayonnaise, vinegar, lemon juice and other foods that can cause discoloration of stainless steel if allowed to remain on dishes for a long period of time.

## Detergent Usage Guide (powder or liquid)

CYCLES	SOFT WATER (0-3 grains hardness)		MEDIUM WATER (3-7 grains)		HARD WATER (7-12 grains*)	
	Main Cup	Open Cup	Main Cup	Open Cup	Main Cup‡	Open Cup‡
NORMAL WASH cycle	1 Tablespoon minimum	1 Tablespoon minimum	Half Full	Half Full	Completely Full	Completely Full
LIGHT WASH cycle	1 Tablespoon minimum	None	Half Full	None	Completely Full	None
RINSE ONLY cycle	Use no detergent		Use no detergent		Use no detergent	

\*12 grains and up is extremely hard water. A water softener is recommended. Without it, lime can build up in the water valve. The water valve may stick while open and cause flooding.

‡Filled Main Cup holds 3 tablespoons; Filled Open Cup holds 2 tablespoons.



## How to load your dishwasher

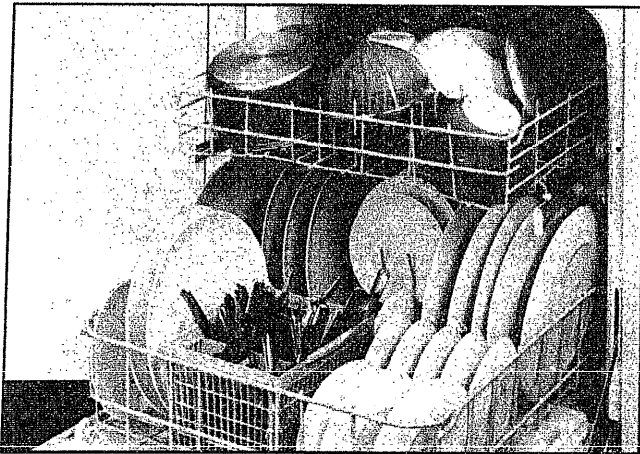

*This is a random mixed load, the most common type you will have.*

Make sure dishes are properly loaded to insure that water can reach the soiled surfaces. The wash arm in the bottom sprays water up. The tower that rises in the center sends water out over the dishes to wash the items in the upper rack.

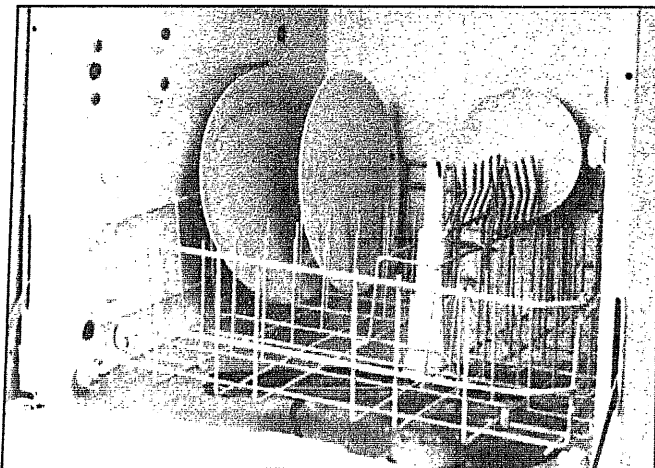

### **WATCH OUT FOR THIS.**

The wash tower rises through the center of the bottom rack during the wash and rinse portions of the cycle. Don't block it or load tall things next to it. Also, be careful not to let portions of items such as knives, skewers or pot handles extend through the bottom rack or the silverware basket.

## How to load the TOP RACK

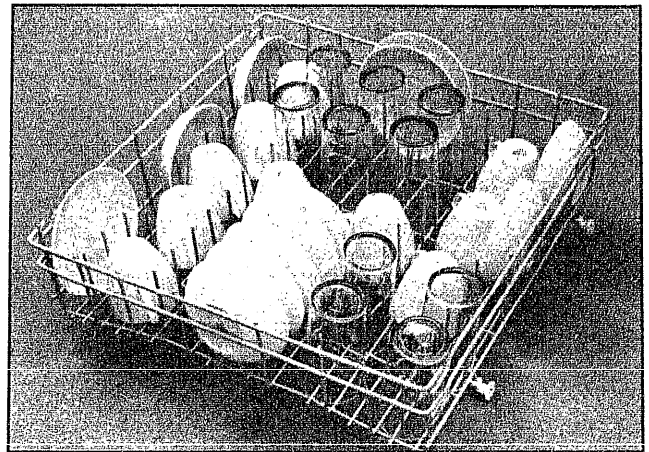

The top rack is best for glasses, cups and saucers. Cups and glasses fit best along the sides. This is the place for dishwasher-safe plastics, too. Make sure small plastic items are lodged in tightly so they can't fall onto the Calrod® heating unit.

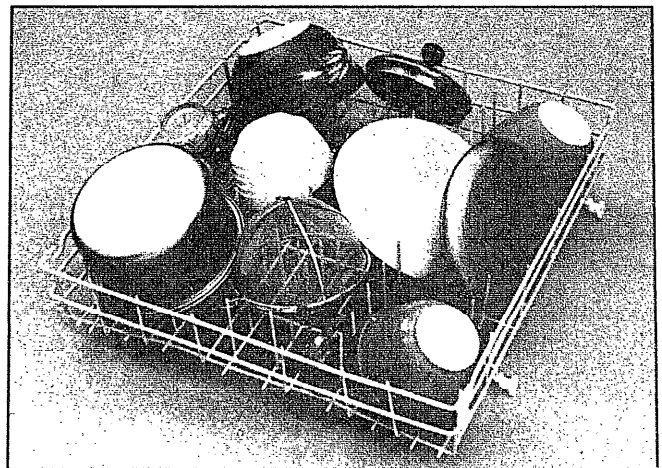

Sauce pans, mixing bowls and other small items may be placed—face down—in the top rack. The top rack is handy for all kinds of odd shapes. Be sure the force of water and detergent can reach soiled surfaces.

## How to load the BOTTOM RACK

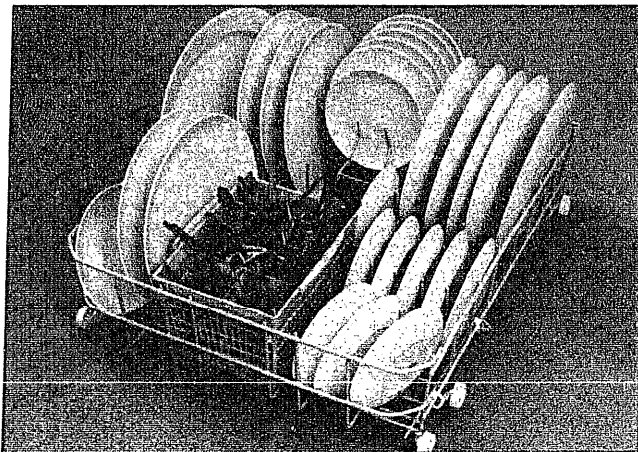

Fit plates and saucers between the pins. Load platters, pots and bowls along the sides, in corners or in the back.

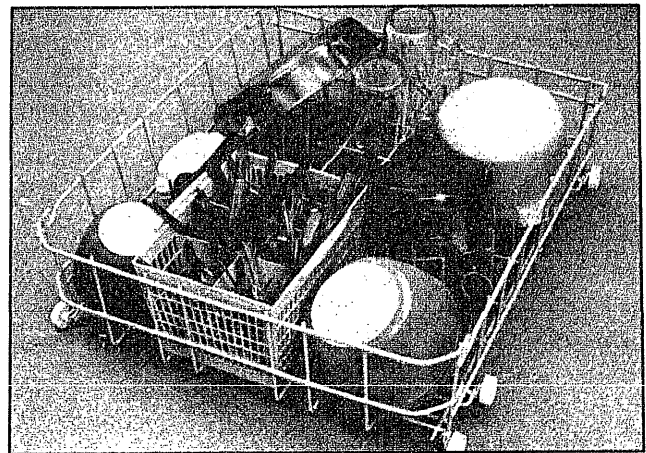

Heavily soiled pots, pans and casseroles **MUST** be loaded in the bottom rack, facing down. Prop broiler pans and racks along the edge. Shallow items may be angled provided the lower side does not shield the soiled surface inside from the water.



Put flatware in the removable silverware basket with handles up to protect your hands. Mix knives, forks and spoons so they don't nest together. Distribute evenly. Small plastic items, such as measuring spoons and lids from small containers, are not recommended for automatic dishwashing. If placed in the dishwasher, they should go in the bottom of the silverware basket with the silverware on top.

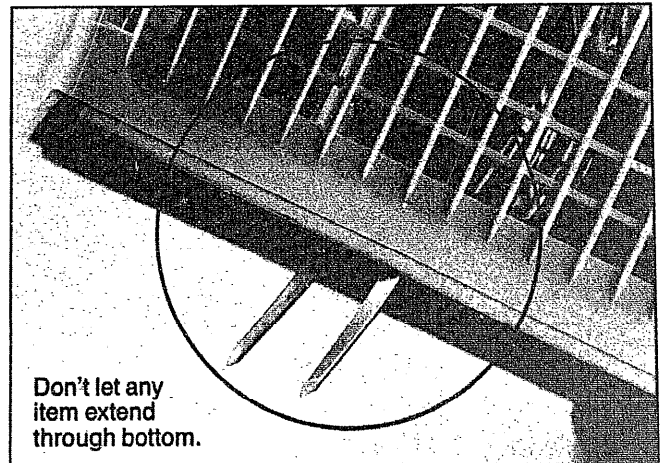

Take out anything that might fall or extend through the bottom of the silverware basket.

## What you can usually wash safely in your dishwasher. And what you can't.

Material	Usually Safe	Exceptions (not safe)	Special Instructions
Aluminum	YES	Some colored anodized aluminum can fade.	Some darkening or spotting possible. Remove by scouring with soap-filled steel wool pads.
China/ Stoneware	YES	Antique, metal-trimmed, hand-painted or over-the-glaze patterns fade. Gold leaf will discolor.	If in doubt, check with the manufacturer. Or test wash one piece daily for at least a month. Compare with the rest of the set.
Crystal	YES	Antique, metal-trimmed or hand-painted patterns fade. Gold leaf will discolor.	Load securely to prevent movement. Check manufacturer's instructions for your crystal.
Non-dishware items—such as electronic air cleaner filters, furnace filters, paint brushes, etc.	NO		Do not wash in dishwasher. Damage to dishwasher and discoloration or staining of dishwasher may result.
Glass	YES	Milk Glass may yellow.	
Iron	NO	Iron will rust.	
Pewter	NO	Pewter tarnishes.	
Plastics	YES		If it doesn't say <b>DISHWASHER SAFE</b> , test one piece before dishwashing an entire set. Wash in top rack only.
Stainless steel	YES		Rinse if not washing immediately. Salty or acid foods can stain if left on.
Sterling Silver and Silver plate	YES	Don't put in same silverware basket with stainless steel. Contact between metals can damage silver. Don't use copper utensils in the same load. Silver may get a brown film. Adhesive used to attach some hollow-handle knives can loosen.	Rinse if not washing immediately. Salty or acid foods can stain if left on. Dry detergent can cause difficult-to-remove black spots. Place in back section of silverware basket to avoid exposure to detergent from the detergent cup.
Non-stick coatings	YES		After washing, wipe the non-stick coating area with vegetable oil to keep it from losing its non-stick quality.
Tin	NO	Tin can rust.	
Wood	NO	Wood can warp, crack or lose its finish with any type washing.	

### Forget a dish? Here's when you can add it.

Add dishes any time during the **RINSE ONLY** cycle. With other wash cycles, you can add dishes at any time **BEFORE** the main detergent wash portion of the cycle.

However, opening the door during any cycle lessens cleaning power. So try to load everything at the beginning.

Here's how to add a forgotten dish:

1. Push the door latch to the left. Washing will stop.

2. Wait a few seconds until the water calms. Then open the door.  
3. Add dishes you've forgotten.  
4. Close the door and push the latch to the far right. When the door is locked, washing will continue.

# How to connect electricity

## IMPORTANT—PLEASE READ CAREFULLY

### Caution, for personal safety:

**DO NOT USE AN EXTENSION CORD OR AN ADAPTER PLUG WITH THIS APPLIANCE.**

**DO NOT, UNDER ANY CIRCUMSTANCES, CUT OR REMOVE THE THIRD GROUNDING PRONG FROM THE POWER CORD.**

**Dishwasher must be electrically grounded in accordance with local codes and ordinances, or in the absence of local codes, in accordance with the NATIONAL ELECTRICAL CODE, ANSI/NFPA NO. 70-1987.**

### Electrical requirements

- This appliance must be supplied with 120V, 60Hz, and connected to an individual, properly grounded branch circuit, protected by a 15 or 20 amp circuit breaker or time-delay fuse.

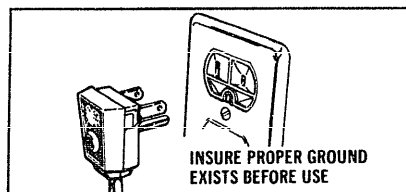

- If the electric supply provided does not meet the above specifications, it is recommended that a licensed electrician install an approved outlet.

- Your dishwasher circuit should not be used for any other appliance while the dishwasher is in operation as the dishwasher requires the full capacity of the circuit.

- If the wall receptacle you plug the dishwasher's power cord into is controlled by a switch, turn on the switch.

# How to use the Unicouple

## Before operating your dishwasher the first time...

**Attach the Aerator Faucet Adapter.** The special aerator faucet adapter supplied with your dishwasher must be assembled to the sink faucet before you can use your dishwasher.

The faucet adapter is designed to fit standard spouts having internal or external threads. You will find the adapter and two washers in the "Hardware for Installation" packet in your dishwasher.

**To install faucet adapter,** first remove the old aerator or trim ring on your faucet spout.

**If faucet has external threads:**

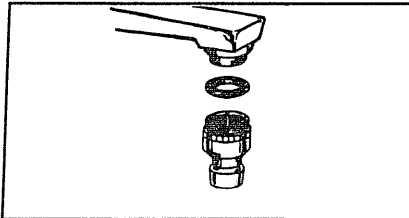

Insert the thinner of the two washers into the faucet adapter and attach it to the faucet spout.

**If faucet has internal threads:**

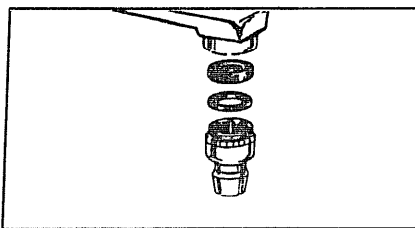

Insert both washers into the faucet adapter and attach it to the faucet spout.

**If the faucet adapter threads do not match your faucet spout,** your local hardware or plumbing supply store normally has additional fittings to adapt your faucet spout to the special aerator faucet adapter.

*NOTE: A sink spray attachment hose can burst if it is installed on the same sink with your dishwasher. We suggest that you disconnect the sink spray attachment if your sink has one and plug the hole.*

## How to connect the Unicouple

1. Pull Unicouple and its hoses from storage compartment located at rear of dishwasher and attach it to the faucet adapter.

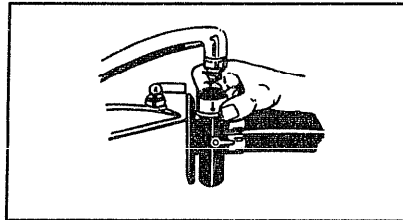

2. Attach the Unicouple connector to the faucet adapter by depressing collar at the top of the connector. When Unicouple is all the way up onto the adapter, release the collar. It will then snap into position to lock the Unicouple in place.

The Unicouple's small hose carries water from the faucet to the dishwasher. Its large hose carries drain water to the sink. Be sure drain hose is pointing toward the sink bowl drain opening and the sink drain is open for water that will drain from your dishwasher. If your dishwasher drains into a disposer, operate the disposer until it is completely empty before starting the dishwasher.

3. Turn hot water fully on before starting the dishwasher.

## How to use the Faucet-Flo nozzle

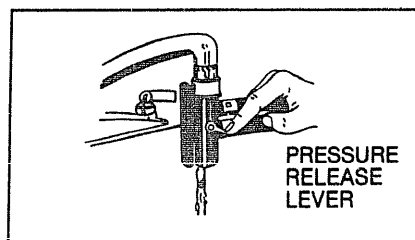

The Faucet-Flo nozzle is part of the Unicouple connector. Operate the nozzle by depressing the pressure release lever on the side of the Unicouple connector. You will find the Faucet-Flo nozzle useful for several reasons. For example:

- It allows you to flush cold water out of the hot water line so that you can better regulate your water temperature.
- It allows you to test the temperature of the water before starting your dishwasher.

**If you need fresh water for personal use:**

Disconnect the Unicouple.

Draw your fresh water directly from your faucet.

Do not disconnect the Unicouple while the dishwasher is operating.

## How to disconnect the Unicouple from faucet adapter

1. Turn off the hot water.
2. Release the water pressure by depressing the pressure release lever. This relieves water pressure and protects you, and the room, from severe splashing.
3. Release Unicouple from faucet by depressing the collar at the top of the Unicouple connector.

## How to disconnect your dishwasher

1. Remove the power cord plug from the wall receptacle.
2. Disconnect Unicouple from faucet adapter.
3. Shake excess water out of Unicouple and return it and its hoses to the dishwasher storage compartment.

**NOTE:** When motor stops at the end of the final rinse, the Unicouple can be disconnected and returned to storage.



## Questions? Use This Problem Solver

PROBLEM	POSSIBLE CAUSE AND REMEDY
DISHWASHER WON'T RUN	A fuse in your home may be blown, or the circuit breaker tripped. Replace fuse or reset circuit breaker. Remove any other appliances from the circuit.
UNUSUAL NOISE	Utensils may not be secure on rack pins. Or something small may have dropped from the rack. Water is causing cookware to rattle. Make sure everything is securely placed in dishwasher.
DISHES DON'T DRY	Make sure inlet water temperature is correct. (See page 6.) Unload the bottom rack first. Water from dishes in the top rack may be spilling into the bottom rack. Check for improper loading. Dishes shouldn't nest together. Avoid overloading.
UNCLEAN DISHES AND FLATWARE	Check inlet water temperature. It should be at least 120°F. (To test, see page 6.) To obtain the benefits of a complete cycle, be careful that you do not turn the dial any further than necessary to start the dishwasher. Water pressure may be temporarily low. Turn on a faucet. Is water coming out slower than usual? If so, wait until pressure is normal before using your dishwasher. Improper rack loading. (See pages 8-9.)
BLACK OR GRAY MARKS ON DISHES	Aluminum deposits often leave marks when they rub against other things. Remove marks with a mild abrasive cleanser.
SPOTS AND FILMING ON GLASSES AND FLATWARE	Spotting can be caused by all these things: <ul style="list-style-type: none"><li>• Extremely hard water. (See page 6.)</li><li>• Low inlet water temperature. (To test, see page 6.)</li><li>• Overloading the dishwasher.</li><li>• Improper loading. (See pages 8-9.)</li><li>• Old or damp powder detergent.</li><li>• Phosphate level in detergent too low. (See page 6.)</li><li>• Too little detergent. (See page 6.)</li></ul> Due to varying local water conditions and personal preferences, try several brands of detergents to find one that gives the best results for you. A liquid dishwashing detergent may help reduce filming. <b>To remove severe spots and film from glassware:</b> <ol style="list-style-type: none"><li>1. Remove all metal cookware from the dishwasher.</li><li>2. Do not add detergent.</li><li>3. Select NORMAL WASH cycle.</li><li>4. Start the dishwasher and allow to run for 15 to 20 minutes. The dishwasher will now be in the main wash.</li><li>5. Then open the door and pour 2 cups (500 ml) of white vinegar into the bottom of the dishwasher.</li><li>6. Close the door and allow to complete the cycle.</li></ol> If vinegar rinse doesn't work: Repeat as above, except use 1/4 cup (60 ml) of citric acid crystals instead of vinegar. (Most drugstores carry citric acid crystals. If yours doesn't, call GE Factory Service.) Using a vinegar or citric acid crystal rinse more than twice a month? Consider a home water softener.

(continued next page)

## The Problem Solver (continued)

PROBLEM	POSSIBLE CAUSE AND REMEDY
DETERGENT LEFT IN DISPENSER CUPS	<p>Water may not be reaching the detergent cups. Move dishes that may be blocking detergent cup.</p> <p>The dispenser cover may not be opening or may be blocked by improperly loaded items. If you used a powder detergent, open the cup and remove any caked-on detergent. If the cup still doesn't open automatically, call for service.</p> <p>Detergent may be old. If the powder detergent is hard or caked in the box, throw it away. The detergent may not be working well. Try another brand.</p>
DETERGENT CUP WON'T LATCH AFTER ADDING DETERGENT	<p>Cycle Indicator dial must be in OFF position for cup to close and latch properly. If you unlatch the door and open it to dry your dishes, the Cycle Indicator does not advance to OFF by itself.</p>
CLOUDINESS ON GLASSWARE	<p>If vinegar or citric acid crystal rinse doesn't work, the cloudiness is "etching." The film cannot be removed.</p> <p><b>It can be prevented:</b> Use less detergent if you have soft water. Wash glassware in the shortest cycle that will get them clean.</p> <p>Water temperature entering dishwasher exceeds 150°F.</p>
YELLOW OR BROWN FILM	<p>Tea or coffee can stain cups. Remove the stains by hand, using a solution of 1/2 cup bleach and 3 cups warm water.</p> <p>An overall yellow or brown film on dishes or glassware can be caused by iron deposits in water. A special filter in the water supply line is the only way to correct this problem. Your water softener company can tell you about the filter.</p> <p>Yellow film on sterling silver results when you wash copper utensils in the same load. Silver polish will usually remove this stain.</p>
CHIPPING OF CHINA	<p>Rough handling can cause chipping. Load with care. Make sure glassware and china are secure and can't jar loose. (See pages 8 and 9 for correct way to load glassware.) Make sure tall glasses and stemware will clear the top of the tub when you push the rack into the dishwasher. Always use the top rack for delicate items.</p>
SMALL AMOUNT OF WATER STANDING IN THE BOTTOM OF THE TUB	<p>Water around the outlet on the tub bottom at the back of the tub is normal. It is clean water. It's there to keep the water seal lubricated.</p>
WATER WON'T PUMP OUT OF THE TUB	<p>If the entire bottom of the tub has water, you may have a drain problem. Check the kitchen sink. Is it draining well? You may need a plumber.</p> <p>If dishwasher drains into disposer, run disposer to clear. Be sure disposer is not clogged.</p>
SUDS IN THE TUB	<p>Sudsing detergents are not meant for dishwashers. <b>USE ONLY AUTOMATIC DISHWASHER DETERGENTS TO AVOID SUDSING.</b></p> <p><b>To remove suds from the tub:</b> Open the dishwasher. Let suds evaporate. Add 1 gallon of cold water to the tub. Close and latch the dishwasher. Pump out water by slowly turning the control dial until a drain period is reached. Repeat if necessary.</p>
DISHWASHER LEAKS	<p>Suds can cause unit to overflow. That's why it's so important to use a detergent that's designed for automatic dishwashers.</p>

If you need more help...call, toll free:  
 GE Answer Center®  
 800.626.2000  
 consumer information service

## Care and Cleaning

### USER MAINTENANCE INSTRUCTIONS

Clean the control panel with a lightly dampened cloth. Dry thoroughly. Do not use abrasives or sharp objects on the panel. They can damage it.

Clean the outside with a good appliance polish wax. The outside cabinet finish is durable, but it can scratch. So use no scouring pads or harsh or gritty cleaners.

Appliance Polish Wax & Cleaner (Cat. No. WR97X216) is available from GE Appliance Parts Marts.

The inside usually takes care of itself. If it should ever need cleaning, use a mild cleansing powder. Scouring pads and harsh cleaners can mar the finish.

### Conversion Kit

A special kit (Cat. No. WD35X5073) for changing a convertible dishwasher to a permanent built-in installation is available from your dealer or service organization.

### How to prepare your dishwasher for winter storage

If the dishwasher is to be left unused in an unheated location during the winter months, have a service technician take the following steps to prevent the machine from freezing:

- Remove fuses or trip circuit breakers to remove electric power from the dishwasher.
- Turn off water to dishwasher. Disconnect the water inlet line from the water valve and drain.
- Remove water valve from the dishwasher and blow on small plastic outlet to remove water. Replace water valve and water line.
- Remove plug in bottom of rubber boot and drain completely. Replace the plug.

### Removing the Wood Top

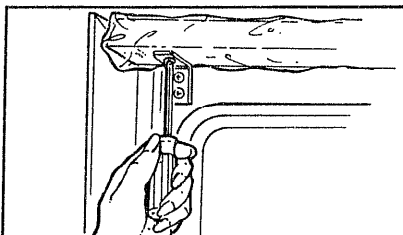

Remove the two mounting screws as shown and pull the top toward you to remove it from the dishwasher.

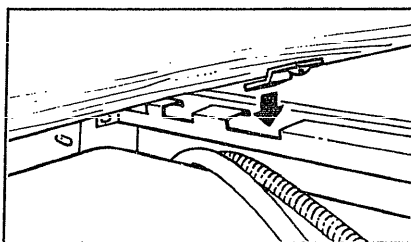

To remove the protective cover, use a scissor to cut the bag from the under side. Then reinstall the top taking care to engage the rear brackets as shown.

DO NOT operate the dishwasher without the wood top in place.

### Care of the wood top

Before using, wipe well with a dry cloth to remove surface dust. Saturate a clean cloth with mineral oil and polish all exposed wood surfaces until they gleam. Allow wood top to stand overnight to absorb the oil and repeat the treatment the next day. Allow to stand for 4 to 6 hours and wipe off excess oil with a soft, dry cloth.

Wood tops should not be used as a place for thawing frozen foods, even when protected by a sheet of aluminum foil. Never let water stand on the wood top.

To remove water stains, rub with a cloth saturated with non-toxic mineral oil (available at most drugstores).

Should your top become too stained, dirty or cut, sand with #000(150) or #0000(220) sandpaper and then wipe with a cloth saturated with non-toxic mineral oil.

## If You Need Service

To obtain service, see your warranty on the back page of this book.

We're proud of our service and want you to be pleased. If for some reason you are not happy with the service you receive, here are three steps to follow for further help.

**FIRST**, contact the people who serviced your appliance. Explain why you are not pleased. In most cases, this will solve the problem.

**NEXT**, if you are still not pleased, write all the details—including your phone number—to:

Manager, Consumer Relations  
GE Appliances  
Appliance Park  
Louisville, Kentucky 40225

**FINALLY**, if your problem is still not resolved, write:

Major Appliance  
Consumer Action Panel  
20 North Wacker Drive  
Chicago, Illinois 60606



# YOUR GENERAL ELECTRIC AUTOMATIC DISHWASHER WARRANTY

Save proof of original purchase date such as your sales slip or cancelled check to establish warranty period.

## WHAT IS COVERED

### FULL ONE-YEAR WARRANTY

For one year from date of original purchase, we will provide, free of charge, parts and service labor in your home to repair or replace **any part of the dishwasher** that fails because of a manufacturing defect.

This warranty is extended to the original purchaser and any succeeding owner for products purchased for ordinary home use in the 48 mainland states, Hawaii and Washington, D.C. In Alaska the warranty is the same except that it is **LIMITED** because you must pay to ship the product to the service shop or for the service technician's travel costs to your home.

All warranty service will be provided by our Factory Service Centers or by our authorized Customer Care® servicers during normal working hours.

Look in the White or Yellow Pages of your telephone directory for GENERAL ELECTRIC COMPANY, GENERAL ELECTRIC FACTORY SERVICE, GENERAL ELECTRIC-HOTPOINT FACTORY SERVICE or GENERAL ELECTRIC CUSTOMER CARE® SERVICE.

## WHAT IS NOT COVERED

- Service trips to your home to teach you how to use the product.

### Read your Use and Care material.

If you then have any questions about operating the product, please contact your dealer or our Consumer Affairs office at the address below, or call, toll free:

GE Answer Center®  
800.626.2000  
consumer information service

- Improper installation.

If you have an installation problem, contact your dealer or installer. You are responsible for providing adequate electrical, plumbing and other connecting facilities.

- Replacement of house fuses or resetting of circuit breakers.

- Cleaning or servicing of air gap device in drain line.

- Failure of the product if it is used for other than its intended purpose or used commercially.

- Damage to product caused by accident, fire, floods or acts of God.

**WARRANTOR IS NOT RESPONSIBLE FOR CONSEQUENTIAL DAMAGES.**

Some states do not allow the exclusion or limitation of incidental or consequential damages, so the above limitation or exclusion may not apply to you. This warranty gives you specific legal rights, and you may also have other rights which vary from state to state. To know what your legal rights are in your state, consult your local or state consumer affairs office or your state's Attorney General.

**Warrantor: General Electric Company**

**If further help is needed concerning this warranty, write:  
Manager—Consumer Affairs, GE Appliances, Louisville, KY 40225**

Part No. 165D3080P050  
Pub No. 49-5403