

This Owner's Manual is provided and hosted by [Appliance Factory Parts](#).



Haier ESD302 Owner's Manual

[Shop genuine replacement parts for Haier ESD302](#)



[Find Your Haier Dishwasher Parts - Select From 53 Models](#)

----- Manual continues below -----

Haier

Built-in Dishwasher

SERVICE MANUAL

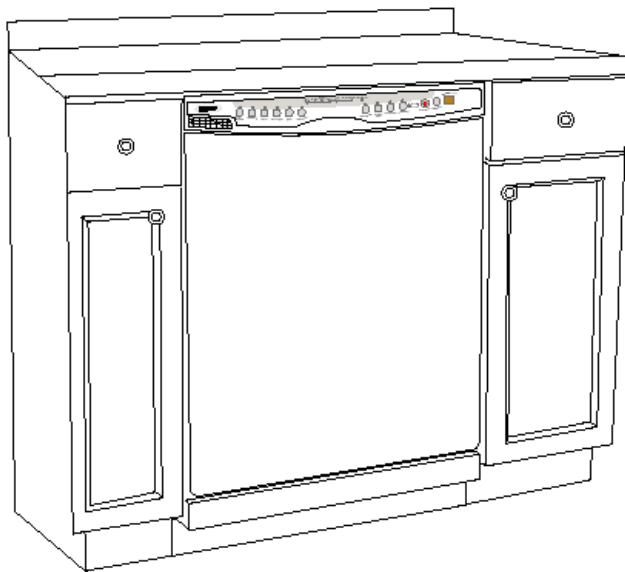

Models
ESD300/ESD301/ESD302
ESD310/ESD311/ESD312

● Features

- Energy Star for energy consumption of USA rules
- Stainless steel Interior tub
- Electronic control
- Triple level filter system
- Three-spraying, higher cleaning ratio
- The capacity for 12 place settings

Part # DW-8888-25



Contents

1.Product Code Illumination and Series Introduction	2
2.Features	2
3.Safety Precaution.....	4
4.Net dimension	4
5.Installation	5
6.Parts and Features	25
7.Control Panel	25
8. Start-Upguide	26
9.Dishwasher Loading	26
10. Dishwasher Use.....	30
11.Washing System	36
12.Drying System.....	36
13.Overflow Protection Float	36
14.Washing special items and dishwasher care.....	37
15. Drain Air Gap	38
16.Storing.....	38
17. Function Schedule	39
18.Maintenances Services and Trouble Shooting	41
19.Circuit Diagram	46

Haier

Built-In Dishwasher

Model: ESD300/ESD301/ESD302/310/311/312

1.Product Code Illumination and Series Introduction

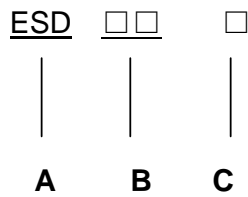
Model Identification**A:** Energy Star Dishwasher**B:** Series of factory design**C:** Code of Color**0:**White **1:**Black **2:**Stainless steel**Examples:****ESD300**

It represents energy star dishwasher of 300 series, the color of appearance is white.

ESD301

It represents energy star dishwasher of 300 series, the color of appearance is black.

ESD302

It represents energy star dishwasher of 300 series, the color of appearance is stainless steel.

2.Features**2.1 Energy Star for energy consumption of USA rules****2.2 Stainless steel Interior tub****2.3 Electronic control****2.4 Triple level filter system****2.5 Three-spraying, higher cleaning ratio****2.6 The capacity for 12 place settings**

Haier

Built-In Dishwasher

Model: ESD300/ESD301/ESD302/310/311/312

3.Safety Precaution

DISHWASHER SAFETY

Your safety and the safety of others are very important

We have provided many important safety messages in this manual and on your appliance. Always read and obey all safety messages.



This is the safety alert symbol.

This symbol alerts you to potential hazards that can kill or hurt you and others.

All safety messages will follow the safety alert symbol and either the word "DANGER" or

"WARNING." These words mean:

⚠ DANGER

You can be killed or seriously injured if you don't immediately follow instructions.

⚠ WARNING

You can be killed or seriously injured if you don't follow instructions.

All safety messages will tell you what the potential hazard is, tell you how to reduce the chance of injury, and tell you what can happen if the instructions are not followed.

IMPORTANT SAFETY INSTRUCTIONS

WARNING: When using the dishwasher, follow basic precautions, including the following:

- Read all instructions before using the dishwasher.
- Use the dishwasher only for its intended function.
- Use only detergents or rinse agents recommended for use in a dishwasher, and keep them out of the reach of children.
- When loading items to be washed:
 - 1) Locate sharp items so that they are not likely to damage the door seal; and
 - 2) Load sharp knives with the handles up to reduce the risk of cut-type injuries
- Do not wash plastic items unless they are marked "dishwasher safe" or the equivalent. For plastic items not so marked, check the manufacturer's recommendations.
- Do not touch the heating element during or immediately after use.
- Do not operate the dishwasher unless all enclosure panels are properly in place.
- Do not tamper with controls.
- Do not abuse, sit on, or stand on the door, lid, or dish racks of the dishwasher.
- To reduce the risk of injury, do not allow children to play in or on the dishwasher.
- Under certain conditions, hydrogen gas may be produced in a hot water system that has not been used for two weeks or more. **HYDROGEN GAS IS EXPLOSIVE.** If the hot water system has not been used for such a period, before using the dishwasher turn on all hot water faucets and let the water flow from each for several minutes. This will release any accumulated hydrogen gas. As the gas is flammable, do not smoke or use an open flame during this time.
- Remove the door or lid to the washing compartment when removing an old dishwasher from service or discarding it.

SAVE THESE INSTRUCTIONS

Haier

Built-In Dishwasher

Model: ESD300/ESD301/ESD302/310/311/312

Before Using Your Dishwasher**⚠ WARNING****Tip Over Hazard**

Do not use dishwasher until completely installed.
Do not push down on open door.
Doing so can result in serious injury or cuts.

⚠ WARNING**Electrical Shock Hazard**

Electrically ground dishwasher
Connect ground wire to green ground connector
in terminal box.
Do not use an extension cord.
Failure to follow these instructions can result in
death, fire, or electrical shock.

- Install where dishwasher is protected from the elements. Protect against freezing to avoid possible rupture of fill valve. Such ruptures are not covered by the warranty. See "Storing" in the "Dishwasher Care" section for winter storage information.
- Install and level dishwasher on a floor that will hold the weight, and in an area suitable for its size and use.
- Remove all shipping plugs from hoses and connectors (such as the cap on the drain outlet) before installing. See Installation Instructions for complete information.

GROUNDING INSTRUCTIONS**For a grounded, cord-connected dishwasher:**

The dishwasher must be grounded. In the event of a malfunction or breakdown, grounding will reduce the risk of electric shock by providing a path of least resistance for electric current. The dishwasher is equipped with a cord having an equipment-grounding conductor and a grounding plug. The plug must be plugged into an appropriate outlet that is installed and grounded in accordance with all local codes and ordinances.

WARNING: Improper connection of the equipment-grounding conductor can result in a risk of electric shock. Check with a qualified electrician or service representative if you are in doubt whether the dishwasher is properly grounded. Do not modify the plug provided with the dishwasher; if it will not fit the outlet, have a proper outlet installed by a qualified electrician.

For a permanently connected dishwasher:

The dishwasher must be connected to a grounded metal, permanent wiring system, or an equipment-grounding conductor must be run with the circuit conductors and connected to the equipment-grounding terminal or lead on the dishwasher.

SAVE THESE INSTRUCTIONS**4.Net dimension**

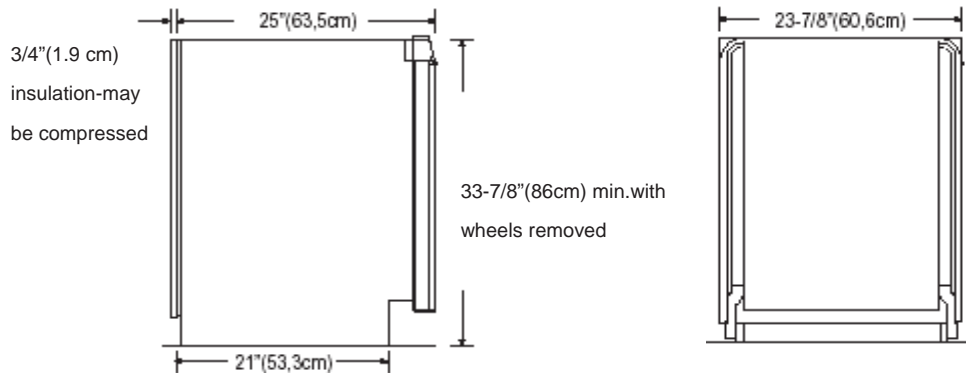
Haier**Built-In Dishwasher****Model: ESD300/ESD301/ESD302/310/311/312**

5. Installation

5.1 Tools and materials needed

- A. pliers
- B. Phillips screwdriver
- C. 5/8" open end wrench
- D. measuring tape or ruler
- E. 10" adjustable wrench that opens to 1-1/8" (2.9cm)
- F. flat-blade screwdriver
- G. gloves
- H. utility knife
- I. 2 twist-on wire connectors, which are the proper size to connect your household wiring to 16-gauge wiring in dishwasher
- J. small level
- K. safety glasses
- L. 90° bow with 3/8" N.P.T external threads on one end. (The other end must fit your water supply line.)
- M. flashlight
- N. Teflon® tape or pipe joint compound
- O. shallow pan
- P. Shim stock (if installed with built-up floor)
- P. electric drill
- Q. 1/2", 3/4" and 1-1/2" hole saw bits
- R. small tubing cutter
- S. wire stripper
- T. 1-1/2"-2" screw-type clamp if connecting to waste-tee
- U. copper tubing (3/8" recommended) or flexible stainless steel braided fill line
- V. clamp connector or conduit connector to fit a 7/8" (2.2cm) diameter hole



Haier**Built-In Dishwasher****Model: ESD300/ESD301/ESD302/310/311/312**

5.2 Parts supplied

- A. 2 drain hose clamps

1-large 1-small

Make sure all these parts are included. See parts list for accessories available for your dishwasher.

- B. 2 No.ST4.2 X 18 Philips-head screws

- C. Drain hose

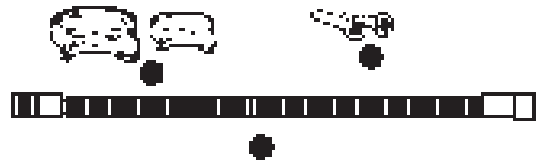

Cabinet opening

Do not run water drain lines or electrical wiring where they can interfere with or contact dishwasher motor or legs.

The location where the dishwasher will be installed must provide clearance between motor and flooring.

Do not install dishwasher over carpeted flooring.

Protect dishwasher and water lines leading to dishwasher against freezing. Damage from freezing is not covered by the warranty.

A side panel kit is available from your dealer for installing your dishwasher at end of cabinet.

Check location where dishwasher will be installed.

The location must provide:

- Easy access to water, electricity and drain.
- Convenient loading. Corner locations require a 2" (5.1cm) minimum clearance between the sides of the dishwasher door and wall or cabinet.
- Square opening for proper operation and appearance.
- Cabinet front perpendicular to floor.
- Level floor .If floor at front of opening is not level with floor at rear of opening, shims may be needed to level dishwasher.

NOTE: Shims must be securely attached to floor to prevent their movement when dishwasher is being operated.

If dishwasher will be left unused for a period of time or in a location where it may be subject to freezing, have it winterized by authorized service personnel.

Make sure pipes, wires and drain hose are within the shaded area.

HELPFUL TIP:

If the floor in the dishwasher opening is uneven (example: tile flooring only part way into opening) you will need to take special care in measuring dimensions and in leveling dishwasher.

Electrical

It is the customer's responsibility:

To contact a qualified electrician. To assure that the electrical installation is adequate and in conformance will all national and local codes and ordinances.

You must have:

- 120-volt, 60Hz, AC-only, 15- or 20-amp., fused electrical supply.
- COPPER WIRE ONLY.

We recommend:

- a time-delay fuse or circuit breaker.
- a separate circuit.

If direct wiring dishwasher

- Use flexible, armored or non-metallic sheathed, copper wire with grounding wire that meets the wiring requirements for your home and local codes and ordinances.
- Use strain relief method provided with house wiring junction box or install a U.L.-listed/CSA-certified clamp connector to the house wiring junction box. If using conduit, use a U.L.-listed/CSA-certified conduit connector.

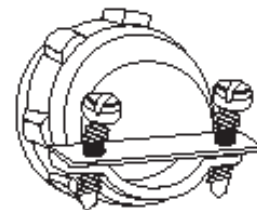

If connecting dishwasher with a power supply cord:

- Use a U.L. -listed, 16-gauge, three-conductor power supply cord that meets all local codes and ordinances. Maximum length of the power supply cord is 6 feet (1.8m).
- a clamp connector to fit a 7/8" (2.2cm) diameter hole is required to secure power supply cord to dishwasher terminal box.
- Power supply cord must plug into a mating three-prong, grounded outlet, located in the cabinet next to the dishwasher opening. Outlet must meet all local codes and ordinances.

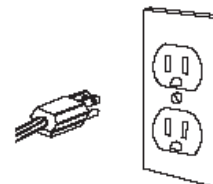

Water

You must have:

- a hot water line with 20-120 PSI (138-862 KPa) water pressure.
- 120°F(49°C) water at dishwasher.
- 3/8"O.D.tubing with compression fitting or flexible stainless steel braided fill line (1/2" minimum plastic tubing is optional but not recommended).
- a 90° elbow with 3/8"N.P.T. external pipe threads on one end.

Do not solder within 6"(15.2cm) from water inlet valve.

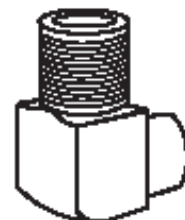

Drain

You must :

- Use the new drain hose supplied with your dishwasher. If this is not suitable, use a new drain hose with a maximum length of 12 feet (3.7 m) that meets all current AHAM/IAPMO test standards, is resistant to heat and detergent, and fits the drain connector on your dishwasher.
- have a high drain loop 20 inches (50.8cm) above the subfloor or floor.
- connect drain hose to waste tee or disposer inlet above drain trap in house plumbing and 20 inches (50.8cm) minimum above the floor.
- use an air gap if the drain hose is connected to house plumbing lower than 20 inches (50.8cm) above subfloor or floor.
- use 1/2" minimum I.D. drain line fittings.

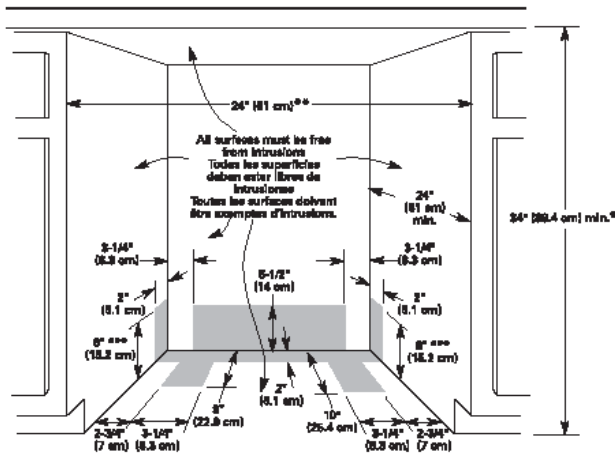
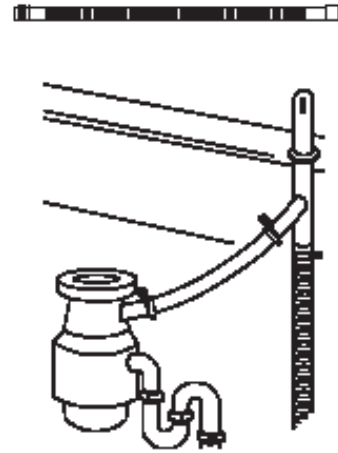

- Measured from the lowest point on the underside of countertop. May be reduced to 33-7/8" (86cm) by removing wheels from dishwasher.
- Minimum, measured from narrowest point of opening.
- Maybe increased to 6-7/8"(17.5cm) if height of opening is 34-1/2"(87.6cm) at lowest point.

Cut openings in shaded area of cabinet walls or floor as specified in chart:

OPENING FOR:	DIANETER:
Water line	1/2" (1.3cm)
drain line	1-1/2" (3.8cm)
direct wire	3/4" (1.9cm)
power supply cord	1-1/2" (3.8cm)



WARNING

Electrical Shock Hazard

Disconnect electrical power at the fuse box or circuit breaker box before installing dishwasher.
Failure to do so can result in death or electrical shock.

A. Prepare cabinet

1.

Disconnect the power supply. Turn water off.
Put on gloves and safety glasses.

2.

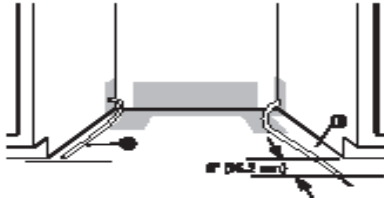

If you are replacing a dishwasher:

- Check that the water line "A" reaches to the back left of opening where the water connection will be made.
 - Check that the direct line "B" reaches to the back left of opening where the electrical connection will be made.
- If the water line and the direct wire reach into the opening far enough, go to step 10, page 10.

If you are installing a new dishwasher , complete all of the following steps:

Electrical

Follow all national and local codes and ordinances for completing electrical supply to cabinet.

If you are:	Use steps:
direct wiring	3,4 and 5
using a power supply cord	3a and 4a

HELPFUL TIP:

Wiring the dishwasher will be easier if you route wire into the cabinet opening from the left side.

Haier

Built-In Dishwasher

Model: ESD300/ESD301/ESD302/310/311/312

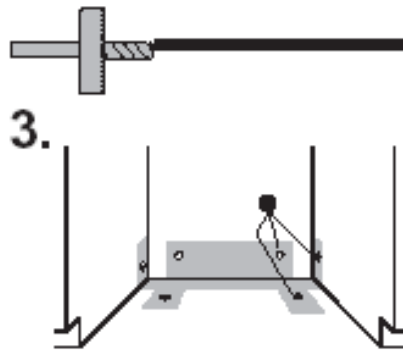
**Direct wire method:****3.**

Cut a 3/4" (1.9cm) hole "C" in righthand cabinet side, rear or floor. Optional locations are shown.

Wood Cabinet: Sand hole until smooth.

**4.**

Run wire into house wiring junction box. Use strain relief method provided with junction box. If no strain relief is provided, install a U.L.-listed/CSA-certified clamp connector for flexible-type wire. If installing conduit, attach a U.L.-listed/CSA-certified conduit connector to junction box.

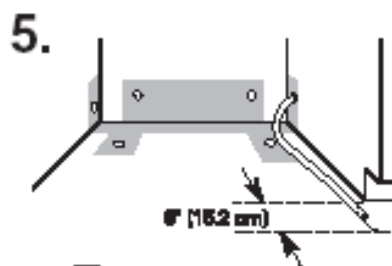
**5.**

Run other end of wire through cabinet hole. Cable must extend to the left front of cabinet opening. Go to step 6.

**Power supply cord method:****3a.**

Cut a 1-1/2" (3.8cm) hole "D" in left-hand cabinet rear or side. Optional locations are shown.

Wood cabinet: Sand hole until smooth.

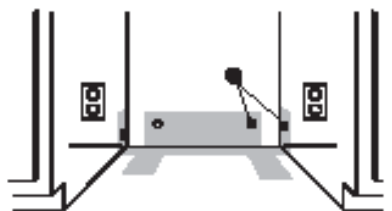
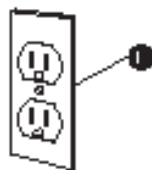
**4a.**

Install a mating, three-prong, grounding-type wall receptacle "E" in the cabinet next to the dishwasher opening. Go to step 6.

Water line

HELPFUL TIP:

Routing the water line through the left side of cabinet opening will make water connection easier.

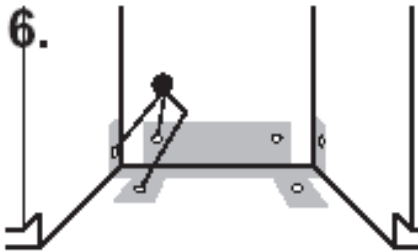
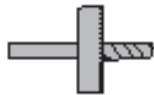

Cut a 1/2" (1.3 cm) minimum hole "F" in left-hand cabinet side, rear or floor. Optional locations are shown. (The hole "F" is about 1-3/5" higher than hole "C" or hole "D")



7.

Measure overall length of copper tubing "G" required. Attach copper tubing to water line with manual shutoff valve. Carefully feed copper tubing through hole in cabinet (copper tubing will bend and kink easily) until it is far enough into the cabinet opening to connect it to dishwasher inlet on the front left of dishwasher.

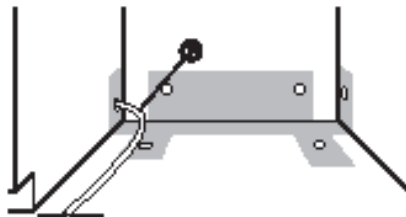

8.

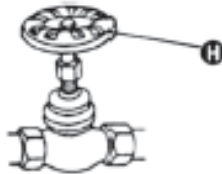

Turn shutoff valve "H" to "ON" position. Flush water into a bucket to get rid of particales that may clog the inlet valve.

9.

Turn shutoff valve to "OFF" position.

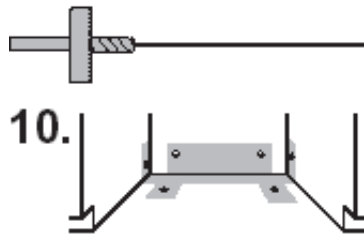

Drain hose

10. Cut a 1-1/2" (3.8cm) diameter hole in cabinet wall or floor on the side of the opening closest to the sink.



11.

Connect drain hose to waste tee or waste disposer following one method.

If you have:	and:	go to step:
a waste disposer	an air gap	11a.
	no air gap*	11c.
no waste disposer	an air gap	11b.
	no air gap*	11d.

*an air gap is recommended



Waste disposer + air gap

11a.

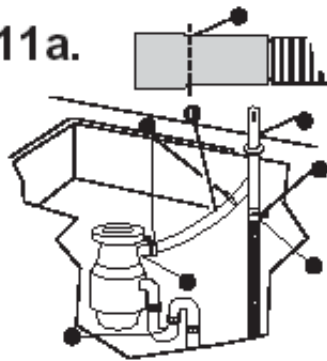

1. Remove the disposer knockout plug. Cut end of drain hose "I" if needed (do not cut ribbed section).
2. Attach drain hose to air gap "J" with large spring-type clamp "K". If the drain hose was cut, use a 1-1/2" to 2" (3.8 to 5 cm) screw-type clamp*.
3. Use a rubber hose connector* "L" with spring or screw-type clamps* "M" to connect air gap to disposer inlet "N". This connection "N" MUST be before drain trap "O" and at least 20" (50.8cm) above the floor where dishwasher will be installed. Go to step 12.



No waste disposer + air gap

11b.

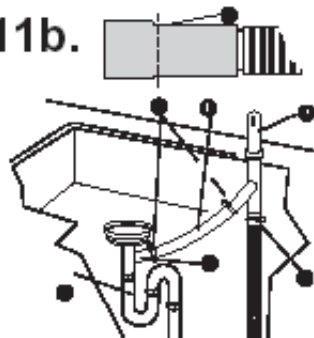

1. Cut end of drain hose "I" if needed (do not cut ribbed section).
2. Attach drain hose to air gap "J" with large spring-type clamp. If the drain hose was cut, use a 1-1/2" to 2" (3.8 to 5 cm) screw-type clamp*.
3. Use a rubber hose connector* "L" with spring or screw-type clamps* "M" to connect air gap to waste tee "P". This connection "P" MUST be before drain trap "O" and above the floor at 15-4/5"(40cm)to 39-2/5"(100cm), at least 20" (50.8 cm) above the floor where dishwasher will be installed. Go to step 12.

Haier

Built-In Dishwasher

Model: ESD300/ESD301/ESD302/310/311/312

11c.**Waste disposer, no air gap**

1. Remove the disposer knockout plug.
Do not cut end of drain hose.
 2. Attach drain hose "I" to disposer inlet "N" with large spring-type clamp "K".
- This connecting "N" MUST be before drain trap "O" and at least 20" (50.8 cm) above the floor where dishwasher will be installed. Go to step 12.

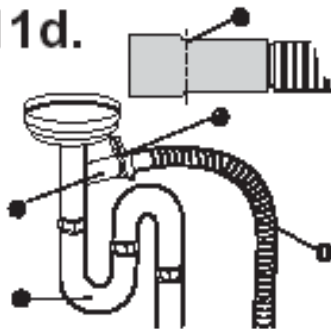
**11d.****No waste disposer + air gap**

1. Cut end of drain hose "I" (do not cut ribbed section).
 2. Attach drain hose to waste tee "P" with 1-1/2" to 2" (3.8 to 5 cm) screw-type clamp "M".
- This connection "P" MUST be before drain trap "O" and at least 20" (50.8 cm) above the floor where dishwasher will be installed. Go to step 12.

* Parts available from local plumbing supply stores.

HELPFUL TIP:

To reduce the vibration of the hose, keep the hose away from the floor and the edge of the hole where it passes through the cabinet.

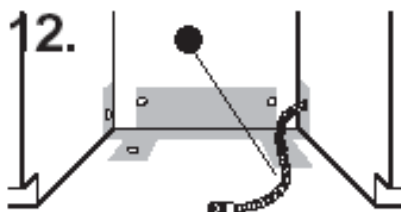
**12.**

Insert drain hose "I" into hole cut in cabinet to the back center of opening where drain connection will be made.

B. Prepare dishwasher

! WARNING



Tip Over Hazard

Do not use dishwasher until completely installed.

Do not push down on open door.

Doing so can result in serious injury or cuts.

! WARNING

Excessive Weight Hazard

Use two people to move and install dishwasher.

Failure to do so can result in back or other injury.

1.

Grasp sides of dishwasher door and put dishwasher on its back.



2.

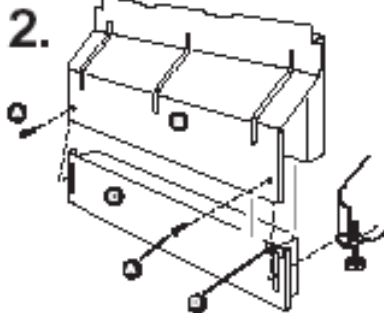

Remove two screws "A" attaching access panel "B" and lower panel "C" to dishwasher using a 1/4" hex socket, nut driver or Philipis screwdriver. remove panels and set panels aside on a protective surface. Check that grounding clip "D" is attached to the lower panel.



3.



Apply pipe joint compound "E" to 90°elbow fitting "F" and connect fitting to water inlet valve "G". Tighten elbow until snug, and be sure that it faces to the rear.



4.



Remove terminal box cover "H". Pull appliance wires "I" through hole in terminal box. Do not untie the knot in the wires.

If you are direct wiring: install a U.L.-listed/CSA-certified clamp connector "J" to the terminal box.If using conduit use a U.L.-listed/CSA certified conduit connector.

If you are installing a power supply cord kit, do so now and follow kit instructions.

HELPFUL TIP:

Put cardboard under dishwasher until it is installed opening. The cardboard will help protect floor covering during installation.



5.

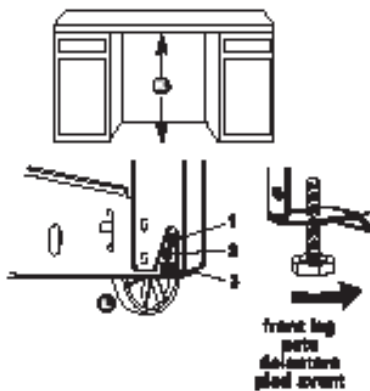

Measure height of cabinet opening from underside of countertop to floor where dishwasher will be installed "K" (you need the lowest point).Check chart for that height opening.Put wheels "L" in the required position.Turn both front leveler legs to the same height.

Min. cabinet height	Wheel position (see illustration)	Number of turns on front leg
34"(86.4 cm)	1	10
34-1/4"(87 cm)	2	5
34-1/2"(87.6 cm)	3	0

If the minimum cutout height is less than 34" (86.4 cm), the adjust legs can be removed for additional clearance. This will allow the dishwasher to fit into a 33 4/5" (85.9 cm) high cutout, but the dishwasher will be more difficult to move into position. If the wheels are removed, protect the floor when moving the dishwasher.

HELPFUL TIP:

Built-up floors.

Measure height of opening from underside of countertop to built-up floor. If the height is at least 33-3/4"(84.5cm), the dishwasher will fit into the opening without modification to the countertop or flooring.

Put wheels "L" in position 1 and turn the front leveler legs up all the way.

Add shims as needed in the area shown to bring dishwasher up to proper height.

Note: Shims must be securely attached to floor to prevent their movement when the dishwasher is operated.

6. Stand dishwasher upright.

7.

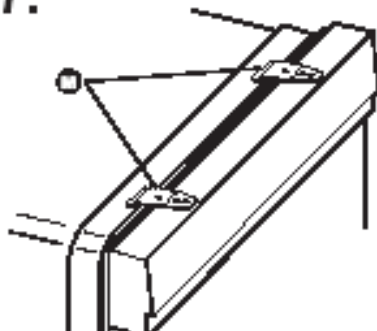

The dishwasher must be secured to the cabinet. There are two brackets on top of the dishwasher that usually can be attached to the countertop. If this is not possible, the brackets "M" may be moved to the sides of the dishwasher.

If you are going to attach the dishwasher to the countertop, skip to step 13.

If you are going to attach the dishwasher to the sides of the cabinet, follow steps 8 through 12.

If the minimum cutout height is less than 34" (86.4 cm), the adjust legs can be removed for additional clearance. This will allow the dishwasher to fit into a 33 4/5" (85.9 cm) high cutout, but the dishwasher will be more difficult to move into position. If the wheels are removed, protect the floor when moving the dishwasher.

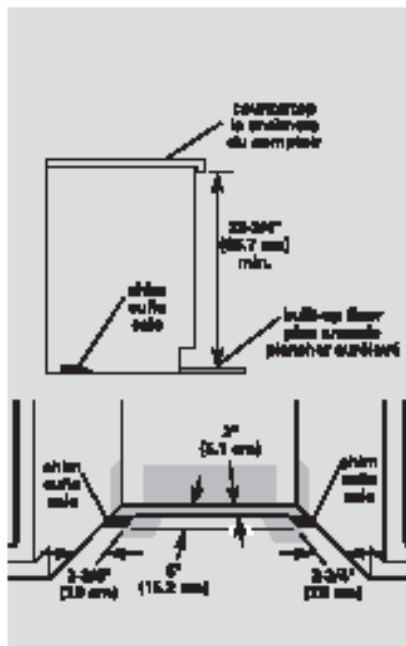

HELPFUL TIP:

Built-up floors.

Measure height of opening from underside of countertop to built-up floor. If the height is at least 33-3/4" (84.5cm), the dishwasher will fit into the opening without modification to the countertop or flooring.

Put wheels "L" in position 1 and turn the front leveler legs up all the way.

Add shims as needed in the area shown to bring dishwasher up to proper height.

Note: Shims must be securely attached to floor to prevent their movement when the dishwasher is operated.

6.

Stand dishwasher upright.

7.

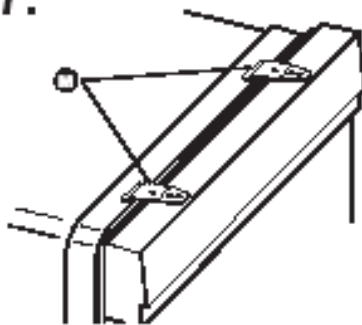

The dishwasher must be secured to the cabinet. There are two brackets on top of the dishwasher that usually can be attached to the countertop. If this is not possible, the brackets "M" may be moved to the sides of the dishwasher.

If you are going to attach the dishwasher to the countertop, skip to step 13.

If you are going to attach the dishwasher to the sides of the cabinet, follow steps 8 through 12.

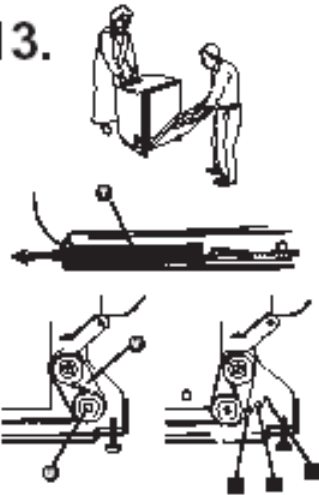
Haier**Built-In Dishwasher****Model: ESD300/ESD301/ESD302/310/311/312****13.**

Check the door spring tension. With another person holding the dishwasher to prevent it from tipping, open and close the door a few times. If the door opens by itself, adjust the door spring tension.

To adjust the door spring tension, unhook the spring "T" from the rear leg of dishwasher. With a 5/16" nut driver or hex socket, remove the screw "U" from the tensioner "V". The screw can be put into one of three holes "1", "2", "3", in front leg of dishwasher. The dishwasher is shipped with the screw in the back hole. If the door opened by itself, move the tensioner to hole "2" or "3" and replace screw. Re-attach door spring to rear leg. Tensioners on both sides of dishwasher should be secured at same holes.

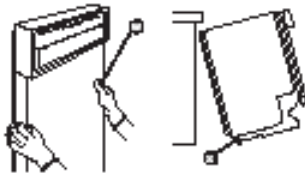
14.

Grasp the dishwasher door at the edges of the door panel "W". Tilt dishwasher backwards on wheels "X". Move dishwasher close to cabinet opening. Do not push on front of panel or on console—they may dent.

15.

If dishwasher has a power supply cord, insert power supply cord into hole cut into cabinet.

16.

Check that water line is on the left side of opening and drain hose is near the center of the hole in the cabinet. If using direct wire, check that it is on the right side of opening.

17.

Carefully move dishwasher completely into cabinet opening. Do not kink or pinch copper tubing, drain hose, power supply cord or direct wire between dishwasher and cabinet.

Center dishwasher in opening.

**HELPFUL TIP:****Built-up floors.**

Tilt dishwasher backward to move into opening.

Once in position, support front of dishwasher by lowering or shimming front feet.

Haier

Built-In Dishwasher

Model: ESD300/ESD301/ESD302/310/311/312

18.

Remove cardboard from under dishwasher.

HELPFUL TIP:

It is okay if dishwasher fits tightly into cabinet opening. Do not remove insulation blanket-it reduces the sound level.

19.

Align front of dishwasher door panel "Y" with cabinet doors "Z". You may need to adjust alignment to look good with your cabinets.

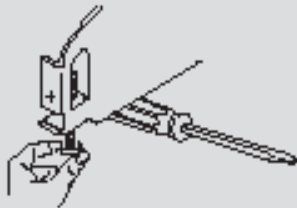
**HELPFUL TIP:**

Prop up one side of frame to hold dishwasher up off floor when adjusting front legs.

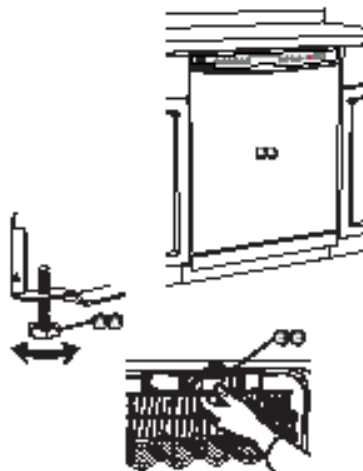
**20.**

Check that leveling legs "AA" are firmly against the floor. Close and latch the door, and place level against the front panel "BB". Check that dishwasher is plumb. Adjust leveling leg or add shims under rear wheel until dishwasher is level. Note: Shims must be securely attached to floor to prevent their movement when the dishwasher is operated. Repeat for other side of dishwasher.

NOTE: Shims must be securely attached to floor to prevent their movement when the dishwasher is operated. Repeat for other side of dishwasher.

Place level against top front opening of tub "CC". Check that dishwasher is level from side to side. If dishwasher is not level, adjust front legs up or down until dishwasher is level.

Haier

Built-In Dishwasher

Model: ESD300/ESD301/ESD302/310/311/312

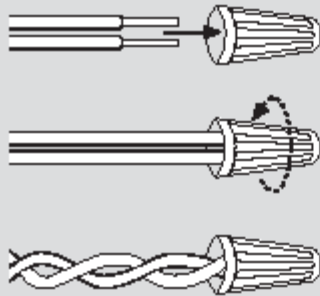
**HELPFUL TIP:**

- Select the proper size twist-on connectors to connect your household wiring to 16-gauge dishwasher wiring.
- Insert wire ends into twist-n connector. Do not pre-twist bare wire.
- Twist connector.
- Gently tug on wires to be sure both are secured.

2.

Connect the wire "B" as follows using twist-on connectors "C" sized to connect direct wire to 16-gauge dishwasher wire:

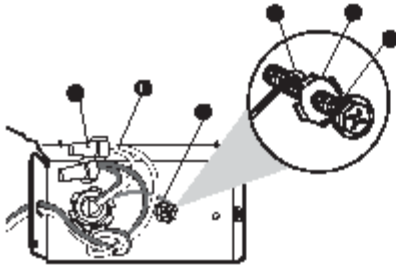

From bare ground wire "D" into a U-shaped hook. Wrap ground wire hook clockwise around ground connector "E" and under the washer "F". Securely tighten ground connector "E" and under the washer "F". Securely tighten ground connector "E". Do not untie knot in the wires.

Power supply wire:		Terminal box wire:
White	←→	White
Black	←→	black
Ground wire	←→	Ground connector

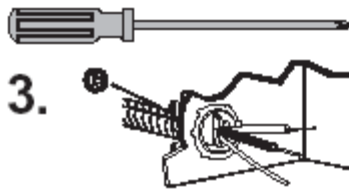
**3.**

Tighten clamp connector or conduit connector screws "G".

**4.**

Reinstall terminal box cover "H" with wires inside terminal box. Go to step 5. The cover must be outside the box on the right side. Make sure no wires are pinched by cover.

Haier

Built-In Dishwasher

Model: ESD300/ESD301/ESD302/310/311/312

1a.

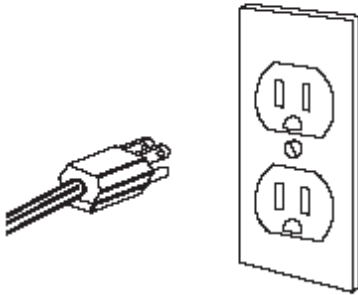
**Power supply cord method:****! WARNING****Electrical Shock Hazard**

Plug into a grounded 3 prong outlet.
Do not remove ground prong.
Do not use an adapter.
Do not use an extension cord.
Failure to follow these instructions can result in death, fire, or electrical shock.

Check that power supply cord does not touch dishwasher motor or lower part of dishwasher tub. Go to step 5.

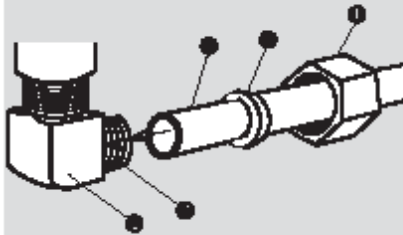
Water Connection**HELPFUL TIP:****Compression fittings:**

1. Slide nut "I" onto copper tubing "J" about 1 inch (2.5 cm).
2. Slide ferrule "K" onto the tubing. Do not position ferrule on the end of the tubing.
3. Put the tubing into the elbow "L" as far as it will go.
4. Slide the nut and ferrule forward and start the nut onto the elbow threads "M". Be careful when handling and positioning the copper tubing. It bends and kinks easily.

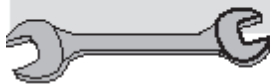

5.

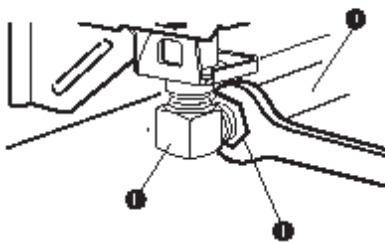

To prevent vibration during operation, route the water supply line so that it does not touch the dishwasher base, frame or motor.

Make sure the water line stays within the shaded area shown on page 7 when the dishwasher is installed in the cabinet. With copper tubing "J" pushed into compression fitting as far as it will go, use an adjustable wrench and tighten compression fitting nut "I" to elbow "L" on water inlet valve.

6.

Place Paper towel under elbow. Turn on water supply and check for leaks.

Drain Connection

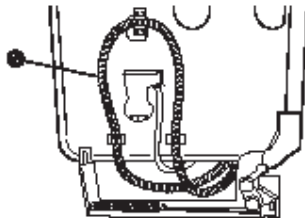
7.

To help minimize vibration noise, route drain hose to avoid contact with motor, door springs, water line, cabinet, flooring or the edge of the hole where it passes through the cabinet. Do not remove drain loop "N" from side of dishwasher.

8.

Place the smaller drain hose clamp "N" onto the small end of the drain hose "O". Remove the plug from the connector "P".

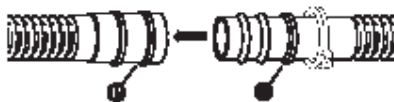
9.

Push the drain hose into the connector "P" up to the rib "O" on the drain hose.

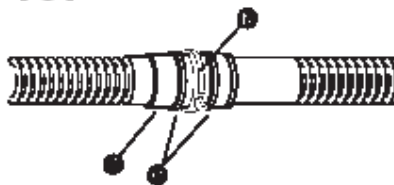
**10.**

Use pliers to open clamp "N" and slide clamp onto connector "P" between ribs "O" on connector.

Haier

Built-In Dishwasher

Model: ESD300/ESD301/ESD302/310/311/312

D. Secure Dishwasher

⚠ WARNING



Tip Over Hazard

Do not use dishwasher until completely installed.

Do not push down on open door.

Doing so can result in serious injury or cuts.

1.



Open dishwasher door and place towel "A" over pump assembly and spray arm of dishwasher. This will prevent screws from falling into pump area when securing dishwasher to countertop.

2.

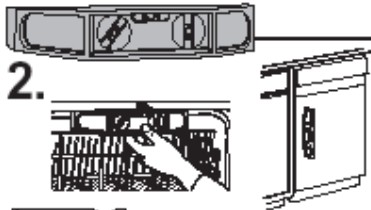

Check that dishwasher is still level and centered in the opening.

3.

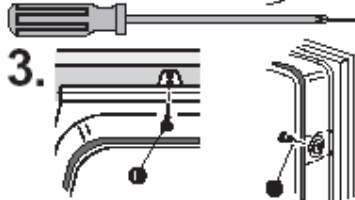

Secure dishwasher to countertop with two, No. ST4.2 x18 Phillips-head screws "B". The dishwasher **MUST** be secured to keep it from tipping when door is opened. Do Not drop screws into bottom of dishwasher.

4.

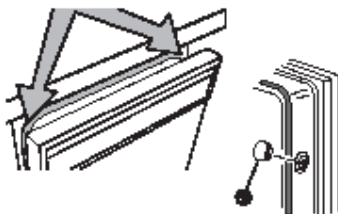

Open door about 3 inches (7.6 cm) and check that space between inner door and tub is equal on both sides. If spacing is not equal, loosen bracket screws and shift tub. Tighten bracket screws. If securing to sides of cabinet, replace the plastic buttons "C".

Check that top of door does not contact screws, brackets, or countertop. If it does, dishwasher must be lowered and re-leveled. Remove paper or towel from dishwasher.

Haier

Built-In Dishwasher

Model: ESD300/ESD301/ESD302/310/311/312

D. Secure Dishwasher

⚠ WARNING



Tip Over Hazard

Do not use dishwasher until completely installed.

Do not push down on open door.

Doing so can result in serious injury or cuts.

1.



Open dishwasher door and place towel "A" over pump assembly and spray arm of dishwasher. This will prevent screws from falling into pump area when securing dishwasher to countertop.

2.

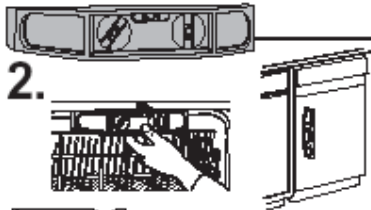

Check that dishwasher is still level and centered in the opening.

3.

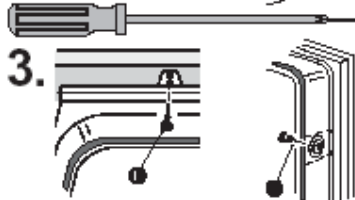

Secure dishwasher to countertop with two, No. ST4.2 x18 Phillips-head screws "B". The dishwasher **MUST** be secured to keep it from tipping when door is opened. Do Not drop screws into bottom of dishwasher.

4.

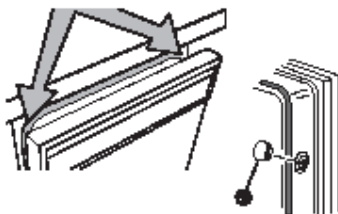

Open door about 3 inches (7.6 cm) and check that space between inner door and tub is equal on both sides. If spacing is not equal, loosen bracket screws and shift tub. Tighten bracket screws. If securing to sides of cabinet, replace the plastic buttons "C".

Check that top of door does not contact screws, brackets, or countertop. If it does, dishwasher must be lowered and re-leveled. Remove paper or towel from dishwasher.

6. PARTS AND FEATURES



- | | |
|--------------------------------------|-------------------------------|
| 1. Upper spray | 8. Adjustable Top rack |
| 2. Upper rack track | 9. Middle spray arm |
| 3. Water inlet opening [in tub wall] | 10. Silverware basket |
| 4. Spray arm | 11. Overfill protection float |
| 5. Bottom rack | 12. Heating element |
| 6. Vent system | 13. Detergent dispenser |
| 7. Utility shelf[two] | |

7. Control Panel

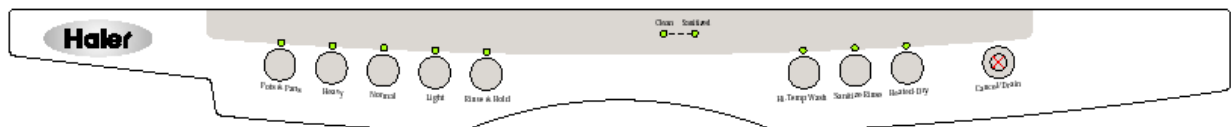

8.START-UPGUIDE

Before using your dishwasher, remove all packaging materials.

Using New Dishwasher

1. Rinse aid is essential for good drying. Be sure to fill the dispenser before you use your new dishwasher. Each filling will last about 1 to 3 months depending on your usage.
2. Scrape large food soil and hard items (toothpicks or bones) from dishes. You do not need to pre-rinse your dishes.
3. Properly load the dishwasher. (See " Dishwasher Loading.") Load dishes with space in between so water will reach the soiled surfaces. Make sure nothing prevents the spray arm(s) from spinning freely.

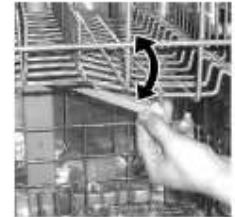

4. Add detergent. Always use a quality brand detergent.
5. Close the door.



6. Press the desired cycle and option selections. The dishwasher starts filling when you press a cycle. You can select options as the machine fills (See " Dishwasher Use.")

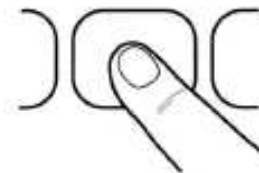

9.DISHWASHER LOADING

-Remove leftover food, bones, toothpicks and other hard items from the dishes. To conserve water, energy and save time, it is not necessary to rinse dishes before putting them into the dishwasher. The wash module removes food particles from the water. The module contains a chopping device, which will reduce the size of food items.

NOTE: If hard items such as fruit seeds, nuts, and eggshells enter the wash module, you might hear chopping, grinding, crunching, or buzzing sounds. These sounds are normal when hard items enter the module. Do not let metallic items (such as pot handle screws) get into the wash module.

Damage can occur.

-It is important for the water spray to reach all soiled surfaces.

-Load dishes so they are not stacked or overlapping if possible. For best drying, water must be able to drain from all Surfaces

Haier**Built-In Dishwasher****Model: ESD300/ESD301/ESD302/310/311/312**

-Load heavy pots and pans carefully. Heavy items can dent the stainless steel interior of the door if they are dropped or bumped.

-Make sure pot lids and handles, pizza pans, cookie sheets, etc., do not interfere with the spray arm rotation.

-Conserve water, energy and save time over hand rinsing by running a rinse cycle to keep dishes moist if you do not plan to wash them soon. Foods such as eggs, rice, pasta, spinach, and cooked cereals may be hard to remove if they are left to dry over a period of time.

Quiet operating tips

-To avoid thumping/clattering noises during operation: Make sure lightweight load items are secured in the racks.

-Make sure pot lids and handles, pizza pans, cookie sheets, etc., do not touch interior walls or interfere with the rotation of the spray arm.

-Load dishes so they do not touch one another.

NOTE: For built-in models, keep sink drain plugs closed during dishwasher operation to prevent noise transfer through drains.

9.1 Loading Top Rack

The top rack is designed for cups, glasses, and smaller items. Many items, up to 9 in. (22 cm), fit in the top rack. (See recommended loading patterns shown.)

NOTE: The features on your dishwasher rack may vary from the drawings shown.

-Place items so open ends face down for cleaning and draining.

-Load glasses and cups in top rack only. The bottom rack is not designed for glasses and cups. Damage can occur.

-Place cups and glasses in the rows between tines. Placing them over the tines can lead to breakage and water spots.

-China, crystal, and other delicate items must not touch each other during dishwasher operation. Damage may occur.

-Load plastic items in the top rack only. Only plastic items marked "dishwasher safe" are recommended.

-Load plastic items so the force of the spray does not move them during the cycle.

-To avoid chipping, do not let stemware touch other items.

-Small bowls, pans, and other utensils can be placed in the top rack. Load bowls in the center section for best stability.

Utility shelf

Fold down the extra shelf on the left or right side of the top rack to hold additional cups, stemware or long items such as utensils and spatulas.

Adjustable 2-position top rack

You can raise or lower the top rack to fit tall items in either the top or bottom rack. Raise the top rack to accommodate items up to 7.1 in. (18 cm) in the top rack and 12.2 in. (31 cm) in the bottom rack, or lower the top rack to accommodate items up to 9 in. (23 cm) in the top rack and 10.2 in. (26 cm) in the bottom racks.

Adjusters are located on each side of the top rack.



12 place setting

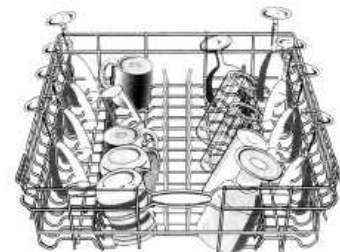

Cup and glass load

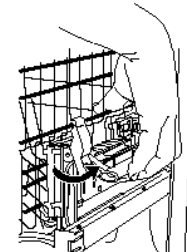
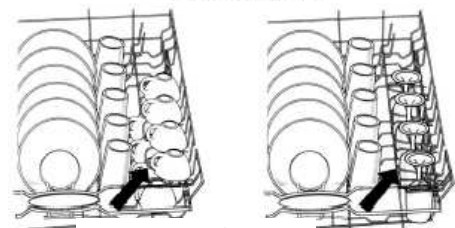

To remove the top rack

Haier**Built-In Dishwasher****Model: ESD300/ESD301/ESD302/310/311/312**

1. Pull the rack forward slightly to access track stops.
2. To release, press the button of the track stop and pull track stop out of the track.
3. After removing both track stops, pull rack out.

To replace the top rack

1. Place the rollers on each side of the rack into the rack tracks and push the rack back.
2. Insert track stop into rack .
3. Pull on the track stop to make sure it is locked into place.
4. Repeat on the other side.

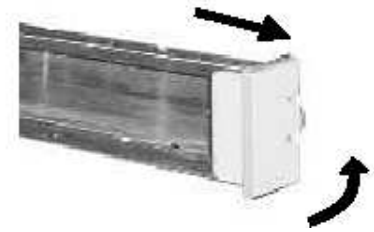
**9.2 Loading Bottom Rack**

The bottom rack is designed for plates, pans, casseroles, and utensils. Many items, up to 12.2 in. (31 cm) tall, fit in the bottom rack. (See recommended loading patterns shown.)

NOTE: The features on your dishwasher rack may vary from the drawings shown.

- Do not load glasses, cups, or plastic items in the bottom rack. Load small items in the bottom rack only if they are secured in place.
- Load plates, soup bowls, etc., between tines.
- Overlap the edges of Plates for large loads.
- Load soup, cereal, and serving bows in the rack in a variety of ways depending upon their size and shape.
- Load bowls securely between the rows of tines. Do not nest bowls because the spray will not reach all surfaces.

Utensil load

- Load cookie sheets, cake pans, and other large items at the sides and back. Loading such items in front can keep the water spray from reaching the detergent dispenser.
- Secure heavily soiled cookware face down in the rack.
- Make sure pot handles and other items do not stop rotation of the spray arm(s).
- The spray arm(s) must move freely.
- Do not load items between the bottom rack and the side of the dishwasher tub because they might block the water inlet opening.

NOTE: Spin the spray arms. Be sure items in the basket do not stop the rotation of the spray arms.

You can fold down two rows of tines at the front of the bottom rack.

Fold-down rack

1. Grasp the tip of the tine that is in the tine holder.
2. Gently pull the tine out of the tine holder.
3. Lay the row of tines down in the rack to make room for larger dishes, bowls, pots, pans or roasters.

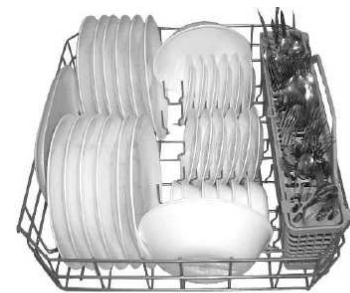

12 Place setting



Utensil load

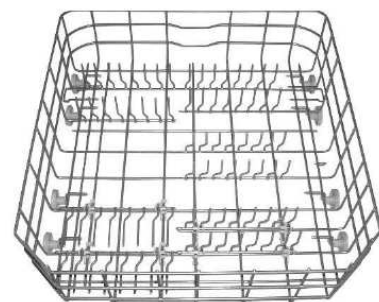

Fold-down rack

9.3 Loading Silverware Basket

Haier**Built-In Dishwasher****Model: ESD300/ESD301/ESD302/310/311/312**

-Load the silverware basket while it is in the bottom rack or take the basket out for loading on a counter or table .(See recommended loading pattern shown)



NOTE: Unload or remove the basket before unloading the racks to avoid spilling water droplets on the silverware .

-Load items with covers down, using the separators, to prevent silverware nesting .

-Place small items such as baby bottle caps , jar lids ,corncob holders , etc., in the section(s) with hinged cover(s) Close the cover to hold small items in place .

IMPORTANT : Always load sharp items(knives, skewers, etc.) pointing down.

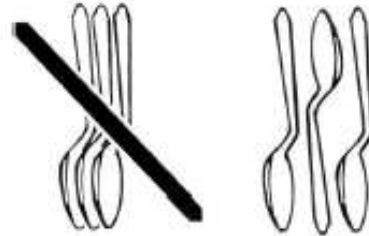

-Do not load silver or silver-plated silverware with stainless steel .These metals can be damaged by contact with each other during washing.

-Some foods (such as salt , vinegar, milk products , fruit juices, etc., can pit or corrode silverware . Run a rinse cycle if you do not have a full load to wash immediately.

10. DISHWASHER USE

10.1 Proper Use of Detergent

Use only detergent specifically made for use in dishwashers. **Cascade, Cascade Complete** and **Electrasol** Automatic Dishwashing Detergents have been approved for use in all Haier dishwashers. Keep your detergent fresh and dry. Don't put powder detergent into the dispenser until you're ready to wash dishes.

All wash cycles except RINSE ONLY require detergent in the main and pre-wash cup.

10.2 Detergent Dispenser

The detergent dispenser has 2 sections . the small Pre-Wash section empties detergent into dishwasher when you close the door .

The larger Main wash section automatically empties detergent into the dishwasher during the wash (See the "cycle Selection Charts")

Use automatic dishwashing detergent only .Other detergents can produce excessive suds that can overflow out of the dishwasher and reduce washing performance .

Add detergent just before starting a cycle.

Store tightly closed detergent in a cool , dry place. Fresh automatic dishwasher detergent results in better cleaning .

NOTE: Do not use detergent with a rinse cycle.

Filling the dispenser

1. If the dispenser over is closed ,open the cover by pushing the cover latch .

2. Fill the Main Wash section with detergent. See "How much detergent to use ".

3. Fill the Pre-Wash section , if needed.

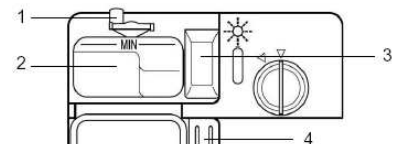

1. Cover latch
2. Main Wash section
3. Pre-Wash section

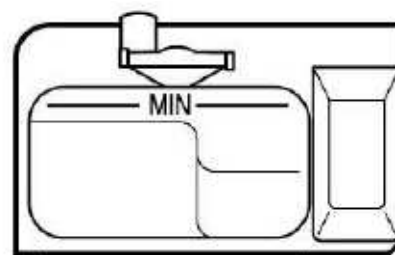
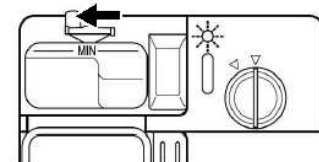

Haier**Built-In Dishwasher****Model: ESD300/ESD301/ESD302/310/311/312****4. Close the dispenser cover.**

It is normal for the cover to open partially when dispensing detergent.

NOTE: Use both sections for cycles with 2 washes . Use only the main wash section for cycles with 1 wash, See the "Cycle Selection Charts "for more details.

How much detergent to use

-Different brands of dishwasher detergent have different amounts of phosphorous for softening water .If you have hard water and use a detergent with a phosphorous content of less than 8.7%, you might need to use more detergent , or use a detergent with a phosphorous content higher than 8.7%.

-The amount of detergent to use depends on the hardness of your water and the type of detergent .If you use too little , dishes won't be clean . If you use too much in soft water glassware will etch.

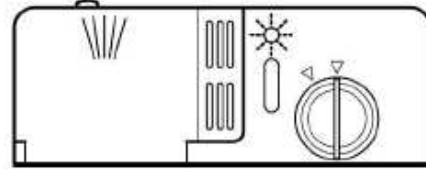
**10.3 Rinse Aid dispenser**

Rinse aids prevent water from forming droplets that can dry as spots or streaks . They also improve drying by allowing water to drain off of the dishes during the final rinse by releasing a small amount of the rinse aid into the rinse water. Your dishwasher is designed to use a liquid rinse aid. Do not use a solid or bar type.

Filling the dispenser

The rinse aid dispenser holds 4.8 oz(145ml) of rinse aid. Under normal conditions, this will last for about three months. Rinse aid is released through an opening in the dispenser. You do not to wait until the dispenser is empty to refill it. Try to keep it full, but be careful not to overflow it.

1. Make sure the dishwasher door is fully open.
2. Open the dispenser by pushing the cover latch.
3. Add rinse aid until the indicator window looks full.
4. Clean up any spilled rinse aid with a damp cloth.
5. Close the cover.

Rinse aid setting

The amount of rinse aid released into the final wash can be adjusted .The factory setting is at 3. For most water conditions. Set the adjuster to 2 or 3.If there are rings or calcium(hard water) spots on dishes , try a higher setting.

To adjust the setting

Open the dispenser cover .Turn the adjuster inside the dispenser to the desired setting .

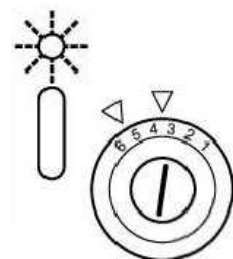
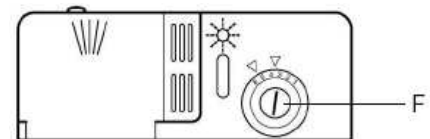
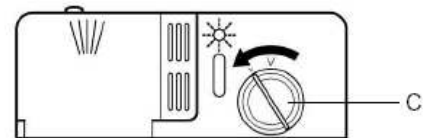
**10.4 Cycle Selection Charts**



Built-In Dishwasher

Model: ESD300/ESD301/ESD302/310/311/312

Select the wash cycle and options desired. The dishwasher starts filling once you press cycle, unless you select a delay wash. You can select an option as the machine is filling.

A "●" shows what steps are in each cycle.

Temperatures indicate where extra heat is added.

Water usage is shown in U.S. gallons/liters.

This model meets the ENERGY STAR® guidelines for energy efficiency.

Cycle time includes dry time. An asterisk (*) by the cycle time indicates the cycle time might be longer depending on the temperature of the water entering the dishwasher.



Anti-Bacterial
(On some models)

Use this cycle for all day-to-day soil types, including both normal and heavy soils, giving you exceptional cleaning performance combined with reassuring sanitization.



Use both detergent dispenser sections.

Pre-Wash	Main Wash	Rinse	Final Heated Rinse	Dry	Minimum Time(min)	Water Usage (gal/L)
● 130°F (55°)	● 150°F (66°)	●	● 160°F (71°)		39* (Light soil)	6.5-10/ 24-38



Pots & Pans

Use this cycle for hard-to-clean, baked-on, cookware and harder than normal water conditions.



Use both detergent dispenser sections.

Pre-Wash	First Wash	Second Wash	Main Wash	Rinse	Final Heated Rinse	Dry	Minimum Time(min)	Water Usage (gal/L)
●	●	●	● 140°F (60°)	●	●		68*	10/38



Normal
(On models without soil sensor)

Use this cycle for loads with normal amounts of food soil. (The energy-usage label is based on this cycle.)



Use both detergent dispenser sections.

Pre-Wash	Main Wash	Rinse	Final Heated Rinse	Dry	Minimum Time(min)	Water Usage (gal/L)
●	● 130°F (54°)	●	●		39*	6.5/24.5



Normal
(On some models with soil sensor)



Use this cycle for loads with normal amounts of food soil. (The energy-usage label is based on this cycle.)





Use both detergent dispenser sections.

Pre-Wash	Main Wash	Rinse	Final Heated Rinse	Dry	Minimum Time(min)	Water Usage (gal/L)
●	● 130°F (54°)		●		29* (Light soil)	





 Use this cycle for china and crystal. This cycle uses a light wash and gentle dry. During the heated dry, the heating element cycles on and off.
 
 Use main detergent dispenser section.



Rinse	Main Wash	Rinse	Final Heated Rinse	Dry	Minimum Time(min)	Water Usage (gal/L)
●	● 130°F (54*)		●		29*	4.9/18

 Use this cycle for china and crystal. This cycle uses a light wash and gentle dry. During the heated dry, the heating element cycles on and off.
 
 Use main detergent dispenser section.

Rinse	Main Wash	Rinse	Final Heated Rinse	Dry	Minimum Time(min)	Water Usage (gal/L)
●	● 130°F (54*)		●		29*	4.9/18

 Use this cycle for a quick wash and light dry to cleanup cookware prior to entertaining. The sensor adds water and time to the cycle, if needed, for maximum cleaning. This cycle uses a shortened dry time. Towel drying may be needed.
 
 Use main detergent dispenser section.

Pre-wash	Main Wash	Rinse	Final Heated Rinse	Dry	Minimum Time(min)	Water Usage (gal/L)
	●		●		19*	3.2/12

 Use this rinse cycle for rinsing dishes, glasses, and silverware that will not be washed right away.
 
 Do not use detergent with this cycle.

Pre-wash	Main Wash	Rinse	Final Heated Rinse	Dry	Time (min)	Water Usage (gal/L)
		●			12	1.6/6.1

* If the incoming water temperature is less than the recommended temperature or food soils are heavy, the cycle will automatically compensate by adding time, heat, and water as needed.

■NOTE:

The sensor in your dishwasher monitors the soil level. Cycle time and/or water usage can vary from the numbers above as the sensor adjusts the cycle for the best wash performance.

Haier**Built-In Dishwasher****Model: ESD300/ESD301/ESD302/310/311/312**

10.5 Canceling a cycle

Anytime during a cycle, press



If your dishwasher has a dual-digiplay, it shows



Your dishwasher starts a 2-minutes drain (if needed). **Let the dishwasher drain completely.** The light turns off after 2 minutes.

NOTE: If your dishwasher does not need draining, press CANCEL/Drain again the light turns off. Select a new cycle and options.

To stop the drain

You can press CANCEL again to stop the drain immediately. Remember to drain the dishwasher before starting a new cycle.

10.6 Changing a cycle

During the first fill of a cycle

1. Press a new cycle and/or options.
2. Check the detergent dispensers. They must be filled properly for the new cycle.

After the first fill of a cycle

1. Press



If your dishwasher has a dual-digit display, it shows



Your dishwasher starts a 2-minutes drain (if needed). Let the dishwasher drain completely. The light turns off after 2 minutes.

NOTE: If your dishwasher does not need draining, press CANCEL again the light turns off.

1. Check the detergent dispensers. They must be filled properly for the new cycle.
2. Press a new cycle and/or options.

10.6 Adding Items During a Cycle

Haier**Built-In Dishwasher****Model: ESD300/ESD301/ESD302/310/311/312**

You can add an item anytime before the main wash starts. Open the door and check the detergent dispenser. If the cover is still closed, you can add items.

TO add items

1. Carefully open the door slightly to stop the cycle. Wait for the spraying action to stop before opening the door.
2. Open the door. If the detergent dispenser cover is still closed, add the item.
3. Close the door firmly until it latches. The dishwasher resumes the cycle after about a 10 seconds pause.

10.7 Option Selections

You can customize your cycles by pressing an option. If you change your mind, press the option again to turn the option off. Select a different option if desired. You can cancel change an option anytime before selected option begins. For example, you can press an unheated drying option anytime before drying begins.

Hi-Temp Wash

Select this option to heat the water during parts of the cycle. Higher water temperatures help clean tough soils. Hi-Temp Wash, with the Pots & Pans, Normal raises the water temperature in the main wash. This option adds heat, water and wash time to a cycle.

NOTE: Hi-Temp Wash is an option with the Pots & Pans and Normal cycles. Always use Hi-Temp Wash if you have hard water. You can't change this option after the first filling.

NOTE: Anti-bacteria Wash automatically uses this option. Sanitize Rinse is an option with the Pots & Pans, Normal cycle. Only these sanitization cycles have been designed to meet the NSF/ANSI requirements. You can't change this option after the main wash complete. If you change this option, the remaining time displayed by LED will reduce/add 3 minutes.

Heated Dry

Select this option to dry dishes with heat. The dishes take longer to dry and some spotting can occur. For best drying, always use a liquid rinse aid. Some items (such as plastics) may need towel drying.

NOTE: Heated Dry is an option with Anti-bacteria Wash, Pots and Pans Wash, Normal and China cycles. If you change this option, the remaining time displayed by LED will add/reduce 25 minutes.

Sanitize Rinse

Select this option to raise the Water temperature in the final rinse approximately 160 F (71*). The Sanitize Rinse Option adds heat and time to the cycle. This high temperature rinse sanitizes your dishes and glassware in accordance with NSF/ANSI standard 184 for Residential Dishwashers. Certified residential dishwashers are not intended for licensed food establishments.

Child Lock(On ESD310/311/312 models)

Use Child Lock to prevent unintended use of the dishwasher. You can also use the Child Lock feature to prevent unintended cycle or option changes during a cycle. When Child Lock is lit, all buttons are disabled.

NOTE: The dishwasher door can be opened while the controls are locked.

To turn on the Lock

Press and hold heated dry button for 3 seconds. Child Lock glows.

If you press any pad while your dishwasher control is locked, the light flashes 3 times and selection is ignored.

To turn off the Lock

Press and hold Heated Dry button for 3 seconds. The light turns off.

Delay Start(On ESD310/311/312 models)

Select this option to run your dishwasher at a later time or during off-peak hours. You can add items to the load anytime during the delay countdown. After adding items, close the door firmly until it latches. The delay countdown will not continue if the door is not latched. You can delay the start of a cycle up to 12 hours. The first time you use Delay Start, you will see showing a 1-hour delay.

Haier**Built-In Dishwasher****Model: ESD300/ESD301/ESD302/310/311/312**

After the first time that you use delay, the control will start by calling up the last delay that you can. You can adjust from there if you want to change it.

To delay the start

- 1.Close the door.
- 2.Repeatedly press until you see the desired hours of delay in the display.
- 3.Select a wash cycle and options.

When the delay reaches 12 hours, the delay turns off. Press Delay Start again to select a new number of delay hours.

Plate Warmer

Use the Plate Warmer option to warm serving dishes or dinner plates.

Note: Do not use the option with cycles.

- 1.Open the door
- 2.Press plate warmer button, plate warmer glows.
- 3.Allow 8 minutes to heated the dishware.

10.7 Cycles Status Indicators

Follow the progress of your dishwasher with the Cycle Status indicators.

Water Heated(on ESD310/311/312 models)

Water Heated glows only when the cycle pauses to heat water to a set temperature .Washing or rinsing continues as water

heated. Once water reaches the set temperature, the light goes off and the cycle resumes.

Washing(on ESD310/311/312 models)

Washing glows during pre-wash and main wash periods.

Turbidity Sensor(on ESD310/311/312 models)

Turbidity Sensor glows during the sensing part of the cycle. Your dishwasher sense soil lever at the end of the Pre-Wash. Washing continues while Sensing occurs.

Rinsing(on ESD310/311/312 models)

Rinsing glows during rinse periods.

Drying(on ESD310/311/312 models)

Drying glows when the dishwasher is drying after the final rinse.

Clean

Clean glows when a wash cycle is complete. The light will remain ON until door is opened.

Sanitized

Sanitized glows when cycle has met sanitization condition. The light will remain ON until door is opened.

Add Rinse Aid (on ESD310/311/312 models)

Fill the Rinse Aid dispenser when Add Rinse Aid is lit. A rinse aid prevents water from forming droplets that dry as spots or streaks. If the Rinse Aid dispenser is empty, the light glows when you select a cycle or while a cycle is running.

11.Wash System

The five-level wash system provides excellent cleaning results. Three levels of filtration and a Soil collector system filter the wash water and prevent food

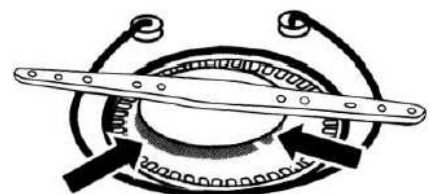

Haier**Built-In Dishwasher****Model: ESD300/ESD301/ESD302/310/311/312**

particles from redepositing on the clean dishes.

The wash water continuously flows through the filter, trapping food particles.

-Two water jets, located under the spray arm, remove the food particles from the filter.

-A coarse strainer prevents bones, pits, and other large objects from entering the pump system.

12. Drying System

During drying, you can see steam escaping through the vent at the upper left corner of the door. This is normal as the heat dries your dishes.

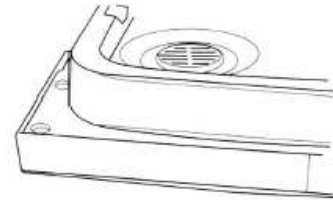

13. Overfill Protection Float

The over fill protection float (in the front right corner of the dishwasher tub) keeps the dishwasher from overflowing. It must be in place for the dishwasher to operate. Check under the float for objects that may keep the protector from moving up or down.

NOTE: Periodically check the coarse strainer and remove any objects on the strainer.

IMPORTANT: The vapor is hot. Do not touch the vent.



Haier**Built-In Dishwasher****Model: ESD300/ESD301/ESD302/310/311/312**

14. Washing special items and dishwasher care

WASHING SPECIAL ITEMS

If you have doubts about washing a particular item, check with the manufacturer to see if it is dishwasher safe.

Material	Dishwasher Safe?/Comments
Aluminum	Yes High water temperature and detergents can affect finish of anodized aluminum
Disposable Aluminum	No Do not wash throwaway aluminum pans in the dishwasher. These might shift during washing and transfer black marks to dishes and other items.
Bottles and cans	No Wash bottles and cans by hand. Labels attached with glue can loosen and clog the spray arms or pump and reduce washing performance.
Cast Iron	No Seasoning will be removed and iron will rust.
China / Stoneware	Yes Always check manufacturer's recommendations before washing. Antique, hand-painted, or over-the-glaze patterns may fade. Gold leaf Can discolor or fade.
Crystal	Yes Check manufacturer's recommendations before washing. Some types of leaded crystal can etch with repeated washing.
Gold	No Gold-colored flatware will discolor.
Glass	Yes Milk glass yellows with repeated dishwasher washing.
Hollow-Handle Knives	No Handles of some knives are attached to the blade with adhesives which can loosen if washed in the dishwasher
Pewter Brass, Bronze	No High water temperatures and detergent can discolor or pit the finish.
Disposable Plastics	No Cannot withstand high water temperatures and detergents.

To clean interior

Material	Dishwasher Safe?/Comments
Plastics	Yes Always check manufacturer's recommendations before washing. Plastics vary in their capacity to withstand high temperatures and detergents. Load plastics in top rack only.
Stainless Steel	Yes Run a rinse cycle if not washing immediately. Prolonged contact with food containing salt, vinegar, milk products, or fruit juice can damage finish.
Sterling Silver or Silver Plate	Yes Run a rinse cycle if not washing immediately. Prolonged contact with food containing salt, acid, or sulfide (eggs, mayonnaise, and seafood) can damage finish.
Tin	NO Can rust.
Wooden Ware	No Wash by hand. Always Check Manufacturer's instructions before washing. Untreated wood can warp, crack, or lose its finish.

DISHWASHER CARE

Cleaning

Cleaning the exterior

In most cases, regular use of a soft, damp cloth or sponge and a mild detergent is all that is necessary to keep the outside of your dishwasher looking nice and clean.



Cleaning the interior

Hard water minerals can cause a white film to build up on the inside surfaces, especially just beneath the door area.

Do not clean the dishwasher interior until it has cooled. Wear rubber gloves. Do not use any type of cleanser other than dishwasher detergent because it may cause foaming or sudsing.

Haier**Built-In Dishwasher****Model: ESD300/ESD301/ESD302/310/311/312**

Make a paste with powdered dishwasher detergent on a damp sponge and clean.

OR

Use liquid automatic dishwasher detergent and clean with a damp sponge.

OR

See the vinegar rinse procedure in "spotting and filming on dishes" in "Troubleshooting."

NOTE: Run a Normal cycle with detergent after cleaning the interior

15.Drain Air Gap

Check the drain air gap anytime your dishwasher isn't draining well.

Some state or local plumbing codes require the addition of a drain air gap between a built-in dishwasher and the home drain system. If a drain is clogged, the drain air gap protects your dishwasher from water backing up into it. The drain air gap is usually located on top of the sink or countertop near the dishwasher.

NOTE: The drain air gap is an external plumbing device that is not part of your dishwasher. The warranty provided with your dishwasher does not cover service costs directly associated with the cleaning or repair of the external drain air gap.

TO clean the drain air gap

Clean the drain air gap periodically to ensure proper drainage of your dishwasher. Follow the cleaning instructions provided by the manufacturer. With most types, you lift off the chrome cover. Unscrew the plastic cap. Then check for any soil buildup. Clean if necessary.

16.Storing

Storing for the Summer

Protect your dishwasher during the summer months by turning off the water supply and power supply to the dishwasher

Winterizing your dishwasher

Protect your dishwasher and home against water damage due to freezing water lines. If your dishwasher is left in a seasonal dwelling or could be exposed to near freezing temperatures, have your dishwasher winterized by authorized service personnel.

17.Function Schedule

1、 Anti-Bacterial wash(Heavy soil, On ESD310/311/312 models)

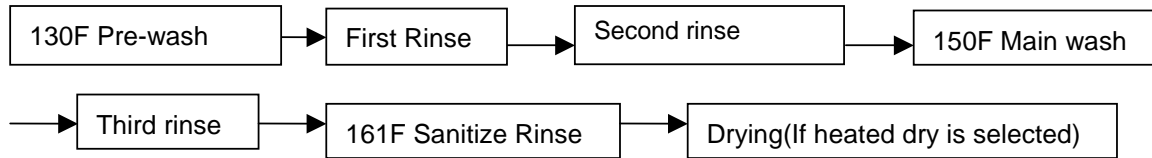

2、 Anti-Bacterial wash(Middle and light soil, On ESD310/311/312 models)



3、 Pots and Pans Wash

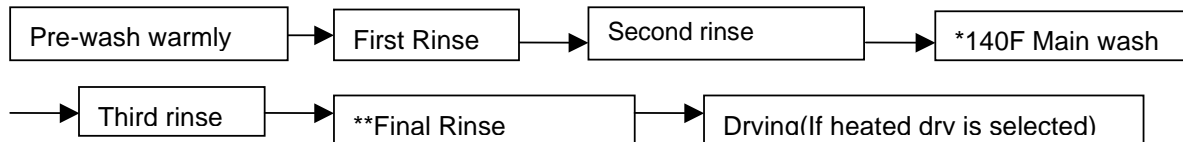

Notice:

*:The temp. should 150 F when selecting Hi-Temp Wash.

** :If user select Sanitize Rinse option, the dishwasher would heat water to 161F in this step.

4、 Heavy Wash(On ESD300/301/302 models)

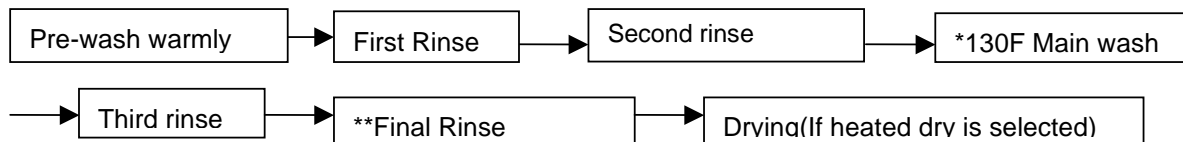

Notice:

*:The temp. should 140 F when selecting Hi-Temp Wash.

** :If user select Sanitize Rinse option, the dishwasher would heat water to 161F in this step.

5.Normal Wash(On ESD300/301/302 models)

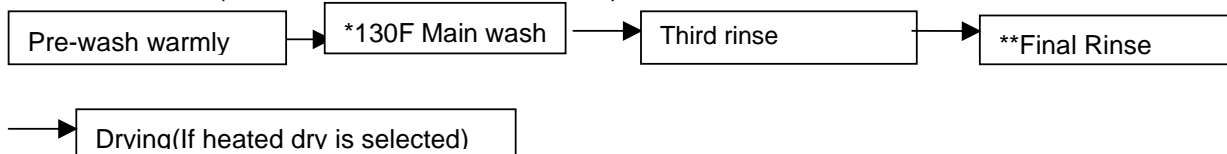

Notice:

*:The temp. should 140 F when selecting Hi-Temp Wash.

** :If user select Sanitize Rinse option, the dishwasher would heat water to 161F in this step.

6.Normal Wash(On ESD310/311/312 models, Heavy soil level)



Built-In Dishwasher

Model: ESD300/ESD301/ESD302/310/311/312

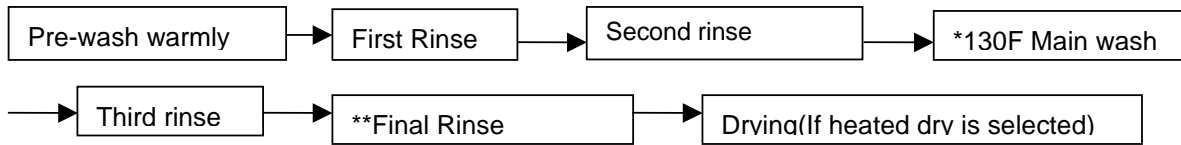

Notice:

*:The temp. Should 140 F when selecting Hi-Temp Wash.

**.:If user select Sanitize Rinse option, the dishwasher would heat water to 161F in this step.

7.Normal Wash (On ESD310/311/312 models, Middle soil level)

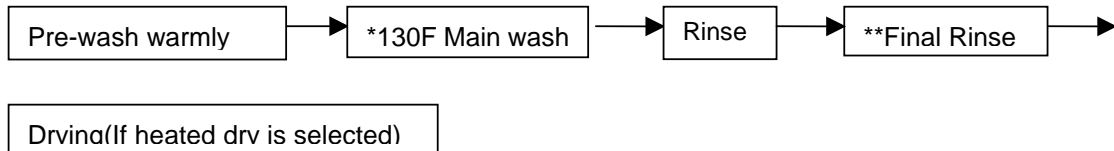

Notice:

*:The temp. Should 140 F when selecting Hi-Temp Wash.

**.:If user select Sanitize Rinse option, the dishwasher would heat water to 161F in this step.

8.Normal Wash (On ESD310/311/312 models, Light soil level)

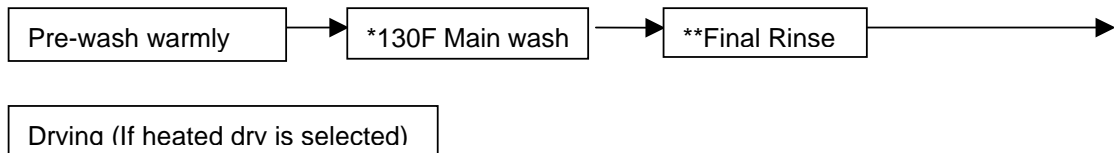

Notice:

*:The temp. Should 140 F when selecting Hi-Temp Wash.

**.:If user select Sanitize Rinse option, the dishwasher would heat water to 161F in this step.

9.Light/China Wash (On ESD310/311/312 models, Light soil level)

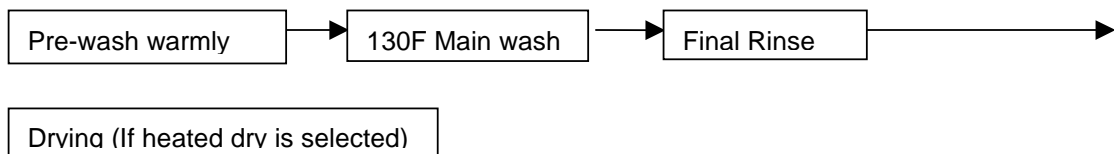

10.Light/China Wash

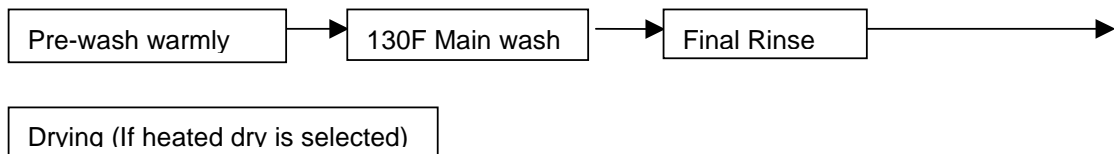

11.Quick Wash

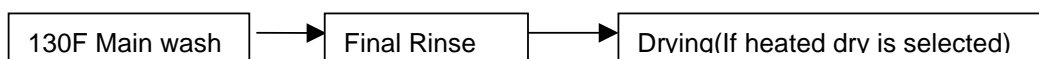

12.Rinse & Hold

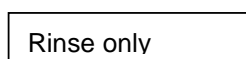



18.Maintenances Services and Trouble Shooting

ESD300/301/302

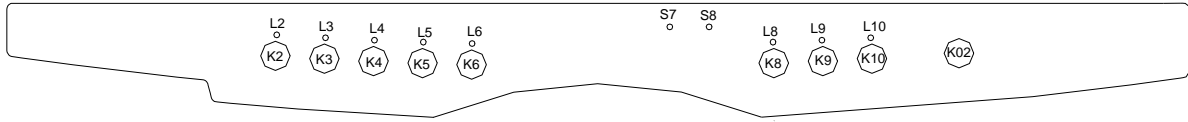

If the s7(Clean) and s8(Ssanitized) indicator flash at same time,the temperature sensor is fault.

ESD310/311/312

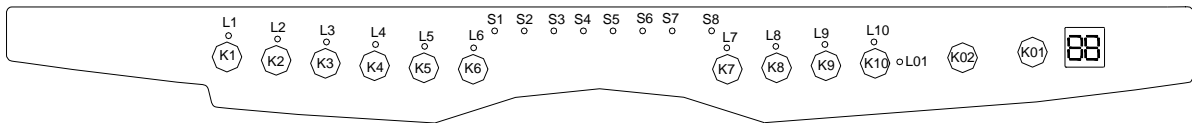

If the 2-digit 7-segment displayer display Er, it shown that the temperature sensor is fault.

Analysis of the common breakdowns.

Phenomenon: the cycle and option can not been selected

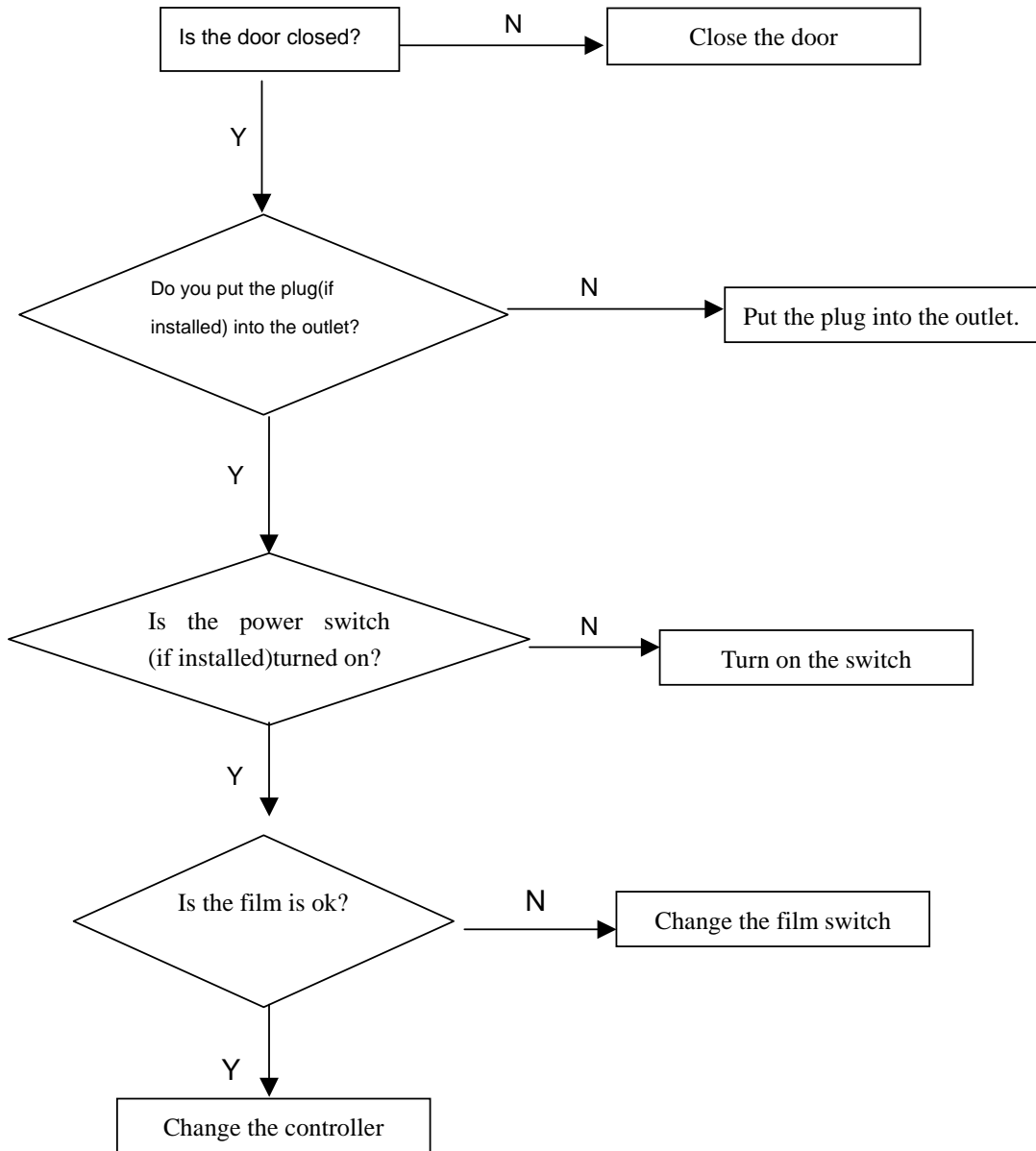

Phenomenon: the dishwasher is running properly without water in tub

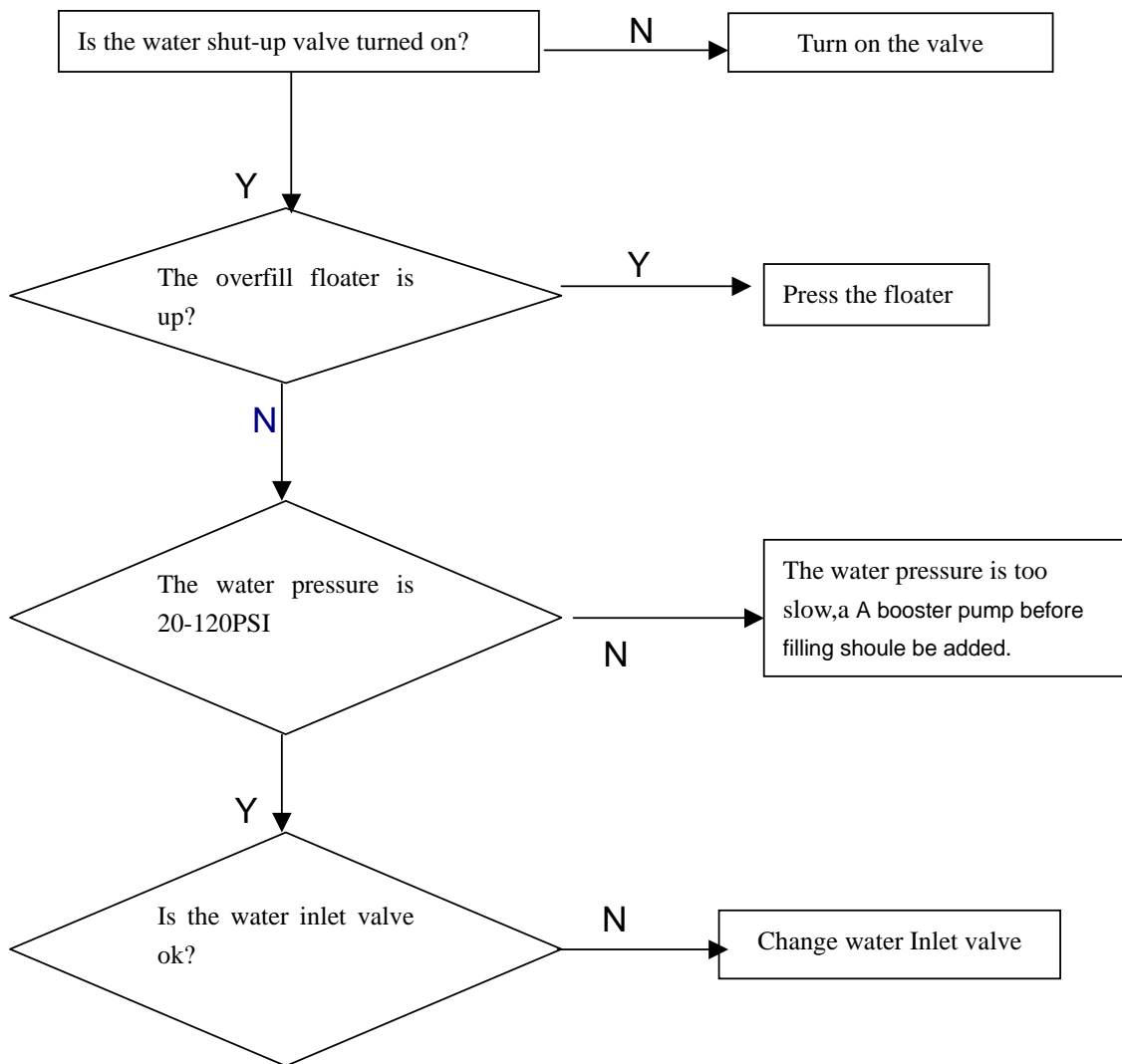



Heating trouble

Phenomenon: program controller stop turning

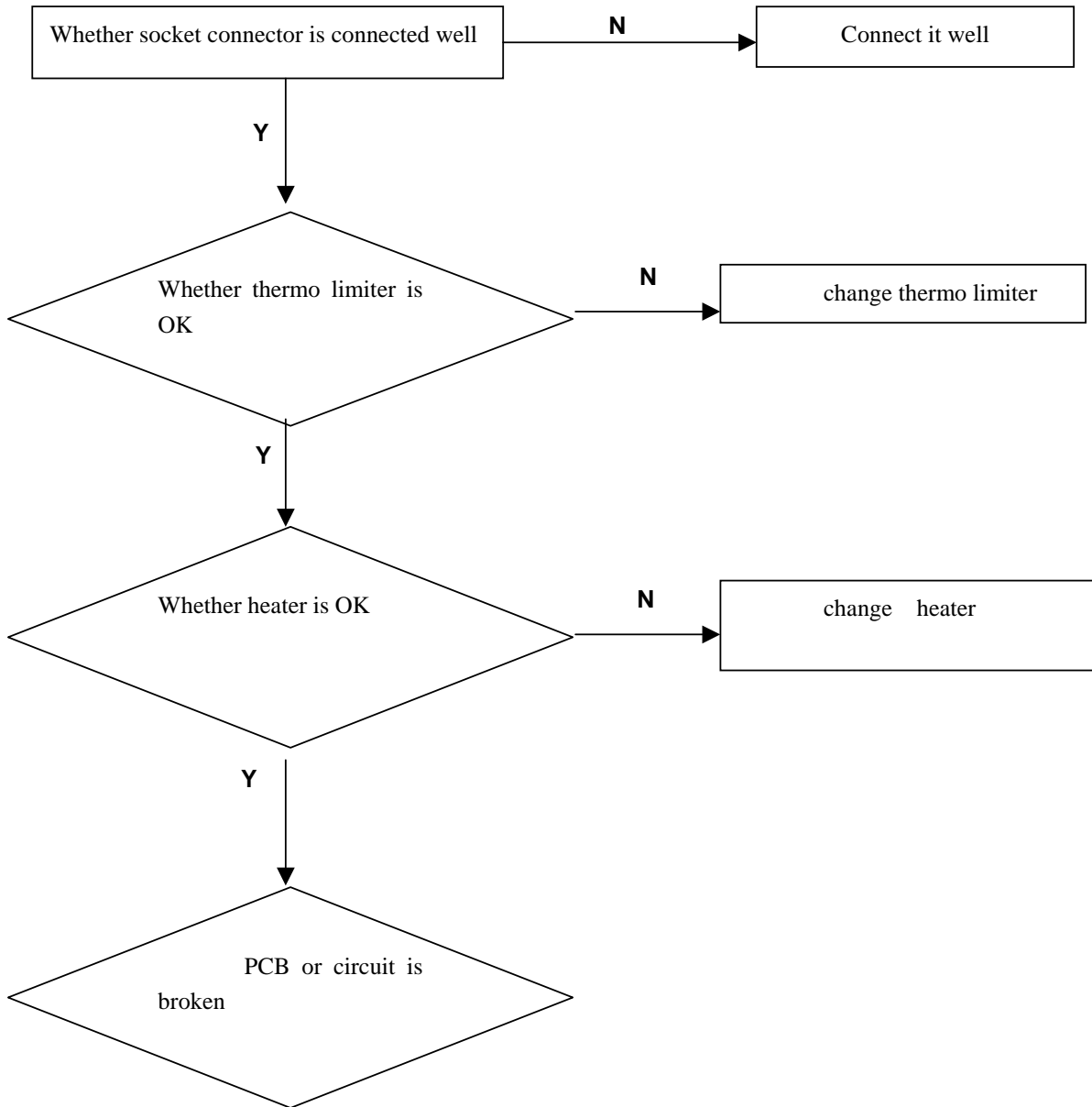

Power supply trouble

Phenomenon: dishwasher cannot work

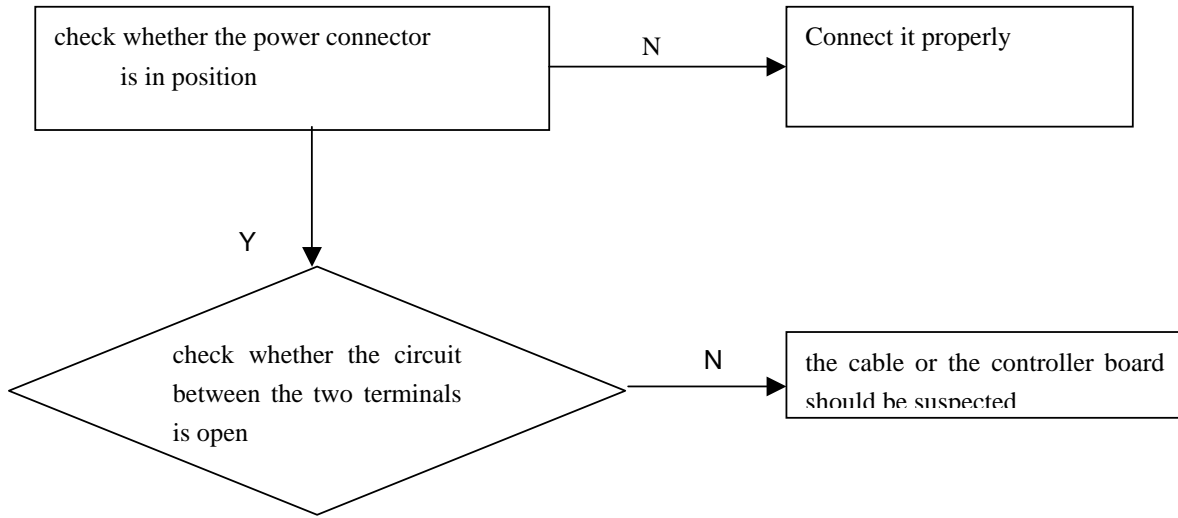



19.Circuit Diagram

ESD310/ESD311/ESD312 MODELS

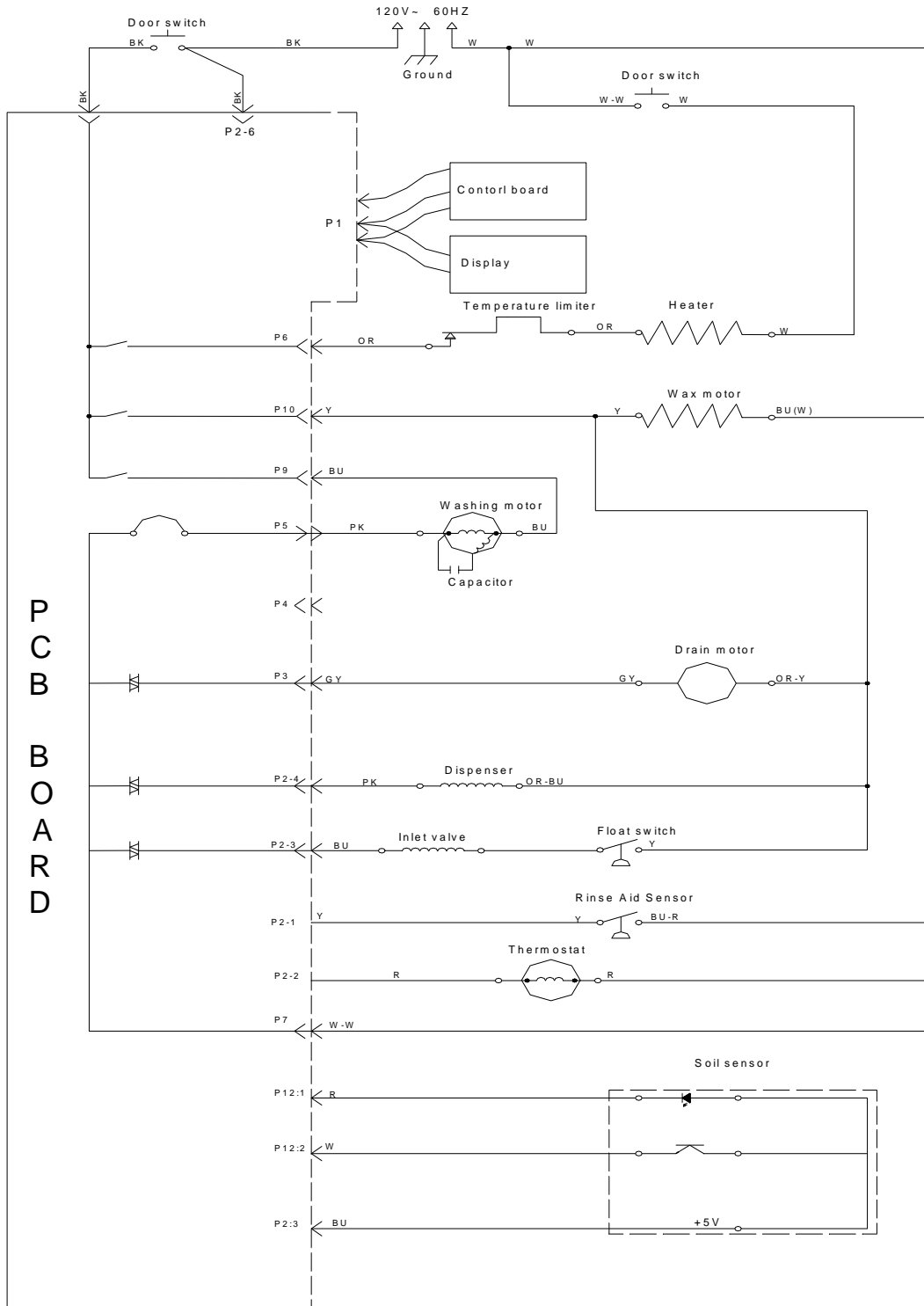

ESD300/ESD301/ESD302 MODELS

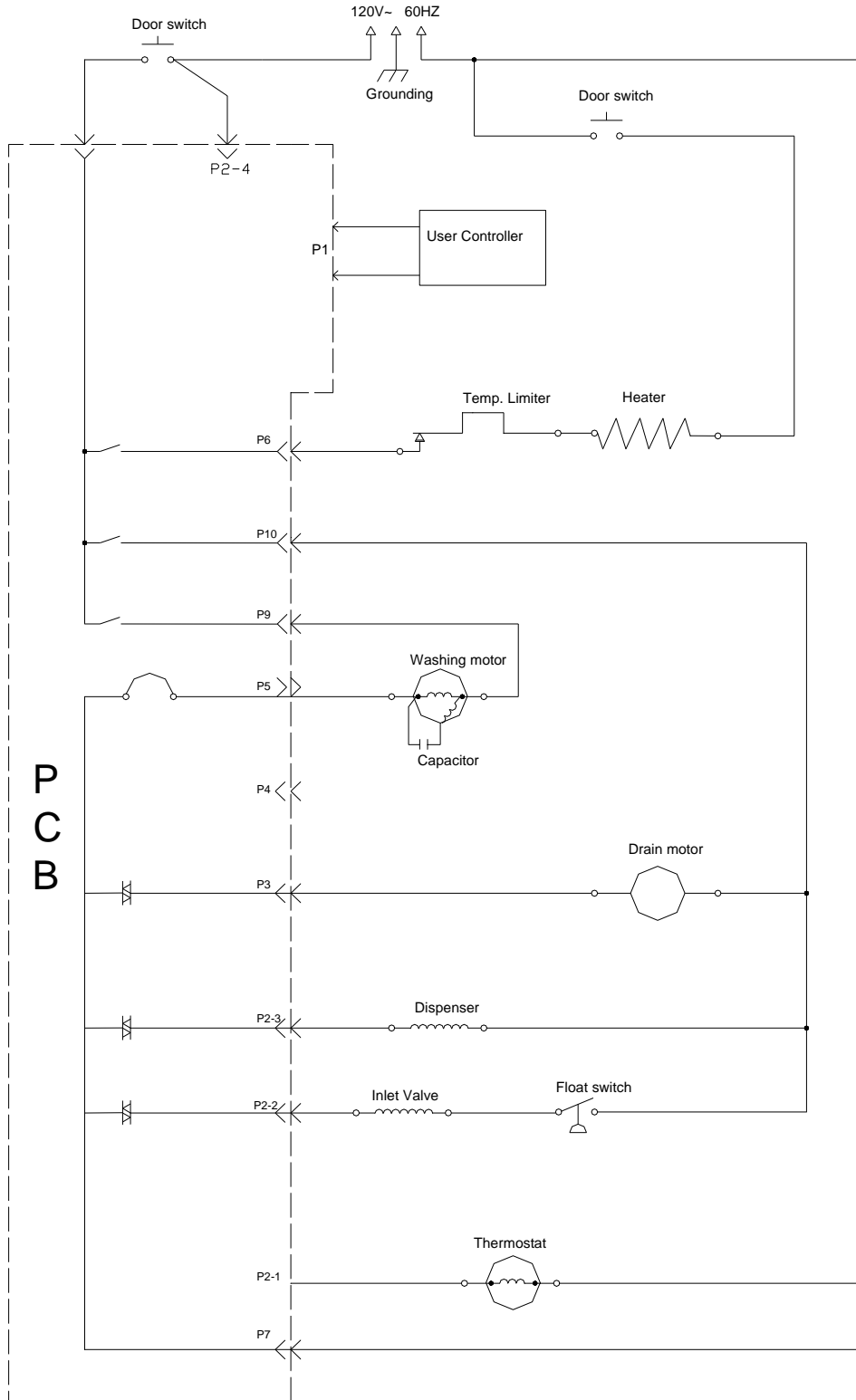

Sincere Forever