



Dishwashers

Safety Instructions 2, 3

Operating Instructions

Care and Cleaning 9-10

Control Panel and Settings 4-5

Loading the Racks 8

Using the Dishwasher 6-7

Troubleshooting Tips 11-12

Consumer Support

Consumer Support Back Cover

Warranty 15

Owner's Manual

GLDA690

GLDA696

Write the model and serial numbers here:

Model # _____

Serial # _____

You can find them on the tub wall just inside the door.

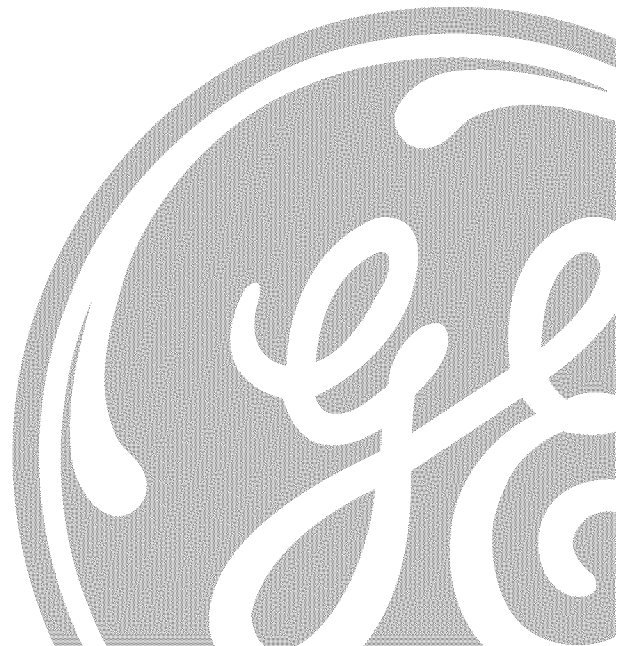

IMPORTANT SAFETY INFORMATION.

READ ALL INSTRUCTIONS BEFORE USING —

SAVE THESE INSTRUCTIONS

▲ WARNING!

For your safety, the information in this manual must be followed to minimize the risk of fire or explosion, electric shock, and to prevent property damage, personal injury, or death.



▲ WARNING! WATER HEATER SAFETY

Under certain conditions, hydrogen gas may be produced in a water heater that has not been used for two weeks or more. **HYDROGEN GAS IS EXPLOSIVE.**

If the hot water has not been used for two weeks or more, prevent the possibility of damage or injury by turning on all hot water faucets and allow them to run for several minutes. Do this before using any electrical appliance which is connected to the hot water system. This simple procedure will allow any built-up hydrogen gas to escape. Since the gas is flammable, do not smoke or use an open flame or appliance during this process.



PROPER INSTALLATION AND MAINTENANCE

This dishwasher must be properly installed and located in accordance with the Installation Instructions before it is used. If you did not receive an Installation Instructions sheet with your dishwasher, you can receive one by visiting our website at ge.com.

- Connect to a grounded metal, permanent wiring system; or run an equipment-grounding conductor with the circuit conductors and connect to the equipment-grounding terminal or lead of the appliance.
- Improper connection of the equipment-grounding conductor can result in a risk of electric shock. Check with a qualified electrician or service representative if you are in doubt whether the appliance is properly grounded.
- Dispose of discarded appliances and shipping or packing material properly.
- Do not attempt to repair or replace any part of your dishwasher unless it is specifically recommended in this manual. All other servicing should be referred to a qualified technician.
- To minimize the possibility of electric shock, disconnect this appliance from the power supply before attempting any maintenance.

NOTE: Turning the dishwasher off does not disconnect the appliance from the power supply. We recommend having a qualified technician service your appliance.

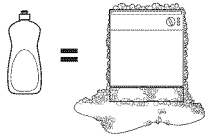
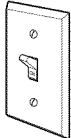

▲ CAUTION: To prevent minor injury or property damage

- Contents washed in Anti-bacterial mode, if available, may be hot to the touch. Use care before handling.
- Using a detergent that is not specifically designed for dishwashers will cause the dishwasher to fill with suds. 
- If your dishwasher is connected to a wall switch, ensure that the switch is on prior to use. 
- On dishwashers with electronic controls, if you choose to turn the wall switch off between wash cycles, allow 5-10 seconds after turning the switch on before touching START/RESET to allow the control to reboot.
- Non-Dishware Items: Do not wash items such as electronic air cleaner filters, furnace filters and paint brushes in your dishwasher. Damage to dishwasher and discoloration or staining of dishwasher may result.
- Close supervision is necessary if this appliance is used by or near children.
- Load light, plastic items so they will not become dislodged and drop to the bottom of the dishwasher—they might come into contact with the heating element and be damaged.

▲ **WARNING! RISK OF CHILD ENTRAPMENT** PROPER DISPOSAL OF THE DISHWASHER

Junked or abandoned dishwashers are dangerous... even if they will sit for "just a few days." If you are getting rid of your old dishwasher, please follow the instructions to help prevent accidents.

Before You Throw Away Your Old Dishwasher

Take off the door of the washing compartment or remove the door latch (as shown).

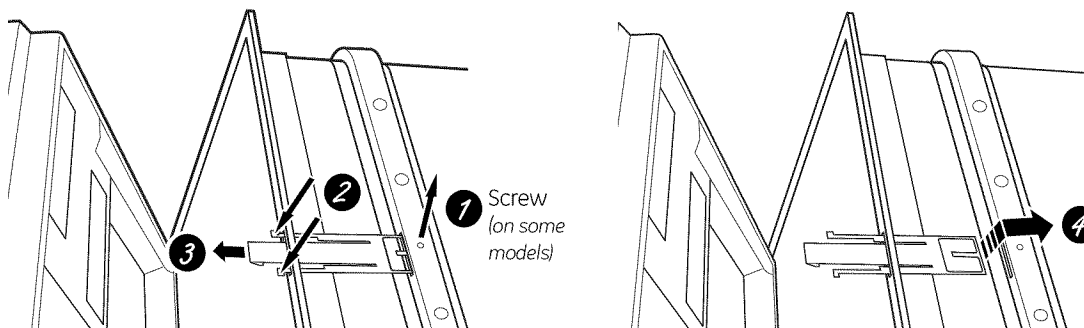

▲ **WARNING!**

When using your dishwasher, follow basic precautions, including the following:

- Use this appliance only for its intended purpose as described in this Owner's Manual.
- Use only powder, tabs, liquid detergents or rinse agents recommended for use in a dishwasher and keep them out of the reach of children. **Cascade®**, **Cascade® Complete** and **Electrasol®** Automatic Dishwashing Detergents, and **Jet-Dry®** and **Cascade Crystal Clear®** rinse agents have been approved for use in all GE dishwashers.
- **Do not mix any chlorine bleach-based automatic dishwashing detergent with any dishwashing detergent containing enzymes as this could cause the detergents to congeal and lead to blockage of the SmartDispense™ system.**
- Locate sharp items so that they are not likely to damage the door seal.
- Load sharp knives with the handles up to reduce the risk of cut-type injuries.
- Do not wash plastic items unless marked dishwasher safe or the equivalent. For plastic items not so marked, check the manufacturer's recommendations.
- Do not touch the heating element during or immediately after use.
- Do not operate your dishwasher unless all enclosure panels are properly in place.
- Do not tamper with controls.
- Do not abuse, sit on or stand on the door or dish rack of the dishwasher.
- Do not allow children to play around dishwasher when opening or closing door due to the possibility of small fingers being pinched in door.
- Do not discard a dishwasher without first removing the door of the washing compartment or the door latch.
- Do not store or use combustible materials, gasoline or other flammable vapors and liquids in the vicinity of this or any other appliance.
- Do not allow children to play with, on or inside this appliance or any discarded appliance.



READ AND FOLLOW THIS SAFETY INFORMATION CAREFULLY.

SAVE THESE INSTRUCTIONS

About the dishwasher control panel.

Throughout this manual, features and appearance may vary from your model.

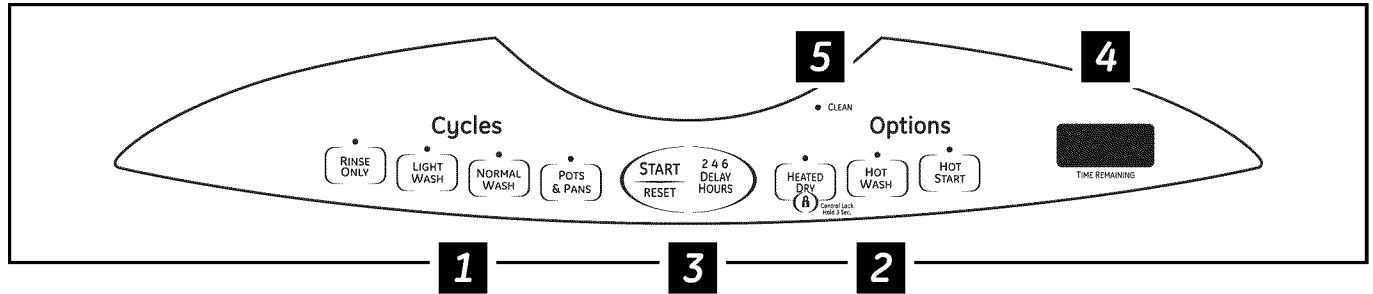

Control Settings

1 Wash Cycles

- POTS & PANS** 7.4 gal., 85 min.
This cycle is meant for heavily soiled dishes or cookware with dried-on or baked-on soils. This cycle may not remove burned-on foods. Everyday dishes are safe to be used in this cycle.
- NORMAL WASH** 5.3 gal., 56 min.
This cycle is for medium/heavily soiled dishes and glassware.
- LIGHT WASH** 4.2 gal., 33 min.
This cycle is for lightly soiled dishes and glassware.
- RINSE ONLY** 2.1 gal., 7 min.
This cycle is for rinsing partial loads that will be washed later.
DO NOT use detergent or HEATED DRY Option with this cycle.

2 Options

The light above the selected pad will be ON to indicate which OPTION has been selected.

- HEATED DRY** Turns the heater on for fast drying. This will extend the total cycle time by approximately 38 minutes for a **NORMAL WASH** cycle.
Light ON
NOTE: Cannot be selected with **RINSE ONLY** cycle.
- HEATED DRY** Shuts off the drying heat option. Dishes will air dry naturally to save energy.
Light OFF
- HOT WASH** When selected, the cycle will run a little longer with heated elements on to improve both wash and dry performance. Adds approximately 15 minutes to the cycle.
NOTE: Cannot be selected with **RINSE ONLY** cycle.
- HOT START** For use with heavily soiled and/or dried-on, baked-on soils. This option **MUST** be selected **PRIOR** to starting the cycle. This option adds approximately 22 minutes to the cycle and two additional rinses to the cycle.
NOTE: Cannot be selected with **RINSE ONLY** cycle.
- LOCK** You can lock the controls to prevent any selections from being made. Or you can lock the controls after you have started a cycle.

Children cannot accidentally start dishwasher by touching pads with this option selected.
To unlock the dishwasher controls, press and hold the **HEATED DRY** pad for 3 seconds. The light above the lock pad will turn off. To lock the dishwasher, press and hold the **HEATED DRY** pad for 3 seconds. The light above the **LOCK** pad will turn on.

3 Start/Reset

Close and latch the dishwasher door and select the cycle and desired enhancements. Touch the **START/RESET** pad to begin the cycle. The water fill begins immediately, and approximately 60 seconds later the wash action begins.

When the dishwasher door is fully closed and latched, the control panel lights will display the last settings you selected. If you don't want to change any of the settings, simply touch the **START/RESET** pad to begin the cycle.

If the door is closed, the indicator lights will turn off if the **START/RESET** pad is not selected within 5 minutes. To activate the display, open and close the door or press any pad.

DELAY HOURS You can delay the start of a wash cycle for up to 6 hours. Press the **DELAY START** pad to choose the number of hours you want to delay the start of the cycle; then press **START/RESET**.

The machine will count down and start automatically at the correct time.

NOTE: To cancel the **DELAY START** selection before the cycle begins, repeatedly press the **DELAY START** pad until the display is blank.

RESET To change a cycle after washing starts:

Touch the **START/RESET** pad to cancel the cycle. The **START/RESET** light will flash while the water is pumped out, if needed. This takes approximately 2 minutes.

4 Time Remaining Display *(on some models)*

During operation, the display shows the minutes remaining until the cycle is complete. The display may adjust the remaining time while the **SENSING** light is on. The time displayed at the start of each cycle may change from the factory setting as the unit customizes itself to home use. During a delay start, the display will show hours of time remaining until the cycle starts.

5 Clean

The **CLEAN** light is illuminated when the selected cycle and enhancements are complete. The light will stay **ON** until a pad is pressed or the door is opened and then closed.

Using the dishwasher.



Check the Water Temperature

The entering water should be at least 120°F and not more than 150°F, for effective cleaning and to prevent dish damage. Check the water temperature with a candy or meat thermometer. Turn on the hot

water faucet nearest the dishwasher, place the thermometer in a glass and let the water run continuously into the glass until the temperature stops rising.



Use Jet-Dry® or Cascade Crystal Clear® Rinse Agent

Jet-Dry® or **Cascade Crystal Clear®** rinse agents remove spots and prevent new film buildup on your dishes, glasses, flatware, cookware and plastic.

Filling the Dispenser

The rinse agent dispenser holds 3.5 oz. of rinse agent. Under normal conditions, this will last approximately one month. Refill when rinse agent is not visible in the indicator. Do not overfill.

- 1 Make sure the dishwasher door is fully open.
- 2 Turn the dispenser cap to the left and lift it out.
- 3 Add rinse agent until the indicator window looks full. Do not overfill.
- 4 Clean up any spilled rinse agent with a damp cloth to prevent foam.
- 5 Replace the dispenser cap.

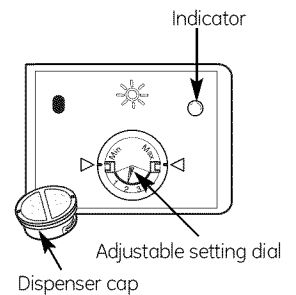

Rinse Aid Setting

The amount of rinse agent released into the final wash can be adjusted. The factory setting is at the midpoint. If there are rings of calcium (hard water) spots on dishes, try a higher setting. If you observe foam in the final rinse, try a lower setting.

To adjust the setting

Remove the dispenser cap, then turn the adjustable setting dial counterclockwise to increase the amount of rinse agent or clockwise to reduce the amount of rinse agent dispensed.

Dish Preparation Prior to Loading

- No pre-rinsing of normal food soil is required.
- Remove leafy vegetables, meat trimmings and excessive amounts of grease or oil.
- Remove acidic food soils that can discolor stainless steel.
- Scrape off hard soils, including bones, toothpicks, skins and seeds.
- Remove large quantities of any remaining food.



Proper Use of Detergent

Use only detergent specifically made for use in dishwashers. **Cascade®** and **Electrasol®** Automatic Dishwashing Detergents have been approved for use in all GE dishwashers. Keep your detergent fresh and dry. Don't put powder detergent into the dispenser until you're ready to wash dishes.

The amount of detergent to use depends on whether your water is *hard* or *soft*. With hard water, you need extra detergent. With soft water, you need less detergent.

Protect your dishes and dishwasher by contacting your water department and asking how hard your water is. Twelve or more grains is extremely hard water. A water softener is recommended. Without it, lime can build up in the water valve, which could stick while open and cause flooding. Too much detergent with soft water can cause a permanent cloudiness of glassware, called *etching*.

Use the information in the table below as a guideline to determine the amount of automatic dishwasher detergent to place in the dispenser.

Number of Grains	Detergent Cups to Fill
Less than 4	15 cup
4 to 8	25 cup
8 to 12	15 and 25 cups
Greater than 12	15, 25 cups and the open cup

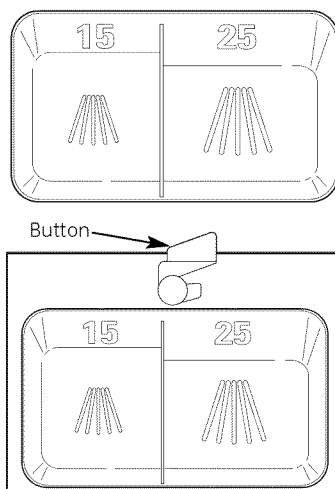

To open the wash cover, press the button and the cover will flip back.

For heavily-soiled loads, use the *Pots and Pans* or *Heavy Wash* cycle and add a little extra detergent.

DO NOT USE HAND DISH DETERGENT

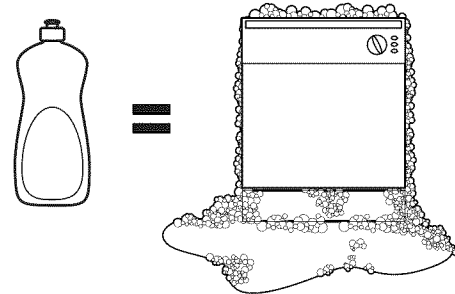

NOTE: Using a detergent that is not specifically designed for dishwashers will cause the dishwasher to fill with suds. During operation, these suds will spill out of the dishwasher vents, covering the kitchen floor and making the floor wet.

Because so many detergent containers look alike, store the dishwasher detergent in a separate space from all other cleaners. Show anyone who may use the dishwasher the correct detergent and where it is stored.

While there will be no lasting damage to the dishwasher, your dishes will not get clean using a dishwashing detergent that is not formulated to work with dishwashers.



Forget to Add a Dish?

A forgotten dish can be added any time before the main wash.

- 1 Squeeze the door latch to release the door.
- 2 Do not open the door until the water spray action stops. Steam may rise out of the dishwasher.

- 3 Add forgotten dishes.
- 4 Close the door.

Loading the dishwasher racks.

For best dishwashing results, follow these loading guidelines. Features and appearance of racks and silverware baskets may vary from your model.

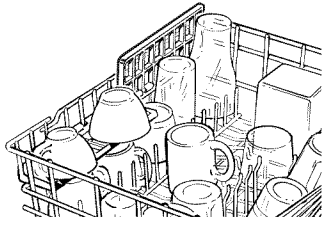

Upper Rack

Although the upper rack is for glasses, cups and saucers, pots and pans can be placed in this rack for effective cleaning. Cups and glasses fit best along the sides. This is also a secure place for dishwasher-safe plastics.

The upper rack is good for all kinds of odd-shaped utensils. Saucepans, mixing bowls and other items should be placed face down. Fold-down tines (on some models) provide flexibility for extra-large and hard-to-fit items.

Secure larger dishwasher-safe plastics over 2 tines when possible.

Make sure small plastic items are secure so they can't fall onto the heater.

Be sure that items do not protrude through the bottom of the rack and block rotation of the middle spray arm. This could result in poor wash performance for items in the upper rack.

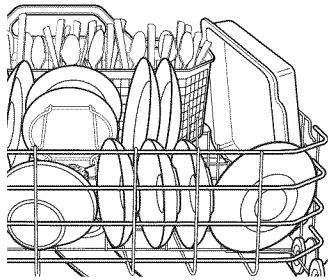

Lower Rack

The lower rack is best used for plates, saucers and cookware. Large items such as broiler pans and baking racks should go along the left-hand side. Load platters, pots and bowls along the sides, in corners or in the back. The soiled side of items should face the center of the rack. If necessary, oversized glasses and mugs can be placed in the lower rack to maximize loading flexibility.

Also, be careful not to let a portion of an item such as a pot or dish handle extend through the bottom rack. This could block the wash arm and cause poor washing results.

Fold-down tines (on some models) provide flexibility for extra-large and hard-to-fit items. The tines may be left in the up position or folded down to customize the lower rack.

Three-piece basket

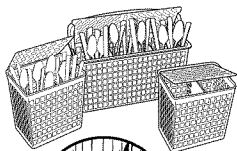

Don't let any item extend through bottom.

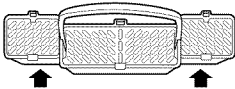

To remove end baskets, grasp the basket at opposite corners and slide apart.

Silverware Basket

To load flatware, simply push the adjustable handle to either side. Put flatware in the removable basket with fork and knife handles up to protect your hands. Place spoons in the basket with handles down. Mix knives, forks and spoons so they don't nest together. Distribute evenly. Small plastic items, such as measuring spoons and lids from small containers should go in the bottom of the silverware basket with the silverware on top.

A variety of options is available regarding the three-piece silverware basket in your dishwasher. The complete basket is designed to fit on the right side of the lower rack. Additionally, each end of the basket is removable to add loading flexibility to accommodate flatware and lower rack capacity needs.

The lids of both end and middle baskets (on some models) can be closed to contain small items. Long items can be placed on the utility shelf in the upper rack.

Cleaning the Exterior Door Panel

Before cleaning the front panel, make sure you know what type of panel you have. Refer to the last two letters of your model number. You can locate your model number on the left-hand tub wall just inside the door. If your model number ends with BB, WW or CC, then you have a Painted Door panel. If your model number ends with SS, then you have a Stainless Steel Door panel. If your model number ends with CS, then you have a CleanSteel Door panel.

Follow the instructions below for cleaning the door panel for your specific model.

Painted Door Panel (model numbers ending in BB–black, WW–white or CC–bisque)

Use a clean, soft, lightly dampened cloth, then dry thoroughly. You may also use a good appliance wax or polish.

Stainless Steel Door Panel (model numbers ending in SS)

The stainless steel panels can be cleaned with *Stainless Steel Magic* or a similar product using a clean, soft cloth. Do not use appliance wax, polish, bleach or products containing chlorine on Stainless Steel doors.

You can order *Stainless Steel Magic* #WX10X15 through GE Parts by calling 800.626.2002.

CleanSteel Door Panel (model numbers ending in CS)

Use a clean, soft, lightly dampened cloth, then dry thoroughly. Do not use appliance wax, polish or any chemical agent on CleanSteel doors.

Do not wipe the dishwasher with a soiled dish cloth or wet towel. These may leave a residue. Do not use scouring pads or powdered cleaners because these products can scratch the finish.

Cleaning the Control Panel

To clean the control panel, use a lightly dampened cloth. Then dry thoroughly.

Stainless Steel Interior—Tub and Inner Door

The stainless steel used to make the dishwasher tub and inner door provides the highest reliability available in a GE dishwasher. If the dishwasher tub or inner door should be scratched or dented during normal use, they will not rust or corrode. These surface blemishes will not affect their function or durability.

Caring for the dishwasher.

Spray Arms and Filters

The dishwasher will flush away all normal food soils. However, objects (fruit pits, bones, etc.) may collect in openings and should be removed occasionally to avoid clogging the drain system.

▲ CAUTION: *Personal injury hazard. Before cleaning the interior, wait at least 20 minutes after a cycle for the heating element to cool down. Failure to do so could result in burn injuries.*

Cleaning the Spray Arms

Because hard water chemicals will clog the spray arm jets and bearings, it is necessary to clean the spray arms regularly. To remove the spray arm, twist the retaining nut 90 degrees and pull the spray arm off the shaft.

Wash the arms in soapy, warm water and use a soft brush to clean the jets. Replace them after rinsing thoroughly.

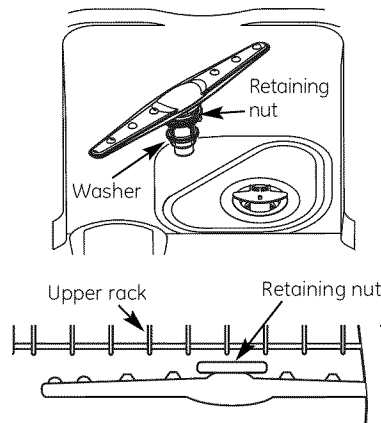

Cleaning the Filters

For best performance and results, the filter assembly must be cleaned regularly. The filter efficiently removes food particles from the wash water, allowing water to be recirculated during the cycle. For this reason, it is a good idea to remove the large food particles trapped in the filter frequently by rinsing the main filter and cup under running water. To remove the filter assembly, pull up on the cup handle. The entire filter assembly should be cleaned at least once a month. To clean the main filter and fine filter, use a cleaning brush. Then, reassemble the filter parts as shown in the illustration and reinsert the entire assembly in the dishwasher, positioning it in place and pressing downward. The dishwasher must never be used without the filters. Improper replacement of the filter may reduce the performance level of the appliance and may damage dishes and utensils.

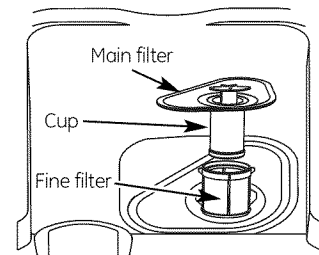

Protect Against Freezing

If your dishwasher is left in an unheated place during the winter, ask a service technician to:

- 1 Cut off electrical power to the dishwasher. Remove fuses or trip circuit breaker.
- 2 Turn off the water supply and disconnect the water inlet line from the water valve.

- 3 Drain water from the water inlet line and water valve. (Use a pan to catch the water.)
- 4 Reconnect the water inlet line to the water valve.

Does Your Dishwasher Have an Air Gap?

An air gap protects your dishwasher against water backing up into it if a drain clogs. The air gap is not a part of the dishwasher. It is not covered by your warranty. Not all plumbing codes require air gaps, so you may not have one.

The air gap is easy to clean.

- 1 Turn off the dishwasher and lift off the cover.
- 2 Remove the plastic cap and clean with a toothpick.

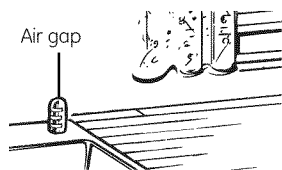

Check the air gap any time your dishwasher isn't draining well.

Before you call for service...

ge.com



Troubleshooting Tips
Save time and money! Review the charts on the following pages, or visit ge.com. You may not need to call for service.

Problem	Possible Causes	What To Do
Dishes and flatware not clean	Low inlet water temperature	<ul style="list-style-type: none"> Make sure inlet water temperature is correct (see page 6). Turn on the hot water faucet nearest the dishwasher, let run until the water temperature stops rising. Then start the dishwasher and turn off the faucet. This insures the entering water is hot.
	Water pressure is temporarily low	<ul style="list-style-type: none"> Turn on a faucet. Is water coming out more slowly than usual? If so, wait until pressure is normal before using your dishwasher.
	Air gap or disposer is clogged	<ul style="list-style-type: none"> Clean the air gap or flush the disposer.
	Improper rack loading	<ul style="list-style-type: none"> Make sure large dishware does not block the detergent dispenser or the wash arms. See the <i>Loading the dishwasher racks</i> section.
	No air gap or high drain loop	<ul style="list-style-type: none"> Verify that you have an air gap or a high drain loop. Refer to the Installation Instructions.
Spots and filming on glasses and flatware	Extremely hard water	<ul style="list-style-type: none"> Use <i>Jet-Dry</i>® or <i>Cascade Crystal Clear</i>® rinse agents to remove spots and prevent new film buildup.
	Low inlet water temperature Overloading the dishwasher Improper loading Old or damp powder detergent Rinse agent dispenser empty Too little detergent	<ul style="list-style-type: none"> To remove stubborn spots and pre-existing film from glassware: <ol style="list-style-type: none"> Remove all metal utensils from the dishwasher. Do not add detergent. Select the <i>POTS & PANS</i> cycle. Start the dishwasher and allow to run for 18 to 22 minutes. Dishwasher will now be in the main wash. Open the door and pour 2 cups (500 ml) of white vinegar into the bottom of the dishwasher. Close the door and allow to complete the cycle. If vinegar rinse doesn't work: Repeat as above, except use 1/4 cup (60 ml) of citric acid crystals instead of vinegar.
Cloudiness on glassware	Combination of soft water and too much detergent	<ul style="list-style-type: none"> This is called <i>etching</i> and is permanent. To prevent this from happening, use less detergent if you have soft water. Wash glassware in the shortest cycle that will get them clean.
	Water temperature entering the dishwasher exceeds 150°F	<ul style="list-style-type: none"> This could be etching. Lower the water heater temperature.
Suds in the tub	Correct detergent wasn't used	<ul style="list-style-type: none"> Use only automatic dishwasher detergents to avoid sudsing. <i>Cascade</i>® and <i>Electrasol</i>® Automatic Dishwashing Detergents have been approved for use in all GE dishwashers. To remove suds from the tub, open the dishwasher and let suds dissipate. Close and latch the dishwasher. Pump out water by touching the <i>START/RESET</i> pad once; then 30 seconds later, touch the <i>START/RESET</i> pad again. Repeat if necessary.
	Rinse agent was spilled	<ul style="list-style-type: none"> Always wipe up rinse agent spills immediately.

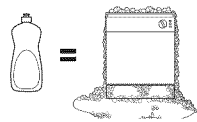

Safety Instructions

Operating Instructions

Troubleshooting Tips

Consumer Support

Before you call for service...

Problem	Possible Causes	What To Do
Detergent left in dispenser cups	Dishes are blocking the detergent cup	<ul style="list-style-type: none"> Reposition the dishes, so the water from the lower spray arm can flush the detergent cup. See the <i>Loading the dishwasher</i> section.
Black or gray marks on dishes	Aluminum utensils have rubbed against dishes	<ul style="list-style-type: none"> Remove marks with a mild, abrasive cleaner.
Dishes don't dry	Low inlet water temperature	<ul style="list-style-type: none"> Make sure inlet water temperature is at least 120°F. Select HEATED DRY. Use HOT START, HOT WASH or ADDED HEAT options. Select a higher cycle, such as POTS & PANS.
	Rinse agent dispenser is empty	<ul style="list-style-type: none"> Check the rinse agent dispenser and fill as required.
Control panel responded to inputs but dishwasher never filled with water	Door latch may not be properly seated	<ul style="list-style-type: none"> Make sure the door is firmly closed.
	Water valve may be turned off	<ul style="list-style-type: none"> Make sure water valve (usually located under the sink) is turned on.
Stained tub interior	Some tomato-based foods can cause reddish stains	<ul style="list-style-type: none"> Use of the RINSE ONLY cycle after adding the dish to the load can decrease the level of staining. GE recommends Cascade® Plastic Booster to help remove these types of stains.
	Tea or coffee stains	<ul style="list-style-type: none"> Remove the stain by hand, using a solution of 1/2 cup bleach and 3 cups warm water. <p>▲ WARNING Before cleaning interior, wait at least 20 minutes after a cycle for the heating elements to cool down. Failure to do so can result in burns.</p>
	An overall yellow or brown film can be caused by iron deposits in water	<ul style="list-style-type: none"> A special filter in the water supply line is the only way to correct this problem. Contact a water softener company.
	White film on inside surface—hard water minerals	<ul style="list-style-type: none"> GE recommends Jet-Dry® or Cascade Crystal Clear® to help prevent hard water mineral deposits from forming. Run dishwasher with citric acid to remove mineral deposits. Citric acid (Part number: WD35X151) can be ordered through GE Parts. See back cover for ordering information.
Dishwasher won't run	Fuse is blown or circuit breaker is tripped	<ul style="list-style-type: none"> Replace fuse or reset circuit breaker. Remove any other appliances from the circuit.
	Power is turned off	<ul style="list-style-type: none"> In some installations, the power to the dishwasher is provided through a wall switch, often located next to the disposer switch. Make sure it is on.
	Control panel is locked	<ul style="list-style-type: none"> Unlock control panel. See page 4.
	Reboot your control	<ul style="list-style-type: none"> Turn off power to the dishwasher (circuit breaker or wall switch) for 30 seconds; then turn back on.
Control panel lights go off when you're setting controls	Time too long between touching of selected pads	<ul style="list-style-type: none"> Each pad must be touched within 30 seconds of the others. To relight, touch any pad again, or unlock and relatch door.
Water standing in the bottom of the tub	This is normal	<ul style="list-style-type: none"> A small amount of clean water around the outlet on the tub bottom at the back of the tub keeps the water seal lubricated.
Water won't pump out of the tub	Drain is clogged	<ul style="list-style-type: none"> If you have an air gap, clean it. See page 10. If the dishwasher drains into a disposer, run disposer clear. Check to see if your kitchen sink is draining well. If not, you may need a plumber.
Steam	This is normal	<ul style="list-style-type: none"> Warm, moist air comes through the vent by the door latch during drying and when water is being pumped out. This is necessary for drying.
Sanitized light does not illuminate at the end of the cycle (Anti-Bacteria cycle only)	The door was opened and the cycle was interrupted during or after the main wash portion	<ul style="list-style-type: none"> Do not interrupt the cycle anytime during or after main wash.
	The incoming water temperature was too low	<ul style="list-style-type: none"> Raise the water heater temperature to between 120°F and 140°F.
Noise	Normal operating sounds	<ul style="list-style-type: none"> Detergent cup opening. Water entering dishwasher. The motor stops and starts at various times during the cycle. Drain pump sounds during the pump out.
	Rattling dishes when the spray arm rotates	<ul style="list-style-type: none"> Make sure dishes are properly loaded. See the <i>Loading the dishwasher racks</i> section.

Notes.

<i>Safety Instructions</i>	<i>Operating Instructions</i>	<i>Troubleshooting Tips</i>	<i>Consumer Support</i>
----------------------------	-------------------------------	-----------------------------	-------------------------

Notes.

Safety Instructions

Operating Instructions

Troubleshooting Tips

Consumer Support

GE Dishwasher Warranty.



All warranty service provided by our Factory Service Centers, or an authorized Customer Care[®] technician. To schedule service, on-line, 24 hours a day, visit us at ge.com, or call 800.GE.CARES (800.432.2737). Please have serial number and model number available when calling for service.

Staple your receipt here.
Proof of the original purchase date is needed to obtain service under the warranty.

For The Period Of: GE Will Replace:

One Year

From the date of the original purchase

Any part of the dishwasher which fails due to a defect in materials or workmanship. During this **limited one-year warranty**, GE will also provide, **free of charge**, all labor and related service to replace the defective part.

What GE Will Not Cover:

- Service trips to your home to teach you how to use the product.
- Improper installation, delivery or maintenance.
- Failure of the product if it is abused, misused, or used for other than the intended purpose or used commercially.
- Replacement of house fuses or resetting of circuit breakers.
- Damage to the product caused by accident, fire, floods or acts of God.
- Incidental or consequential damage caused by possible defects with this appliance.
- Cleaning or servicing of the air gap device in the drain line.
- Damage caused after delivery.
- Product not accessible to provide required service.

EXCLUSION OF IMPLIED WARRANTIES—Your sole and exclusive remedy is product repair as provided in this Limited Warranty. Any implied warranties, including the implied warranties of merchantability or fitness for a particular purpose, are limited to one year or the shortest period allowed by law.

This warranty is extended to the original purchaser and any succeeding owner for products purchased for home use within the USA. If the product is located in an area where service by a GE Authorized Servicer is not available, you may be responsible for a trip charge or you may be required to bring the product to an Authorized GE Service location for service. Proof of original purchase date is needed to obtain service under the warranty. In Alaska, the warranty excludes the cost of shipping or service calls to your home.

Some states do not allow the exclusion or limitation of incidental or consequential damages. This warranty gives you specific legal rights, and you may also have other rights which vary from state to state. To know what your legal rights are, consult your local or state consumer affairs office or your state's Attorney General.

Warrantor: General Electric Company. Louisville, KY 40225

Consumer Support.



GE Appliances Website

ge.com

Have a question or need assistance with your appliance? Try the GE Appliances Website 24 hours a day, any day of the year! For greater convenience and faster service, you can now download Owner's Manuals, order parts or even schedule service on-line.

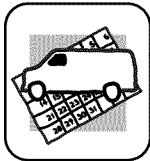

Schedule Service

ge.com

Expert GE repair service is only one step away from your door. Get on-line and schedule your service at your convenience 24 hours any day of the year! Or call 800.GE.CARES (800.432.2737) during normal business hours.

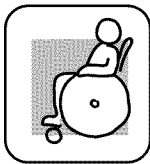

Real Life Design Studio

ge.com

GE supports the Universal Design concept—products, services and environments that can be used by people of all ages, sizes and capabilities. We recognize the need to design for a wide range of physical and mental abilities and impairments. For details of GE's Universal Design applications, including kitchen design ideas for people with disabilities, check out our Website today. For the hearing impaired, please call 800.TDD.GEAC (800.833.4322).



Extended Warranties

ge.com

Purchase a GE extended warranty and learn about special discounts that are available while your warranty is still in effect. You can purchase it on-line anytime, or call 800.626.2224 during normal business hours. GE Consumer Home Services will still be there after your warranty expires.

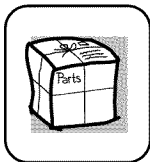

Parts and Accessories

ge.com

Individuals qualified to service their own appliances can have parts or accessories sent directly to their homes (VISA, MasterCard and Discover cards are accepted). Order on-line today, 24 hours every day or by phone at 800.626.2002 during normal business hours.

Instructions contained in this manual cover procedures to be performed by any user. Other servicing generally should be referred to qualified service personnel. Caution must be exercised, since improper servicing may cause unsafe operation.



Contact Us

ge.com

If you are not satisfied with the service you receive from GE, contact us on our Website with all the details including your phone number, or write to:

General Manager, Customer Relations
GE Appliances, Appliance Park
Louisville, KY 40225



Register Your Appliance

ge.com

Register your new appliance on-line—at your convenience! Timely product registration will allow for enhanced communication and prompt service under the terms of your warranty, should the need arise. You may also mail in the pre-printed registration card included in the packing material, or detach and use the form in this Owner's Manual.



Printed in the United States
Printed on Recycled Paper



Dishwashers

Safety Instructions 2, 3

Operating Instructions

Care and Cleaning 9-10

Control Panel and Settings 4-5

Loading the Racks 8

Using the Dishwasher 6-7

Troubleshooting Tips 11-12

Consumer Support

Consumer Support Back Cover

Warranty 15

Owner's Manual

GLDA690

GLDA696

Write the model and serial numbers here:

Model # _____

Serial # _____

You can find them on the tub wall just inside the door.

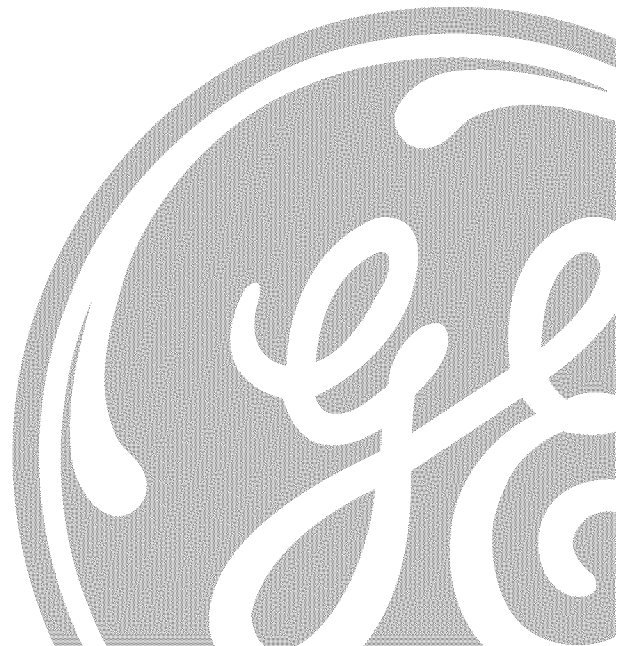

IMPORTANT SAFETY INFORMATION.

READ ALL INSTRUCTIONS BEFORE USING —

SAVE THESE INSTRUCTIONS

▲ WARNING!

For your safety, the information in this manual must be followed to minimize the risk of fire or explosion, electric shock, and to prevent property damage, personal injury, or death.



▲ WARNING! WATER HEATER SAFETY

Under certain conditions, hydrogen gas may be produced in a water heater that has not been used for two weeks or more. **HYDROGEN GAS IS EXPLOSIVE.**

If the hot water has not been used for two weeks or more, prevent the possibility of damage or injury by turning on all hot water faucets and allow them to run for several minutes. Do this before using any electrical appliance which is connected to the hot water system. This simple procedure will allow any built-up hydrogen gas to escape. Since the gas is flammable, do not smoke or use an open flame or appliance during this process.



PROPER INSTALLATION AND MAINTENANCE

This dishwasher must be properly installed and located in accordance with the Installation Instructions before it is used. If you did not receive an Installation Instructions sheet with your dishwasher, you can receive one by visiting our website at ge.com.

- Connect to a grounded metal, permanent wiring system; or run an equipment-grounding conductor with the circuit conductors and connect to the equipment-grounding terminal or lead of the appliance.
- Improper connection of the equipment-grounding conductor can result in a risk of electric shock. Check with a qualified electrician or service representative if you are in doubt whether the appliance is properly grounded.
- Dispose of discarded appliances and shipping or packing material properly.
- Do not attempt to repair or replace any part of your dishwasher unless it is specifically recommended in this manual. All other servicing should be referred to a qualified technician.
- To minimize the possibility of electric shock, disconnect this appliance from the power supply before attempting any maintenance.

NOTE: Turning the dishwasher off does not disconnect the appliance from the power supply. We recommend having a qualified technician service your appliance.

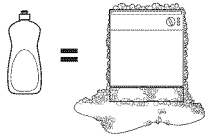
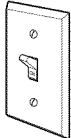

▲ CAUTION: To prevent minor injury or property damage

- Contents washed in Anti-bacterial mode, if available, may be hot to the touch. Use care before handling.
- Using a detergent that is not specifically designed for dishwashers will cause the dishwasher to fill with suds. 
- If your dishwasher is connected to a wall switch, ensure that the switch is on prior to use. 
- On dishwashers with electronic controls, if you choose to turn the wall switch off between wash cycles, allow 5-10 seconds after turning the switch on before touching START/RESET to allow the control to reboot.
- Non-Dishware Items: Do not wash items such as electronic air cleaner filters, furnace filters and paint brushes in your dishwasher. Damage to dishwasher and discoloration or staining of dishwasher may result.
- Close supervision is necessary if this appliance is used by or near children.
- Load light, plastic items so they will not become dislodged and drop to the bottom of the dishwasher—they might come into contact with the heating element and be damaged.

▲ **WARNING! RISK OF CHILD ENTRAPMENT** **PROPER DISPOSAL OF THE DISHWASHER**

Junked or abandoned dishwashers are dangerous... even if they will sit for "just a few days." If you are getting rid of your old dishwasher, please follow the instructions to help prevent accidents.

Before You Throw Away Your Old Dishwasher

Take off the door of the washing compartment or remove the door latch (as shown).

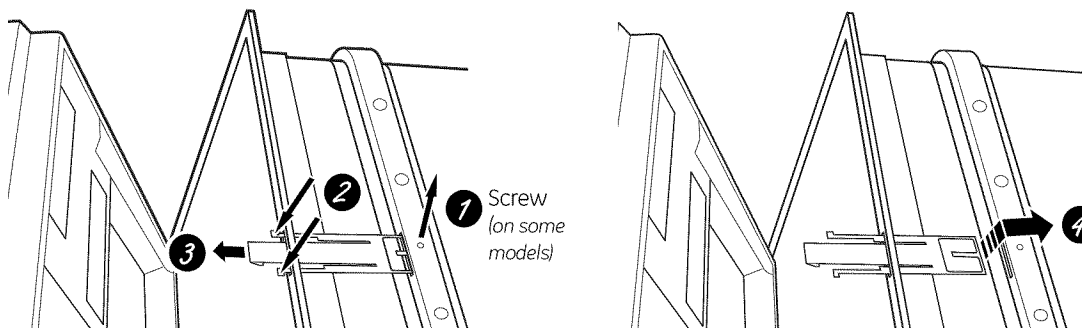

▲ **WARNING!**

When using your dishwasher, follow basic precautions, including the following:

- Use this appliance only for its intended purpose as described in this Owner's Manual.
- Use only powder, tabs, liquid detergents or rinse agents recommended for use in a dishwasher and keep them out of the reach of children. **Cascade®**, **Cascade® Complete** and **Electrasol®** Automatic Dishwashing Detergents, and **Jet-Dry®** and **Cascade Crystal Clear®** rinse agents have been approved for use in all GE dishwashers.
- **Do not mix any chlorine bleach-based automatic dishwashing detergent with any dishwashing detergent containing enzymes as this could cause the detergents to congeal and lead to blockage of the SmartDispense™ system.**
- Locate sharp items so that they are not likely to damage the door seal.
- Load sharp knives with the handles up to reduce the risk of cut-type injuries.
- Do not wash plastic items unless marked dishwasher safe or the equivalent. For plastic items not so marked, check the manufacturer's recommendations.
- Do not touch the heating element during or immediately after use.
- Do not operate your dishwasher unless all enclosure panels are properly in place.
- Do not tamper with controls.
- Do not abuse, sit on or stand on the door or dish rack of the dishwasher.
- Do not allow children to play around dishwasher when opening or closing door due to the possibility of small fingers being pinched in door.
- Do not discard a dishwasher without first removing the door of the washing compartment or the door latch.
- Do not store or use combustible materials, gasoline or other flammable vapors and liquids in the vicinity of this or any other appliance.
- Do not allow children to play with, on or inside this appliance or any discarded appliance.



READ AND FOLLOW THIS SAFETY INFORMATION CAREFULLY.

SAVE THESE INSTRUCTIONS

About the dishwasher control panel.

Throughout this manual, features and appearance may vary from your model.

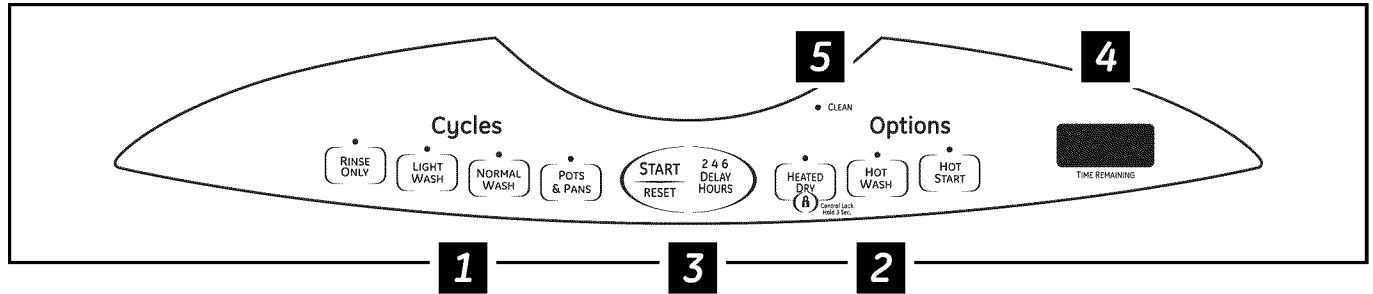

Control Settings

1 Wash Cycles

- | | |
|------------------------|---|
| POTS & PANS | 7.4 gal., 85 min.
This cycle is meant for heavily soiled dishes or cookware with dried-on or baked-on soils. This cycle may not remove burned-on foods. Everyday dishes are safe to be used in this cycle. |
| NORMAL WASH | 5.3 gal., 56 min.
This cycle is for medium/heavily soiled dishes and glassware. |
| LIGHT WASH | 4.2 gal., 33 min.
This cycle is for lightly soiled dishes and glassware. |
| RINSE ONLY | 2.1 gal., 7 min.
This cycle is for rinsing partial loads that will be washed later.
DO NOT use detergent or HEATED DRY Option with this cycle. |

2 Options

The light above the selected pad will be ON to indicate which OPTION has been selected.

- | | |
|--|---|
| HEATED DRY
Light ON | Turns the heater on for fast drying. This will extend the total cycle time by approximately 38 minutes for a NORMAL WASH cycle.
NOTE: Cannot be selected with RINSE ONLY cycle. |
| HEATED DRY
Light OFF | Shuts off the drying heat option. Dishes will air dry naturally to save energy. |
| HOT WASH | When selected, the cycle will run a little longer with heated elements on to improve both wash and dry performance. Adds approximately 15 minutes to the cycle.
NOTE: Cannot be selected with RINSE ONLY cycle. |
| HOT START | For use with heavily soiled and/or dried-on, baked-on soils. This option MUST be selected PRIOR to starting the cycle. This option adds approximately 22 minutes to the cycle and two additional rinses to the cycle.
NOTE: Cannot be selected with RINSE ONLY cycle. |
| LOCK
 | You can lock the controls to prevent any selections from being made. Or you can lock the controls after you have started a cycle.
Children cannot accidentally start dishwasher by touching pads with this option selected.
To unlock the dishwasher controls, press and hold the HEATED DRY pad for 3 seconds. The light above the lock pad will turn off. To lock the dishwasher, press and hold the HEATED DRY pad for 3 seconds. The light above the LOCK pad will turn on. |

3 Start/Reset

Close and latch the dishwasher door and select the cycle and desired enhancements. Touch the **START/RESET** pad to begin the cycle. The water fill begins immediately, and approximately 60 seconds later the wash action begins.

When the dishwasher door is fully closed and latched, the control panel lights will display the last settings you selected. If you don't want to change any of the settings, simply touch the **START/RESET** pad to begin the cycle.

If the door is closed, the indicator lights will turn off if the **START/RESET** pad is not selected within 5 minutes. To activate the display, open and close the door or press any pad.

DELAY HOURS You can delay the start of a wash cycle for up to 6 hours. Press the **DELAY START** pad to choose the number of hours you want to delay the start of the cycle; then press **START/RESET**.

The machine will count down and start automatically at the correct time.

NOTE: To cancel the **DELAY START** selection before the cycle begins, repeatedly press the **DELAY START** pad until the display is blank.

RESET To change a cycle after washing starts:

Touch the **START/RESET** pad to cancel the cycle. The **START/RESET** light will flash while the water is pumped out, if needed. This takes approximately 2 minutes.

4 Time Remaining Display *(on some models)*

During operation, the display shows the minutes remaining until the cycle is complete. The display may adjust the remaining time while the **SENSING** light is on. The time displayed at the start of each cycle may change from the factory setting as the unit customizes itself to home use. During a delay start, the display will show hours of time remaining until the cycle starts.

5 Clean

The **CLEAN** light is illuminated when the selected cycle and enhancements are complete. The light will stay **ON** until a pad is pressed or the door is opened and then closed.

Using the dishwasher.



Check the Water Temperature

The entering water should be at least 120°F and not more than 150°F, for effective cleaning and to prevent dish damage. Check the water temperature with a candy or meat thermometer. Turn on the hot

water faucet nearest the dishwasher, place the thermometer in a glass and let the water run continuously into the glass until the temperature stops rising.



Use Jet-Dry® or Cascade Crystal Clear® Rinse Agent

Jet-Dry® or **Cascade Crystal Clear®** rinse agents remove spots and prevent new film buildup on your dishes, glasses, flatware, cookware and plastic.

Filling the Dispenser

The rinse agent dispenser holds 3.5 oz. of rinse agent. Under normal conditions, this will last approximately one month. Refill when rinse agent is not visible in the indicator. Do not overfill.

- 1 Make sure the dishwasher door is fully open.
- 2 Turn the dispenser cap to the left and lift it out.
- 3 Add rinse agent until the indicator window looks full. Do not overfill.
- 4 Clean up any spilled rinse agent with a damp cloth to prevent foam.
- 5 Replace the dispenser cap.

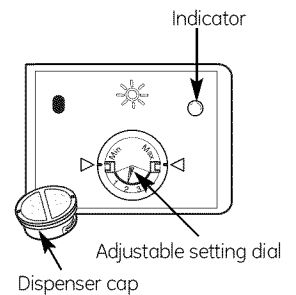

Rinse Aid Setting

The amount of rinse agent released into the final wash can be adjusted. The factory setting is at the midpoint. If there are rings of calcium (hard water) spots on dishes, try a higher setting. If you observe foam in the final rinse, try a lower setting.

To adjust the setting

Remove the dispenser cap, then turn the adjustable setting dial counterclockwise to increase the amount of rinse agent or clockwise to reduce the amount of rinse agent dispensed.

Dish Preparation Prior to Loading

- No pre-rinsing of normal food soil is required.
- Remove leafy vegetables, meat trimmings and excessive amounts of grease or oil.
- Remove acidic food soils that can discolor stainless steel.
- Scrape off hard soils, including bones, toothpicks, skins and seeds.
- Remove large quantities of any remaining food.



Proper Use of Detergent

Use only detergent specifically made for use in dishwashers. **Cascade®** and **Electrasol®** Automatic Dishwashing Detergents have been approved for use in all GE dishwashers. Keep your detergent fresh and dry. Don't put powder detergent into the dispenser until you're ready to wash dishes.

The amount of detergent to use depends on whether your water is *hard* or *soft*. With hard water, you need extra detergent. With soft water, you need less detergent.

Protect your dishes and dishwasher by contacting your water department and asking how hard your water is. Twelve or more grains is extremely hard water. A water softener is recommended. Without it, lime can build up in the water valve, which could stick while open and cause flooding. Too much detergent with soft water can cause a permanent cloudiness of glassware, called *etching*.

Use the information in the table below as a guideline to determine the amount of automatic dishwasher detergent to place in the dispenser.

Number of Grains	Detergent Cups to Fill
Less than 4	15 cup
4 to 8	25 cup
8 to 12	15 and 25 cups
Greater than 12	15, 25 cups and the open cup

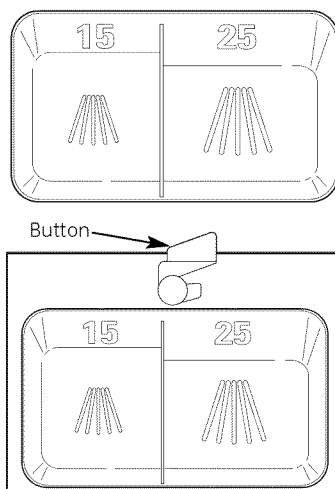

To open the wash cover, press the button and the cover will flip back.

For heavily-soiled loads, use the *Pots and Pans* or *Heavy Wash* cycle and add a little extra detergent.

DO NOT USE HAND DISH DETERGENT

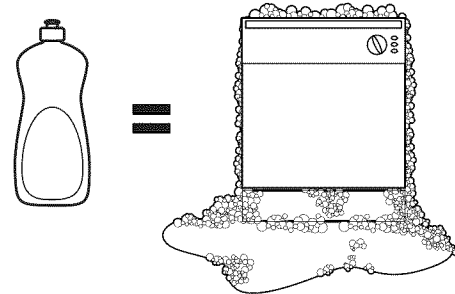

NOTE: Using a detergent that is not specifically designed for dishwashers will cause the dishwasher to fill with suds. During operation, these suds will spill out of the dishwasher vents, covering the kitchen floor and making the floor wet.

Because so many detergent containers look alike, store the dishwasher detergent in a separate space from all other cleaners. Show anyone who may use the dishwasher the correct detergent and where it is stored.

While there will be no lasting damage to the dishwasher, your dishes will not get clean using a dishwashing detergent that is not formulated to work with dishwashers.



Forget to Add a Dish?

A forgotten dish can be added any time before the main wash.

- 1 Squeeze the door latch to release the door.
- 2 Do not open the door until the water spray action stops. Steam may rise out of the dishwasher.

- 3 Add forgotten dishes.
- 4 Close the door.

Loading the dishwasher racks.

For best dishwashing results, follow these loading guidelines. Features and appearance of racks and silverware baskets may vary from your model.

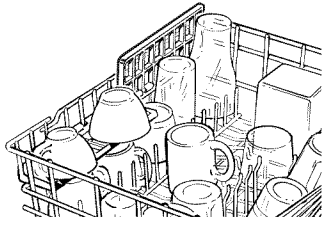

Upper Rack

Although the upper rack is for glasses, cups and saucers, pots and pans can be placed in this rack for effective cleaning. Cups and glasses fit best along the sides. This is also a secure place for dishwasher-safe plastics.

The upper rack is good for all kinds of odd-shaped utensils. Saucepans, mixing bowls and other items should be placed face down. Fold-down tines (on some models) provide flexibility for extra-large and hard-to-fit items.

Secure larger dishwasher-safe plastics over 2 tines when possible.

Make sure small plastic items are secure so they can't fall onto the heater.

Be sure that items do not protrude through the bottom of the rack and block rotation of the middle spray arm. This could result in poor wash performance for items in the upper rack.

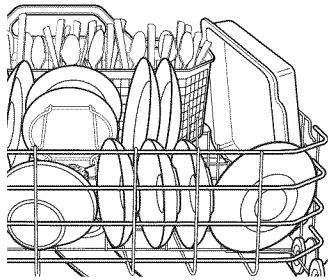

Lower Rack

The lower rack is best used for plates, saucers and cookware. Large items such as broiler pans and baking racks should go along the left-hand side. Load platters, pots and bowls along the sides, in corners or in the back. The soiled side of items should face the center of the rack. If necessary, oversized glasses and mugs can be placed in the lower rack to maximize loading flexibility.

Also, be careful not to let a portion of an item such as a pot or dish handle extend through the bottom rack. This could block the wash arm and cause poor washing results.

Fold-down tines (on some models) provide flexibility for extra-large and hard-to-fit items. The tines may be left in the up position or folded down to customize the lower rack.

Three-piece basket

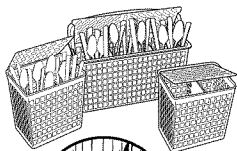

Don't let any item extend through bottom.

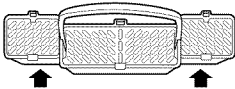

To remove end baskets, grasp the basket at opposite corners and slide apart.

Silverware Basket

To load flatware, simply push the adjustable handle to either side. Put flatware in the removable basket with fork and knife handles up to protect your hands. Place spoons in the basket with handles down. Mix knives, forks and spoons so they don't nest together. Distribute evenly. Small plastic items, such as measuring spoons and lids from small containers should go in the bottom of the silverware basket with the silverware on top.

A variety of options is available regarding the three-piece silverware basket in your dishwasher. The complete basket is designed to fit on the right side of the lower rack. Additionally, each end of the basket is removable to add loading flexibility to accommodate flatware and lower rack capacity needs.

The lids of both end and middle baskets (on some models) can be closed to contain small items. Long items can be placed on the utility shelf in the upper rack.

Cleaning the Exterior Door Panel

Before cleaning the front panel, make sure you know what type of panel you have. Refer to the last two letters of your model number. You can locate your model number on the left-hand tub wall just inside the door. If your model number ends with BB, WW or CC, then you have a Painted Door panel. If your model number ends with SS, then you have a Stainless Steel Door panel. If your model number ends with CS, then you have a CleanSteel Door panel.

Follow the instructions below for cleaning the door panel for your specific model.

Painted Door Panel (model numbers ending in BB–black, WW–white or CC–bisque)

Use a clean, soft, lightly dampened cloth, then dry thoroughly. You may also use a good appliance wax or polish.

Stainless Steel Door Panel (model numbers ending in SS)

The stainless steel panels can be cleaned with *Stainless Steel Magic* or a similar product using a clean, soft cloth. Do not use appliance wax, polish, bleach or products containing chlorine on Stainless Steel doors.

You can order *Stainless Steel Magic* #WX10X15 through GE Parts by calling 800.626.2002.

CleanSteel Door Panel (model numbers ending in CS)

Use a clean, soft, lightly dampened cloth, then dry thoroughly. Do not use appliance wax, polish or any chemical agent on CleanSteel doors.

Do not wipe the dishwasher with a soiled dish cloth or wet towel. These may leave a residue. Do not use scouring pads or powdered cleaners because these products can scratch the finish.

Cleaning the Control Panel

To clean the control panel, use a lightly dampened cloth. Then dry thoroughly.

Stainless Steel Interior—Tub and Inner Door

The stainless steel used to make the dishwasher tub and inner door provides the highest reliability available in a GE dishwasher. If the dishwasher tub or inner door should be scratched or dented during normal use, they will not rust or corrode. These surface blemishes will not affect their function or durability.

Caring for the dishwasher.

Spray Arms and Filters

The dishwasher will flush away all normal food soils. However, objects (fruit pits, bones, etc.) may collect in openings and should be removed occasionally to avoid clogging the drain system.

▲ CAUTION: *Personal injury hazard. Before cleaning the interior, wait at least 20 minutes after a cycle for the heating element to cool down. Failure to do so could result in burn injuries.*

Cleaning the Spray Arms

Because hard water chemicals will clog the spray arm jets and bearings, it is necessary to clean the spray arms regularly. To remove the spray arm, twist the retaining nut 90 degrees and pull the spray arm off the shaft.

Wash the arms in soapy, warm water and use a soft brush to clean the jets. Replace them after rinsing thoroughly.

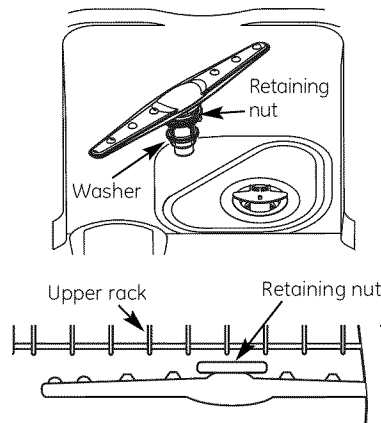

Cleaning the Filters

For best performance and results, the filter assembly must be cleaned regularly. The filter efficiently removes food particles from the wash water, allowing water to be recirculated during the cycle. For this reason, it is a good idea to remove the large food particles trapped in the filter frequently by rinsing the main filter and cup under running water. To remove the filter assembly, pull up on the cup handle. The entire filter assembly should be cleaned at least once a month. To clean the main filter and fine filter, use a cleaning brush. Then, reassemble the filter parts as shown in the illustration and reinsert the entire assembly in the dishwasher, positioning it in place and pressing downward. The dishwasher must never be used without the filters. Improper replacement of the filter may reduce the performance level of the appliance and may damage dishes and utensils.

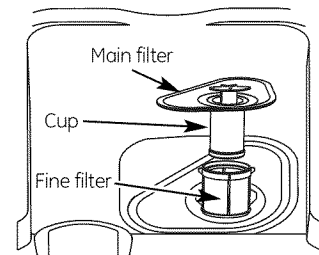

Protect Against Freezing

If your dishwasher is left in an unheated place during the winter, ask a service technician to:

- 1 Cut off electrical power to the dishwasher. Remove fuses or trip circuit breaker.
- 2 Turn off the water supply and disconnect the water inlet line from the water valve.

- 3 Drain water from the water inlet line and water valve. (Use a pan to catch the water.)
- 4 Reconnect the water inlet line to the water valve.

Does Your Dishwasher Have an Air Gap?

An air gap protects your dishwasher against water backing up into it if a drain clogs. The air gap is not a part of the dishwasher. It is not covered by your warranty. Not all plumbing codes require air gaps, so you may not have one.

The air gap is easy to clean.

- 1 Turn off the dishwasher and lift off the cover.
- 2 Remove the plastic cap and clean with a toothpick.

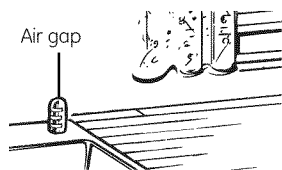

Check the air gap any time your dishwasher isn't draining well.



Troubleshooting Tips
 Save time and money! Review the charts on the following pages, or visit ge.com. You may not need to call for service.

Problem	Possible Causes	What To Do
Dishes and flatware not clean	Low inlet water temperature	<ul style="list-style-type: none"> Make sure inlet water temperature is correct (see page 6). Turn on the hot water faucet nearest the dishwasher, let run until the water temperature stops rising. Then start the dishwasher and turn off the faucet. This insures the entering water is hot.
	Water pressure is temporarily low	<ul style="list-style-type: none"> Turn on a faucet. Is water coming out more slowly than usual? If so, wait until pressure is normal before using your dishwasher.
	Air gap or disposer is clogged	<ul style="list-style-type: none"> Clean the air gap or flush the disposer.
	Improper rack loading	<ul style="list-style-type: none"> Make sure large dishware does not block the detergent dispenser or the wash arms. See the <i>Loading the dishwasher racks</i> section.
	No air gap or high drain loop	<ul style="list-style-type: none"> Verify that you have an air gap or a high drain loop. Refer to the Installation Instructions.
Spots and filming on glasses and flatware	Extremely hard water	<ul style="list-style-type: none"> Use <i>Jet-Dry</i>® or <i>Cascade Crystal Clear</i>® rinse agents to remove spots and prevent new film buildup.
	Low inlet water temperature Overloading the dishwasher Improper loading Old or damp powder detergent Rinse agent dispenser empty Too little detergent	<ul style="list-style-type: none"> To remove stubborn spots and pre-existing film from glassware: <ol style="list-style-type: none"> Remove all metal utensils from the dishwasher. Do not add detergent. Select the <i>POTS & PANS</i> cycle. Start the dishwasher and allow to run for 18 to 22 minutes. Dishwasher will now be in the main wash. Open the door and pour 2 cups (500 ml) of white vinegar into the bottom of the dishwasher. Close the door and allow to complete the cycle. If vinegar rinse doesn't work: Repeat as above, except use 1/4 cup (60 ml) of citric acid crystals instead of vinegar.
Cloudiness on glassware	Combination of soft water and too much detergent	<ul style="list-style-type: none"> This is called <i>etching</i> and is permanent. To prevent this from happening, use less detergent if you have soft water. Wash glassware in the shortest cycle that will get them clean.
	Water temperature entering the dishwasher exceeds 150°F	<ul style="list-style-type: none"> This could be etching. Lower the water heater temperature.
Suds in the tub	Correct detergent wasn't used	<ul style="list-style-type: none"> Use only automatic dishwasher detergents to avoid sudsing. <i>Cascade</i>® and <i>Electrasol</i>® Automatic Dishwashing Detergents have been approved for use in all GE dishwashers. To remove suds from the tub, open the dishwasher and let suds dissipate. Close and latch the dishwasher. Pump out water by touching the <i>START/RESET</i> pad once; then 30 seconds later, touch the <i>START/RESET</i> pad again. Repeat if necessary.
	Rinse agent was spilled	<ul style="list-style-type: none"> Always wipe up rinse agent spills immediately.

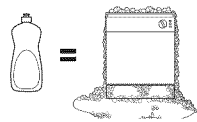

Before you call for service...

Problem	Possible Causes	What To Do
Detergent left in dispenser cups	Dishes are blocking the detergent cup	<ul style="list-style-type: none"> • Reposition the dishes, so the water from the lower spray arm can flush the detergent cup. See the <i>Loading the dishwasher</i> section.
Black or gray marks on dishes	Aluminum utensils have rubbed against dishes	<ul style="list-style-type: none"> • Remove marks with a mild, abrasive cleaner.
Dishes don't dry	Low inlet water temperature	<ul style="list-style-type: none"> • Make sure inlet water temperature is at least 120°F. • Select HEATED DRY. • Use HOT START, HOT WASH or ADDED HEAT options. • Select a higher cycle, such as POTS & PANS.
	Rinse agent dispenser is empty	<ul style="list-style-type: none"> • Check the rinse agent dispenser and fill as required.
Control panel responded to inputs but dishwasher never filled with water	Door latch may not be properly seated	<ul style="list-style-type: none"> • Make sure the door is firmly closed.
	Water valve may be turned off	<ul style="list-style-type: none"> • Make sure water valve (usually located under the sink) is turned on.
Stained tub interior	Some tomato-based foods can cause reddish stains	<ul style="list-style-type: none"> • Use of the RINSE ONLY cycle after adding the dish to the load can decrease the level of staining. GE recommends Cascade® Plastic Booster to help remove these types of stains.
	Tea or coffee stains	<ul style="list-style-type: none"> • Remove the stain by hand, using a solution of 1/2 cup bleach and 3 cups warm water. <p>▲ WARNING Before cleaning interior, wait at least 20 minutes after a cycle for the heating elements to cool down. Failure to do so can result in burns.</p>
	An overall yellow or brown film can be caused by iron deposits in water	<ul style="list-style-type: none"> • A special filter in the water supply line is the only way to correct this problem. Contact a water softener company.
	White film on inside surface—hard water minerals	<ul style="list-style-type: none"> • GE recommends Jet-Dry® or Cascade Crystal Clear® to help prevent hard water mineral deposits from forming. • Run dishwasher with citric acid to remove mineral deposits. Citric acid (Part number: WD35X151) can be ordered through GE Parts. See back cover for ordering information.
Dishwasher won't run	Fuse is blown or circuit breaker is tripped	<ul style="list-style-type: none"> • Replace fuse or reset circuit breaker. Remove any other appliances from the circuit.
	Power is turned off	<ul style="list-style-type: none"> • In some installations, the power to the dishwasher is provided through a wall switch, often located next to the disposer switch. Make sure it is on.
	Control panel is locked	<ul style="list-style-type: none"> • Unlock control panel. See page 4.
	Reboot your control	<ul style="list-style-type: none"> • Turn off power to the dishwasher (circuit breaker or wall switch) for 30 seconds; then turn back on.
Control panel lights go off when you're setting controls	Time too long between touching of selected pads	<ul style="list-style-type: none"> • Each pad must be touched within 30 seconds of the others. To relight, touch any pad again, or unlock and relatch door.
Water standing in the bottom of the tub	This is normal	<ul style="list-style-type: none"> • A small amount of clean water around the outlet on the tub bottom at the back of the tub keeps the water seal lubricated.
Water won't pump out of the tub	Drain is clogged	<ul style="list-style-type: none"> • If you have an air gap, clean it. See page 10. • If the dishwasher drains into a disposer, run disposer clear. • Check to see if your kitchen sink is draining well. If not, you may need a plumber.
Steam	This is normal	<ul style="list-style-type: none"> • Warm, moist air comes through the vent by the door latch during drying and when water is being pumped out. This is necessary for drying.
Sanitized light does not illuminate at the end of the cycle (Anti-Bacteria cycle only)	The door was opened and the cycle was interrupted during or after the main wash portion	<ul style="list-style-type: none"> • Do not interrupt the cycle anytime during or after main wash.
	The incoming water temperature was too low	<ul style="list-style-type: none"> • Raise the water heater temperature to between 120°F and 140°F.
Noise	Normal operating sounds	<ul style="list-style-type: none"> • Detergent cup opening. • Water entering dishwasher. • The motor stops and starts at various times during the cycle. • Drain pump sounds during the pump out.
	Rattling dishes when the spray arm rotates	<ul style="list-style-type: none"> • Make sure dishes are properly loaded. See the <i>Loading the dishwasher racks</i> section.

Notes.

<i>Safety Instructions</i>	<i>Operating Instructions</i>	<i>Troubleshooting Tips</i>	<i>Consumer Support</i>
----------------------------	-------------------------------	-----------------------------	-------------------------

Notes.

Safety Instructions

Operating Instructions

Troubleshooting Tips

Consumer Support

GE Dishwasher Warranty.



All warranty service provided by our Factory Service Centers, or an authorized Customer Care[®] technician. To schedule service, on-line, 24 hours a day, visit us at ge.com, or call 800.GE.CARES (800.432.2737). Please have serial number and model number available when calling for service.

Staple your receipt here.
Proof of the original purchase date is needed to obtain service under the warranty.

For The Period Of: GE Will Replace:

One Year

From the date of the original purchase

Any part of the dishwasher which fails due to a defect in materials or workmanship. During this **limited one-year warranty**, GE will also provide, **free of charge**, all labor and related service to replace the defective part.

What GE Will Not Cover:

- Service trips to your home to teach you how to use the product.
- Improper installation, delivery or maintenance.
- Failure of the product if it is abused, misused, or used for other than the intended purpose or used commercially.
- Replacement of house fuses or resetting of circuit breakers.
- Damage to the product caused by accident, fire, floods or acts of God.
- Incidental or consequential damage caused by possible defects with this appliance.
- Cleaning or servicing of the air gap device in the drain line.
- Damage caused after delivery.
- Product not accessible to provide required service.

EXCLUSION OF IMPLIED WARRANTIES—Your sole and exclusive remedy is product repair as provided in this Limited Warranty. Any implied warranties, including the implied warranties of merchantability or fitness for a particular purpose, are limited to one year or the shortest period allowed by law.

This warranty is extended to the original purchaser and any succeeding owner for products purchased for home use within the USA. If the product is located in an area where service by a GE Authorized Servicer is not available, you may be responsible for a trip charge or you may be required to bring the product to an Authorized GE Service location for service. Proof of original purchase date is needed to obtain service under the warranty. In Alaska, the warranty excludes the cost of shipping or service calls to your home.

Some states do not allow the exclusion or limitation of incidental or consequential damages. This warranty gives you specific legal rights, and you may also have other rights which vary from state to state. To know what your legal rights are, consult your local or state consumer affairs office or your state's Attorney General.

Warrantor: General Electric Company. Louisville, KY 40225

Consumer Support.



GE Appliances Website

ge.com

Have a question or need assistance with your appliance? Try the GE Appliances Website 24 hours a day, any day of the year! For greater convenience and faster service, you can now download Owner's Manuals, order parts or even schedule service on-line.

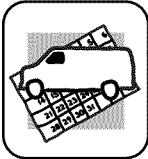

Schedule Service

ge.com

Expert GE repair service is only one step away from your door. Get on-line and schedule your service at your convenience 24 hours any day of the year! Or call 800.GE.CARES (800.432.2737) during normal business hours.

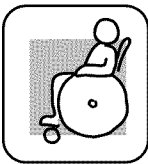

Real Life Design Studio

ge.com

GE supports the Universal Design concept—products, services and environments that can be used by people of all ages, sizes and capabilities. We recognize the need to design for a wide range of physical and mental abilities and impairments. For details of GE's Universal Design applications, including kitchen design ideas for people with disabilities, check out our Website today. For the hearing impaired, please call 800.TDD.GEAC (800.833.4322).



Extended Warranties

ge.com

Purchase a GE extended warranty and learn about special discounts that are available while your warranty is still in effect. You can purchase it on-line anytime, or call 800.626.2224 during normal business hours. GE Consumer Home Services will still be there after your warranty expires.

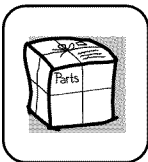

Parts and Accessories

ge.com

Individuals qualified to service their own appliances can have parts or accessories sent directly to their homes (VISA, MasterCard and Discover cards are accepted). Order on-line today, 24 hours every day or by phone at 800.626.2002 during normal business hours.

Instructions contained in this manual cover procedures to be performed by any user. Other servicing generally should be referred to qualified service personnel. Caution must be exercised, since improper servicing may cause unsafe operation.



Contact Us

ge.com

If you are not satisfied with the service you receive from GE, contact us on our Website with all the details including your phone number, or write to:

General Manager, Customer Relations
GE Appliances, Appliance Park
Louisville, KY 40225



Register Your Appliance

ge.com

Register your new appliance on-line—at your convenience! Timely product registration will allow for enhanced communication and prompt service under the terms of your warranty, should the need arise. You may also mail in the pre-printed registration card included in the packing material, or detach and use the form in this Owner's Manual.





Dishwashers

Safety Instructions 2, 3

Operating Instructions

Care and Cleaning 9-10

Control Panel and Settings 4-5

Loading the Racks 8

Using the Dishwasher 6-7

Troubleshooting Tips 11-12

Consumer Support

Consumer Support Back Cover

Warranty 15

Owner's Manual

GLDA690

GLDA696

Write the model and serial numbers here:

Model # _____

Serial # _____

You can find them on the tub wall just inside the door.

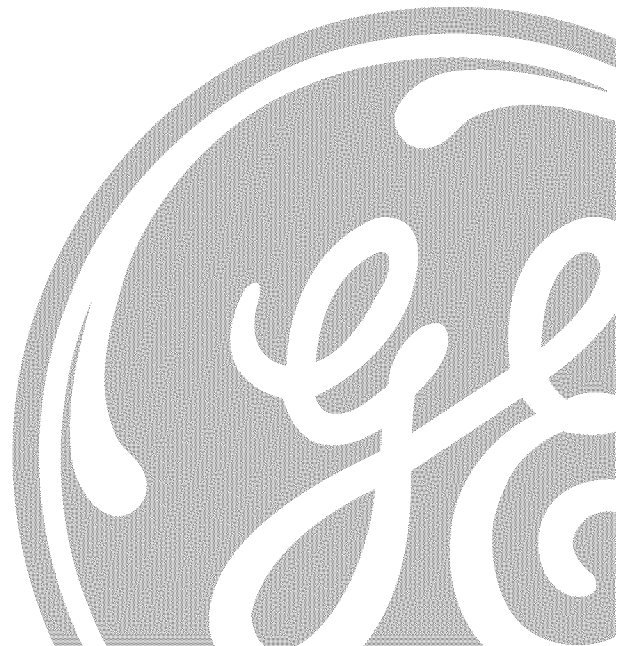

IMPORTANT SAFETY INFORMATION.

READ ALL INSTRUCTIONS BEFORE USING —

SAVE THESE INSTRUCTIONS

▲ WARNING!

For your safety, the information in this manual must be followed to minimize the risk of fire or explosion, electric shock, and to prevent property damage, personal injury, or death.



▲ WARNING! WATER HEATER SAFETY

Under certain conditions, hydrogen gas may be produced in a water heater that has not been used for two weeks or more. **HYDROGEN GAS IS EXPLOSIVE.**

If the hot water has not been used for two weeks or more, prevent the possibility of damage or injury by turning on all hot water faucets and allow them to run for several minutes. Do this before using any electrical appliance which is connected to the hot water system. This simple procedure will allow any built-up hydrogen gas to escape. Since the gas is flammable, do not smoke or use an open flame or appliance during this process.



PROPER INSTALLATION AND MAINTENANCE

This dishwasher must be properly installed and located in accordance with the Installation Instructions before it is used. If you did not receive an Installation Instructions sheet with your dishwasher, you can receive one by visiting our website at ge.com.

- Connect to a grounded metal, permanent wiring system; or run an equipment-grounding conductor with the circuit conductors and connect to the equipment-grounding terminal or lead of the appliance.
- Improper connection of the equipment-grounding conductor can result in a risk of electric shock. Check with a qualified electrician or service representative if you are in doubt whether the appliance is properly grounded.
- Dispose of discarded appliances and shipping or packing material properly.
- Do not attempt to repair or replace any part of your dishwasher unless it is specifically recommended in this manual. All other servicing should be referred to a qualified technician.
- To minimize the possibility of electric shock, disconnect this appliance from the power supply before attempting any maintenance.

NOTE: Turning the dishwasher off does not disconnect the appliance from the power supply. We recommend having a qualified technician service your appliance.

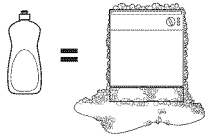
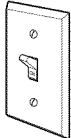

▲ CAUTION: To prevent minor injury or property damage

- Contents washed in Anti-bacterial mode, if available, may be hot to the touch. Use care before handling.
- Using a detergent that is not specifically designed for dishwashers will cause the dishwasher to fill with suds. 
- If your dishwasher is connected to a wall switch, ensure that the switch is on prior to use. 
- On dishwashers with electronic controls, if you choose to turn the wall switch off between wash cycles, allow 5-10 seconds after turning the switch on before touching START/RESET to allow the control to reboot.
- Non-Dishware Items: Do not wash items such as electronic air cleaner filters, furnace filters and paint brushes in your dishwasher. Damage to dishwasher and discoloration or staining of dishwasher may result.
- Close supervision is necessary if this appliance is used by or near children.
- Load light, plastic items so they will not become dislodged and drop to the bottom of the dishwasher—they might come into contact with the heating element and be damaged.

▲ **WARNING! RISK OF CHILD ENTRAPMENT** **PROPER DISPOSAL OF THE DISHWASHER**

Junked or abandoned dishwashers are dangerous... even if they will sit for "just a few days." If you are getting rid of your old dishwasher, please follow the instructions to help prevent accidents.

Before You Throw Away Your Old Dishwasher

Take off the door of the washing compartment or remove the door latch (as shown).

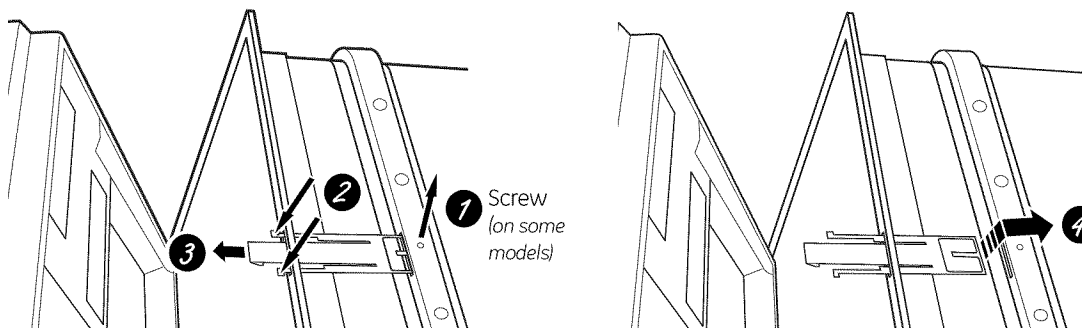

▲ **WARNING!**

When using your dishwasher, follow basic precautions, including the following:

- Use this appliance only for its intended purpose as described in this Owner's Manual.
- Use only powder, tabs, liquid detergents or rinse agents recommended for use in a dishwasher and keep them out of the reach of children. **Cascade®**, **Cascade® Complete** and **Electrasol®** Automatic Dishwashing Detergents, and **Jet-Dry®** and **Cascade Crystal Clear®** rinse agents have been approved for use in all GE dishwashers.
- **Do not mix any chlorine bleach-based automatic dishwashing detergent with any dishwashing detergent containing enzymes as this could cause the detergents to congeal and lead to blockage of the SmartDispense™ system.**
- Locate sharp items so that they are not likely to damage the door seal.
- Load sharp knives with the handles up to reduce the risk of cut-type injuries.
- Do not wash plastic items unless marked dishwasher safe or the equivalent. For plastic items not so marked, check the manufacturer's recommendations.
- Do not touch the heating element during or immediately after use.
- Do not operate your dishwasher unless all enclosure panels are properly in place.
- Do not tamper with controls.
- Do not abuse, sit on or stand on the door or dish rack of the dishwasher.
- Do not allow children to play around dishwasher when opening or closing door due to the possibility of small fingers being pinched in door.
- Do not discard a dishwasher without first removing the door of the washing compartment or the door latch.
- Do not store or use combustible materials, gasoline or other flammable vapors and liquids in the vicinity of this or any other appliance.
- Do not allow children to play with, on or inside this appliance or any discarded appliance.



READ AND FOLLOW THIS SAFETY INFORMATION CAREFULLY.

SAVE THESE INSTRUCTIONS

About the dishwasher control panel.

Throughout this manual, features and appearance may vary from your model.

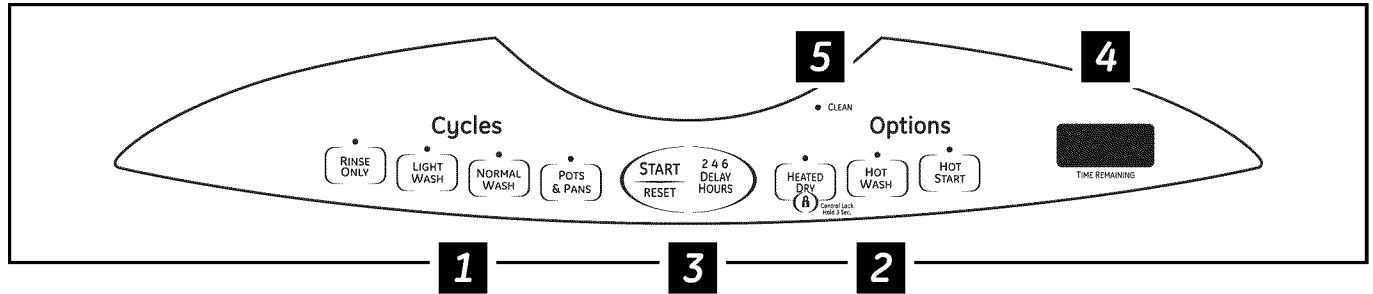

Control Settings

1 Wash Cycles

- POTS & PANS** 7.4 gal., 85 min.
This cycle is meant for heavily soiled dishes or cookware with dried-on or baked-on soils. This cycle may not remove burned-on foods. Everyday dishes are safe to be used in this cycle.
- NORMAL WASH** 5.3 gal., 56 min.
This cycle is for medium/heavily soiled dishes and glassware.
- LIGHT WASH** 4.2 gal., 33 min.
This cycle is for lightly soiled dishes and glassware.
- RINSE ONLY** 2.1 gal., 7 min.
This cycle is for rinsing partial loads that will be washed later.
DO NOT use detergent or HEATED DRY Option with this cycle.

2 Options

The light above the selected pad will be ON to indicate which OPTION has been selected.

- HEATED DRY** Turns the heater on for fast drying. This will extend the total cycle time by approximately 38 minutes for a **NORMAL WASH** cycle.
Light ON
NOTE: Cannot be selected with **RINSE ONLY** cycle.
- HEATED DRY** Shuts off the drying heat option. Dishes will air dry naturally to save energy.
Light OFF
- HOT WASH** When selected, the cycle will run a little longer with heated elements on to improve both wash and dry performance. Adds approximately 15 minutes to the cycle.
NOTE: Cannot be selected with **RINSE ONLY** cycle.
- HOT START** For use with heavily soiled and/or dried-on, baked-on soils. This option **MUST** be selected **PRIOR** to starting the cycle. This option adds approximately 22 minutes to the cycle and two additional rinses to the cycle.
NOTE: Cannot be selected with **RINSE ONLY** cycle.
- LOCK** You can lock the controls to prevent any selections from being made. Or you can lock the controls after you have started a cycle.

Children cannot accidentally start dishwasher by touching pads with this option selected.
To unlock the dishwasher controls, press and hold the **HEATED DRY** pad for 3 seconds. The light above the lock pad will turn off. To lock the dishwasher, press and hold the **HEATED DRY** pad for 3 seconds. The light above the **LOCK** pad will turn on.

3 Start/Reset

Close and latch the dishwasher door and select the cycle and desired enhancements. Touch the **START/RESET** pad to begin the cycle. The water fill begins immediately, and approximately 60 seconds later the wash action begins.

When the dishwasher door is fully closed and latched, the control panel lights will display the last settings you selected. If you don't want to change any of the settings, simply touch the **START/RESET** pad to begin the cycle.

If the door is closed, the indicator lights will turn off if the **START/RESET** pad is not selected within 5 minutes. To activate the display, open and close the door or press any pad.

DELAY HOURS You can delay the start of a wash cycle for up to 6 hours. Press the **DELAY START** pad to choose the number of hours you want to delay the start of the cycle; then press **START/RESET**.

The machine will count down and start automatically at the correct time.

NOTE: To cancel the **DELAY START** selection before the cycle begins, repeatedly press the **DELAY START** pad until the display is blank.

RESET To change a cycle after washing starts:

Touch the **START/RESET** pad to cancel the cycle. The **START/RESET** light will flash while the water is pumped out, if needed. This takes approximately 2 minutes.

4 Time Remaining Display *(on some models)*

During operation, the display shows the minutes remaining until the cycle is complete. The display may adjust the remaining time while the **SENSING** light is on. The time displayed at the start of each cycle may change from the factory setting as the unit customizes itself to home use. During a delay start, the display will show hours of time remaining until the cycle starts.

5 Clean

The **CLEAN** light is illuminated when the selected cycle and enhancements are complete. The light will stay **ON** until a pad is pressed or the door is opened and then closed.

Using the dishwasher.



Check the Water Temperature

The entering water should be at least 120°F and not more than 150°F, for effective cleaning and to prevent dish damage. Check the water temperature with a candy or meat thermometer. Turn on the hot

water faucet nearest the dishwasher, place the thermometer in a glass and let the water run continuously into the glass until the temperature stops rising.



Use Jet-Dry® or Cascade Crystal Clear® Rinse Agent

Jet-Dry® or **Cascade Crystal Clear®** rinse agents remove spots and prevent new film buildup on your dishes, glasses, flatware, cookware and plastic.

Filling the Dispenser

The rinse agent dispenser holds 3.5 oz. of rinse agent. Under normal conditions, this will last approximately one month. Refill when rinse agent is not visible in the indicator. Do not overfill.

- 1 Make sure the dishwasher door is fully open.
- 2 Turn the dispenser cap to the left and lift it out.
- 3 Add rinse agent until the indicator window looks full. Do not overfill.
- 4 Clean up any spilled rinse agent with a damp cloth to prevent foam.
- 5 Replace the dispenser cap.

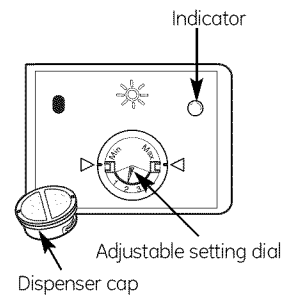

Rinse Aid Setting

The amount of rinse agent released into the final wash can be adjusted. The factory setting is at the midpoint. If there are rings of calcium (hard water) spots on dishes, try a higher setting. If you observe foam in the final rinse, try a lower setting.

To adjust the setting

Remove the dispenser cap, then turn the adjustable setting dial counterclockwise to increase the amount of rinse agent or clockwise to reduce the amount of rinse agent dispensed.

Dish Preparation Prior to Loading

- No pre-rinsing of normal food soil is required.
- Remove leafy vegetables, meat trimmings and excessive amounts of grease or oil.
- Remove acidic food soils that can discolor stainless steel.
- Scrape off hard soils, including bones, toothpicks, skins and seeds.
- Remove large quantities of any remaining food.



Proper Use of Detergent

Use only detergent specifically made for use in dishwashers. **Cascade®** and **Electrasol®** Automatic Dishwashing Detergents have been approved for use in all GE dishwashers. Keep your detergent fresh and dry. Don't put powder detergent into the dispenser until you're ready to wash dishes.

The amount of detergent to use depends on whether your water is *hard* or *soft*. With hard water, you need extra detergent. With soft water, you need less detergent.

Protect your dishes and dishwasher by contacting your water department and asking how hard your water is. Twelve or more grains is extremely hard water. A water softener is recommended. Without it, lime can build up in the water valve, which could stick while open and cause flooding. Too much detergent with soft water can cause a permanent cloudiness of glassware, called *etching*.

Use the information in the table below as a guideline to determine the amount of automatic dishwasher detergent to place in the dispenser.

Number of Grains	Detergent Cups to Fill
Less than 4	15 cup
4 to 8	25 cup
8 to 12	15 and 25 cups
Greater than 12	15, 25 cups and the open cup

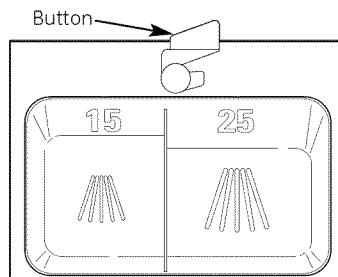
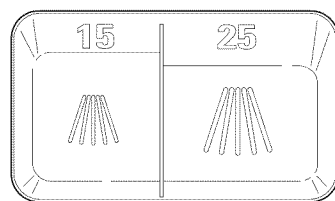

To open the wash cover, press the button and the cover will flip back.

For heavily-soiled loads, use the *Pots and Pans* or *Heavy Wash* cycle and add a little extra detergent.

DO NOT USE HAND DISH DETERGENT

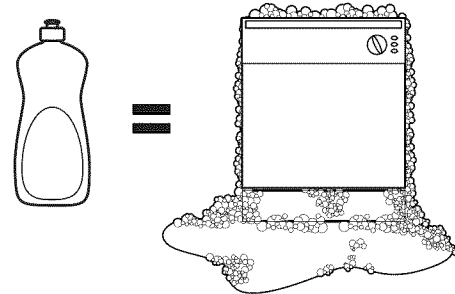

NOTE: Using a detergent that is not specifically designed for dishwashers will cause the dishwasher to fill with suds. During operation, these suds will spill out of the dishwasher vents, covering the kitchen floor and making the floor wet.

Because so many detergent containers look alike, store the dishwasher detergent in a separate space from all other cleaners. Show anyone who may use the dishwasher the correct detergent and where it is stored.

While there will be no lasting damage to the dishwasher, your dishes will not get clean using a dishwashing detergent that is not formulated to work with dishwashers.



Forget to Add a Dish?

A forgotten dish can be added any time before the main wash.

- 1 Squeeze the door latch to release the door.
- 2 Do not open the door until the water spray action stops. Steam may rise out of the dishwasher.

- 3 Add forgotten dishes.
- 4 Close the door.

Loading the dishwasher racks.

For best dishwashing results, follow these loading guidelines. Features and appearance of racks and silverware baskets may vary from your model.

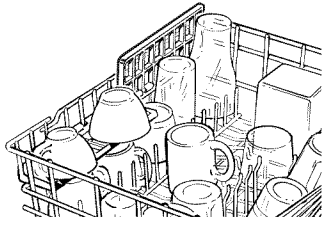

Upper Rack

Although the upper rack is for glasses, cups and saucers, pots and pans can be placed in this rack for effective cleaning. Cups and glasses fit best along the sides. This is also a secure place for dishwasher-safe plastics.

The upper rack is good for all kinds of odd-shaped utensils. Saucepans, mixing bowls and other items should be placed face down. Fold-down tines (on some models) provide flexibility for extra-large and hard-to-fit items.

Secure larger dishwasher-safe plastics over 2 tines when possible.

Make sure small plastic items are secure so they can't fall onto the heater.

Be sure that items do not protrude through the bottom of the rack and block rotation of the middle spray arm. This could result in poor wash performance for items in the upper rack.

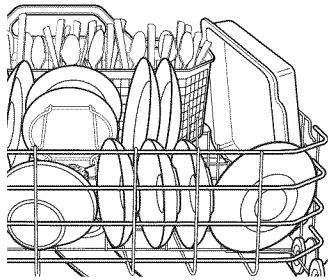

Lower Rack

The lower rack is best used for plates, saucers and cookware. Large items such as broiler pans and baking racks should go along the left-hand side. Load platters, pots and bowls along the sides, in corners or in the back. The soiled side of items should face the center of the rack. If necessary, oversized glasses and mugs can be placed in the lower rack to maximize loading flexibility.

Also, be careful not to let a portion of an item such as a pot or dish handle extend through the bottom rack. This could block the wash arm and cause poor washing results.

Fold-down tines (on some models) provide flexibility for extra-large and hard-to-fit items. The tines may be left in the up position or folded down to customize the lower rack.

Three-piece basket

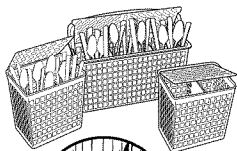

Don't let any item extend through bottom.

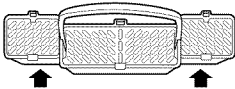

To remove end baskets, grasp the basket at opposite corners and slide apart.

Silverware Basket

To load flatware, simply push the adjustable handle to either side. Put flatware in the removable basket with fork and knife handles up to protect your hands. Place spoons in the basket with handles down. Mix knives, forks and spoons so they don't nest together. Distribute evenly. Small plastic items, such as measuring spoons and lids from small containers should go in the bottom of the silverware basket with the silverware on top.

A variety of options is available regarding the three-piece silverware basket in your dishwasher. The complete basket is designed to fit on the right side of the lower rack. Additionally, each end of the basket is removable to add loading flexibility to accommodate flatware and lower rack capacity needs.

The lids of both end and middle baskets (on some models) can be closed to contain small items. Long items can be placed on the utility shelf in the upper rack.

Cleaning the Exterior Door Panel

Before cleaning the front panel, make sure you know what type of panel you have. Refer to the last two letters of your model number. You can locate your model number on the left-hand tub wall just inside the door. If your model number ends with BB, WW or CC, then you have a Painted Door panel. If your model number ends with SS, then you have a Stainless Steel Door panel. If your model number ends with CS, then you have a CleanSteel Door panel.

Follow the instructions below for cleaning the door panel for your specific model.

Painted Door Panel (model numbers ending in BB–black, WW–white or CC–bisque)

Use a clean, soft, lightly dampened cloth, then dry thoroughly. You may also use a good appliance wax or polish.

Stainless Steel Door Panel (model numbers ending in SS)

The stainless steel panels can be cleaned with *Stainless Steel Magic* or a similar product using a clean, soft cloth. Do not use appliance wax, polish, bleach or products containing chlorine on Stainless Steel doors.

You can order *Stainless Steel Magic* #WX10X15 through GE Parts by calling 800.626.2002.

CleanSteel Door Panel (model numbers ending in CS)

Use a clean, soft, lightly dampened cloth, then dry thoroughly. Do not use appliance wax, polish or any chemical agent on CleanSteel doors.

Do not wipe the dishwasher with a soiled dish cloth or wet towel. These may leave a residue. Do not use scouring pads or powdered cleaners because these products can scratch the finish.

Cleaning the Control Panel

To clean the control panel, use a lightly dampened cloth. Then dry thoroughly.

Stainless Steel Interior—Tub and Inner Door

The stainless steel used to make the dishwasher tub and inner door provides the highest reliability available in a GE dishwasher. If the dishwasher tub or inner door should be scratched or dented during normal use, they will not rust or corrode. These surface blemishes will not affect their function or durability.

Caring for the dishwasher.

Spray Arms and Filters

The dishwasher will flush away all normal food soils. However, objects (fruit pits, bones, etc.) may collect in openings and should be removed occasionally to avoid clogging the drain system.

▲ CAUTION: *Personal injury hazard. Before cleaning the interior, wait at least 20 minutes after a cycle for the heating element to cool down. Failure to do so could result in burn injuries.*

Cleaning the Spray Arms

Because hard water chemicals will clog the spray arm jets and bearings, it is necessary to clean the spray arms regularly. To remove the spray arm, twist the retaining nut 90 degrees and pull the spray arm off the shaft.

Wash the arms in soapy, warm water and use a soft brush to clean the jets. Replace them after rinsing thoroughly.

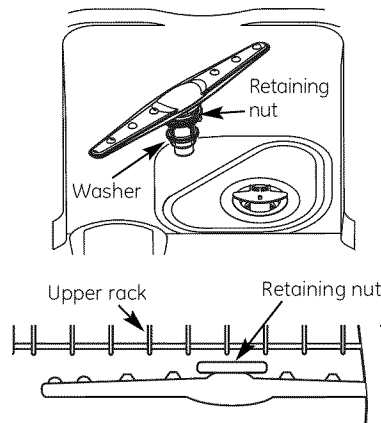

Cleaning the Filters

For best performance and results, the filter assembly must be cleaned regularly. The filter efficiently removes food particles from the wash water, allowing water to be recirculated during the cycle. For this reason, it is a good idea to remove the large food particles trapped in the filter frequently by rinsing the main filter and cup under running water. To remove the filter assembly, pull up on the cup handle. The entire filter assembly should be cleaned at least once a month. To clean the main filter and fine filter, use a cleaning brush. Then, reassemble the filter parts as shown in the illustration and reinsert the entire assembly in the dishwasher, positioning it in place and pressing downward. The dishwasher must never be used without the filters. Improper replacement of the filter may reduce the performance level of the appliance and may damage dishes and utensils.

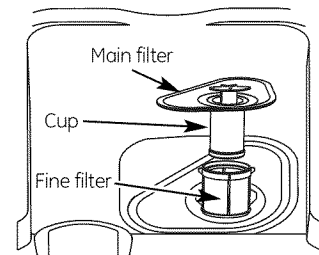

Protect Against Freezing

If your dishwasher is left in an unheated place during the winter, ask a service technician to:

- 1 Cut off electrical power to the dishwasher. Remove fuses or trip circuit breaker.
- 2 Turn off the water supply and disconnect the water inlet line from the water valve.

- 3 Drain water from the water inlet line and water valve. (Use a pan to catch the water.)
- 4 Reconnect the water inlet line to the water valve.

Does Your Dishwasher Have an Air Gap?

An air gap protects your dishwasher against water backing up into it if a drain clogs. The air gap is not a part of the dishwasher. It is not covered by your warranty. Not all plumbing codes require air gaps, so you may not have one.

The air gap is easy to clean.

- 1 Turn off the dishwasher and lift off the cover.
- 2 Remove the plastic cap and clean with a toothpick.

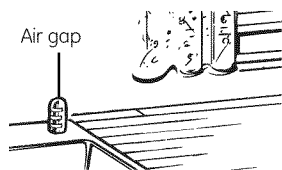

Check the air gap any time your dishwasher isn't draining well.

Before you call for service...

ge.com



Troubleshooting Tips
Save time and money! Review the charts on the following pages, or visit ge.com. You may not need to call for service.

Problem	Possible Causes	What To Do
Dishes and flatware not clean	Low inlet water temperature	<ul style="list-style-type: none"> Make sure inlet water temperature is correct (see page 6). Turn on the hot water faucet nearest the dishwasher, let run until the water temperature stops rising. Then start the dishwasher and turn off the faucet. This insures the entering water is hot.
	Water pressure is temporarily low	<ul style="list-style-type: none"> Turn on a faucet. Is water coming out more slowly than usual? If so, wait until pressure is normal before using your dishwasher.
	Air gap or disposer is clogged	<ul style="list-style-type: none"> Clean the air gap or flush the disposer.
	Improper rack loading	<ul style="list-style-type: none"> Make sure large dishware does not block the detergent dispenser or the wash arms. See the <i>Loading the dishwasher racks</i> section.
	No air gap or high drain loop	<ul style="list-style-type: none"> Verify that you have an air gap or a high drain loop. Refer to the Installation Instructions.
Spots and filming on glasses and flatware	Extremely hard water	<ul style="list-style-type: none"> Use <i>Jet-Dry</i>® or <i>Cascade Crystal Clear</i>® rinse agents to remove spots and prevent new film buildup.
	Low inlet water temperature Overloading the dishwasher Improper loading Old or damp powder detergent Rinse agent dispenser empty Too little detergent	<ul style="list-style-type: none"> To remove stubborn spots and pre-existing film from glassware: <ol style="list-style-type: none"> Remove all metal utensils from the dishwasher. Do not add detergent. Select the <i>POTS & PANS</i> cycle. Start the dishwasher and allow to run for 18 to 22 minutes. Dishwasher will now be in the main wash. Open the door and pour 2 cups (500 ml) of white vinegar into the bottom of the dishwasher. Close the door and allow to complete the cycle. If vinegar rinse doesn't work: Repeat as above, except use 1/4 cup (60 ml) of citric acid crystals instead of vinegar.
Cloudiness on glassware	Combination of soft water and too much detergent	<ul style="list-style-type: none"> This is called <i>etching</i> and is permanent. To prevent this from happening, use less detergent if you have soft water. Wash glassware in the shortest cycle that will get them clean.
	Water temperature entering the dishwasher exceeds 150°F	<ul style="list-style-type: none"> This could be etching. Lower the water heater temperature.
Suds in the tub	Correct detergent wasn't used	<ul style="list-style-type: none"> Use only automatic dishwasher detergents to avoid sudsing. <i>Cascade</i>® and <i>Electrasol</i>® Automatic Dishwashing Detergents have been approved for use in all GE dishwashers. To remove suds from the tub, open the dishwasher and let suds dissipate. Close and latch the dishwasher. Pump out water by touching the START/RESET pad once; then 30 seconds later, touch the START/RESET pad again. Repeat if necessary.
	Rinse agent was spilled	<ul style="list-style-type: none"> Always wipe up rinse agent spills immediately.

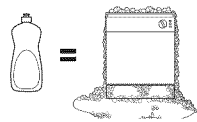

Safety Instructions

Operating Instructions

Troubleshooting Tips

Consumer Support

Before you call for service...

Problem	Possible Causes	What To Do
Detergent left in dispenser cups	Dishes are blocking the detergent cup	<ul style="list-style-type: none"> • Reposition the dishes, so the water from the lower spray arm can flush the detergent cup. See the <i>Loading the dishwasher</i> section.
Black or gray marks on dishes	Aluminum utensils have rubbed against dishes	<ul style="list-style-type: none"> • Remove marks with a mild, abrasive cleaner.
Dishes don't dry	Low inlet water temperature	<ul style="list-style-type: none"> • Make sure inlet water temperature is at least 120°F. • Select HEATED DRY. • Use HOT START, HOT WASH or ADDED HEAT options. • Select a higher cycle, such as POTS & PANS.
	Rinse agent dispenser is empty	<ul style="list-style-type: none"> • Check the rinse agent dispenser and fill as required.
Control panel responded to inputs but dishwasher never filled with water	Door latch may not be properly seated	<ul style="list-style-type: none"> • Make sure the door is firmly closed.
	Water valve may be turned off	<ul style="list-style-type: none"> • Make sure water valve (usually located under the sink) is turned on.
Stained tub interior	Some tomato-based foods can cause reddish stains	<ul style="list-style-type: none"> • Use of the RINSE ONLY cycle after adding the dish to the load can decrease the level of staining. GE recommends Cascade® Plastic Booster to help remove these types of stains.
	Tea or coffee stains	<ul style="list-style-type: none"> • Remove the stain by hand, using a solution of 1/2 cup bleach and 3 cups warm water. <p>▲ WARNING Before cleaning interior, wait at least 20 minutes after a cycle for the heating elements to cool down. Failure to do so can result in burns.</p>
	An overall yellow or brown film can be caused by iron deposits in water	<ul style="list-style-type: none"> • A special filter in the water supply line is the only way to correct this problem. Contact a water softener company.
	White film on inside surface—hard water minerals	<ul style="list-style-type: none"> • GE recommends Jet-Dry® or Cascade Crystal Clear® to help prevent hard water mineral deposits from forming. • Run dishwasher with citric acid to remove mineral deposits. Citric acid (Part number: WD35X151) can be ordered through GE Parts. See back cover for ordering information.
Dishwasher won't run	Fuse is blown or circuit breaker is tripped	<ul style="list-style-type: none"> • Replace fuse or reset circuit breaker. Remove any other appliances from the circuit.
	Power is turned off	<ul style="list-style-type: none"> • In some installations, the power to the dishwasher is provided through a wall switch, often located next to the disposer switch. Make sure it is on.
	Control panel is locked	<ul style="list-style-type: none"> • Unlock control panel. See page 4.
	Reboot your control	<ul style="list-style-type: none"> • Turn off power to the dishwasher (circuit breaker or wall switch) for 30 seconds; then turn back on.
Control panel lights go off when you're setting controls	Time too long between touching of selected pads	<ul style="list-style-type: none"> • Each pad must be touched within 30 seconds of the others. To relight, touch any pad again, or unlock and relatch door.
Water standing in the bottom of the tub	This is normal	<ul style="list-style-type: none"> • A small amount of clean water around the outlet on the tub bottom at the back of the tub keeps the water seal lubricated.
Water won't pump out of the tub	Drain is clogged	<ul style="list-style-type: none"> • If you have an air gap, clean it. See page 10. • If the dishwasher drains into a disposer, run disposer clear. • Check to see if your kitchen sink is draining well. If not, you may need a plumber.
Steam	This is normal	<ul style="list-style-type: none"> • Warm, moist air comes through the vent by the door latch during drying and when water is being pumped out. This is necessary for drying.
Sanitized light does not illuminate at the end of the cycle (Anti-Bacteria cycle only)	The door was opened and the cycle was interrupted during or after the main wash portion	<ul style="list-style-type: none"> • Do not interrupt the cycle anytime during or after main wash.
	The incoming water temperature was too low	<ul style="list-style-type: none"> • Raise the water heater temperature to between 120°F and 140°F.
Noise	Normal operating sounds	<ul style="list-style-type: none"> • Detergent cup opening. • Water entering dishwasher. • The motor stops and starts at various times during the cycle. • Drain pump sounds during the pump out.
	Rattling dishes when the spray arm rotates	<ul style="list-style-type: none"> • Make sure dishes are properly loaded. See the <i>Loading the dishwasher racks</i> section.

Notes.

<i>Safety Instructions</i>	<i>Operating Instructions</i>	<i>Troubleshooting Tips</i>	<i>Consumer Support</i>
----------------------------	-------------------------------	-----------------------------	-------------------------

Consumer Support

Troubleshooting Tips

Operating Instructions

Safety Instructions

Notes.

GE Dishwasher Warranty.



All warranty service provided by our Factory Service Centers, or an authorized Customer Care[®] technician. To schedule service, on-line, 24 hours a day, visit us at ge.com, or call 800.GE.CARES (800.432.2737). Please have serial number and model number available when calling for service.

Staple your receipt here.
Proof of the original purchase date is needed to obtain service under the warranty.

For The Period Of: GE Will Replace:

One Year

From the date of the original purchase

Any part of the dishwasher which fails due to a defect in materials or workmanship. During this **limited one-year warranty**, GE will also provide, **free of charge**, all labor and related service to replace the defective part.

What GE Will Not Cover:

- Service trips to your home to teach you how to use the product.
- Improper installation, delivery or maintenance.
- Failure of the product if it is abused, misused, or used for other than the intended purpose or used commercially.
- Replacement of house fuses or resetting of circuit breakers.
- Damage to the product caused by accident, fire, floods or acts of God.
- Incidental or consequential damage caused by possible defects with this appliance.
- Cleaning or servicing of the air gap device in the drain line.
- Damage caused after delivery.
- Product not accessible to provide required service.

EXCLUSION OF IMPLIED WARRANTIES—Your sole and exclusive remedy is product repair as provided in this Limited Warranty. Any implied warranties, including the implied warranties of merchantability or fitness for a particular purpose, are limited to one year or the shortest period allowed by law.

This warranty is extended to the original purchaser and any succeeding owner for products purchased for home use within the USA. If the product is located in an area where service by a GE Authorized Servicer is not available, you may be responsible for a trip charge or you may be required to bring the product to an Authorized GE Service location for service. Proof of original purchase date is needed to obtain service under the warranty. In Alaska, the warranty excludes the cost of shipping or service calls to your home.

Some states do not allow the exclusion or limitation of incidental or consequential damages. This warranty gives you specific legal rights, and you may also have other rights which vary from state to state. To know what your legal rights are, consult your local or state consumer affairs office or your state's Attorney General.

Warrantor: General Electric Company. Louisville, KY 40225

Consumer Support.



GE Appliances Website

ge.com

Have a question or need assistance with your appliance? Try the GE Appliances Website 24 hours a day, any day of the year! For greater convenience and faster service, you can now download Owner's Manuals, order parts or even schedule service on-line.

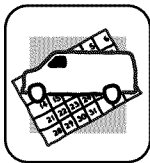

Schedule Service

ge.com

Expert GE repair service is only one step away from your door. Get on-line and schedule your service at your convenience 24 hours any day of the year! Or call 800.GE.CARES (800.432.2737) during normal business hours.

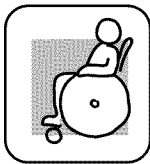

Real Life Design Studio

ge.com

GE supports the Universal Design concept—products, services and environments that can be used by people of all ages, sizes and capabilities. We recognize the need to design for a wide range of physical and mental abilities and impairments. For details of GE's Universal Design applications, including kitchen design ideas for people with disabilities, check out our Website today. For the hearing impaired, please call 800.TDD.GEAC (800.833.4322).



Extended Warranties

ge.com

Purchase a GE extended warranty and learn about special discounts that are available while your warranty is still in effect. You can purchase it on-line anytime, or call 800.626.2224 during normal business hours. GE Consumer Home Services will still be there after your warranty expires.

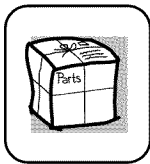

Parts and Accessories

ge.com

Individuals qualified to service their own appliances can have parts or accessories sent directly to their homes (VISA, MasterCard and Discover cards are accepted). Order on-line today, 24 hours every day or by phone at 800.626.2002 during normal business hours.

Instructions contained in this manual cover procedures to be performed by any user. Other servicing generally should be referred to qualified service personnel. Caution must be exercised, since improper servicing may cause unsafe operation.



Contact Us

ge.com

If you are not satisfied with the service you receive from GE, contact us on our Website with all the details including your phone number, or write to:

General Manager, Customer Relations
GE Appliances, Appliance Park
Louisville, KY 40225



Register Your Appliance

ge.com

Register your new appliance on-line—at your convenience! Timely product registration will allow for enhanced communication and prompt service under the terms of your warranty, should the need arise. You may also mail in the pre-printed registration card included in the packing material, or detach and use the form in this Owner's Manual.





Dishwashers

Safety Instructions 2, 3

Operating Instructions

Care and Cleaning 9-10

Control Panel and Settings 4-5

Loading the Racks 8

Using the Dishwasher 6-7

Troubleshooting Tips 11-12

Consumer Support

Consumer Support Back Cover

Warranty 15

Owner's Manual

GLDA690

GLDA696

Write the model and serial numbers here:

Model # _____

Serial # _____

You can find them on the tub wall just inside the door.

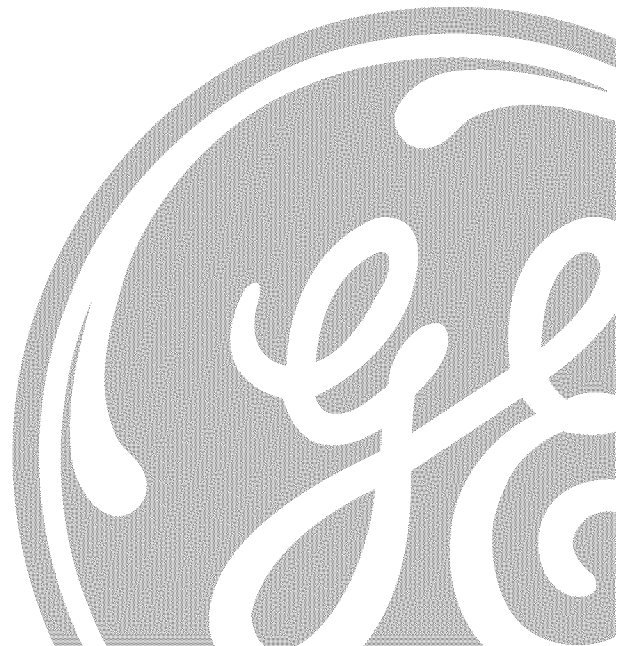

IMPORTANT SAFETY INFORMATION.

READ ALL INSTRUCTIONS BEFORE USING —

SAVE THESE INSTRUCTIONS

▲ WARNING!

For your safety, the information in this manual must be followed to minimize the risk of fire or explosion, electric shock, and to prevent property damage, personal injury, or death.



▲ WARNING! WATER HEATER SAFETY

Under certain conditions, hydrogen gas may be produced in a water heater that has not been used for two weeks or more. **HYDROGEN GAS IS EXPLOSIVE.**

If the hot water has not been used for two weeks or more, prevent the possibility of damage or injury by turning on all hot water faucets and allow them to run for several minutes. Do this before using any electrical appliance which is connected to the hot water system. This simple procedure will allow any built-up hydrogen gas to escape. Since the gas is flammable, do not smoke or use an open flame or appliance during this process.



PROPER INSTALLATION AND MAINTENANCE

This dishwasher must be properly installed and located in accordance with the Installation Instructions before it is used. If you did not receive an Installation Instructions sheet with your dishwasher, you can receive one by visiting our website at ge.com.

- Connect to a grounded metal, permanent wiring system; or run an equipment-grounding conductor with the circuit conductors and connect to the equipment-grounding terminal or lead of the appliance.
- Improper connection of the equipment-grounding conductor can result in a risk of electric shock. Check with a qualified electrician or service representative if you are in doubt whether the appliance is properly grounded.
- Dispose of discarded appliances and shipping or packing material properly.
- Do not attempt to repair or replace any part of your dishwasher unless it is specifically recommended in this manual. All other servicing should be referred to a qualified technician.
- To minimize the possibility of electric shock, disconnect this appliance from the power supply before attempting any maintenance.

NOTE: Turning the dishwasher off does not disconnect the appliance from the power supply. We recommend having a qualified technician service your appliance.

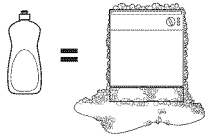
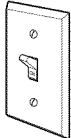

▲ CAUTION: To prevent minor injury or property damage

- Contents washed in Anti-bacterial mode, if available, may be hot to the touch. Use care before handling.
- Using a detergent that is not specifically designed for dishwashers will cause the dishwasher to fill with suds. 
- If your dishwasher is connected to a wall switch, ensure that the switch is on prior to use. 
- On dishwashers with electronic controls, if you choose to turn the wall switch off between wash cycles, allow 5-10 seconds after turning the switch on before touching START/RESET to allow the control to reboot.
- Non-Dishware Items: Do not wash items such as electronic air cleaner filters, furnace filters and paint brushes in your dishwasher. Damage to dishwasher and discoloration or staining of dishwasher may result.
- Close supervision is necessary if this appliance is used by or near children.
- Load light, plastic items so they will not become dislodged and drop to the bottom of the dishwasher—they might come into contact with the heating element and be damaged.

▲ **WARNING! RISK OF CHILD ENTRAPMENT** **PROPER DISPOSAL OF THE DISHWASHER**

Junked or abandoned dishwashers are dangerous... even if they will sit for "just a few days." If you are getting rid of your old dishwasher, please follow the instructions to help prevent accidents.

Before You Throw Away Your Old Dishwasher

Take off the door of the washing compartment or remove the door latch (as shown).

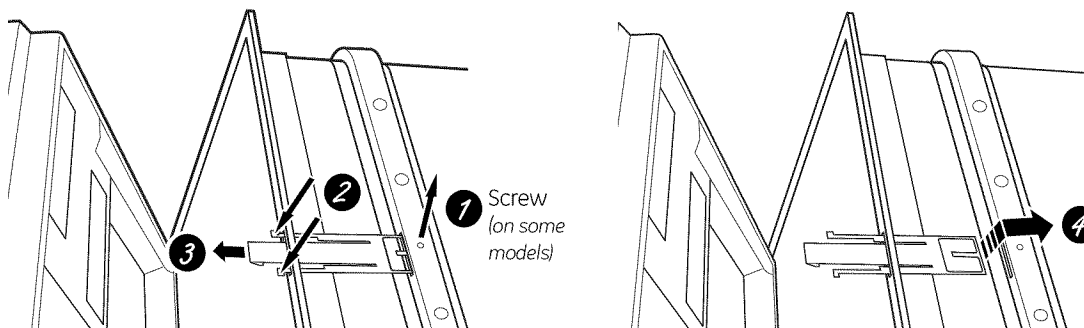

▲ **WARNING!**

When using your dishwasher, follow basic precautions, including the following:

- Use this appliance only for its intended purpose as described in this Owner's Manual.
- Use only powder, tabs, liquid detergents or rinse agents recommended for use in a dishwasher and keep them out of the reach of children. **Cascade®**, **Cascade® Complete** and **Electrasol®** Automatic Dishwashing Detergents, and **Jet-Dry®** and **Cascade Crystal Clear®** rinse agents have been approved for use in all GE dishwashers.
- **Do not mix any chlorine bleach-based automatic dishwashing detergent with any dishwashing detergent containing enzymes as this could cause the detergents to congeal and lead to blockage of the SmartDispense™ system.**
- Locate sharp items so that they are not likely to damage the door seal.
- Load sharp knives with the handles up to reduce the risk of cut-type injuries.
- Do not wash plastic items unless marked dishwasher safe or the equivalent. For plastic items not so marked, check the manufacturer's recommendations.
- Do not touch the heating element during or immediately after use.
- Do not operate your dishwasher unless all enclosure panels are properly in place.
- Do not tamper with controls.
- Do not abuse, sit on or stand on the door or dish rack of the dishwasher.
- Do not allow children to play around dishwasher when opening or closing door due to the possibility of small fingers being pinched in door.
- Do not discard a dishwasher without first removing the door of the washing compartment or the door latch.
- Do not store or use combustible materials, gasoline or other flammable vapors and liquids in the vicinity of this or any other appliance.
- Do not allow children to play with, on or inside this appliance or any discarded appliance.



READ AND FOLLOW THIS SAFETY INFORMATION CAREFULLY.

SAVE THESE INSTRUCTIONS

About the dishwasher control panel.

Throughout this manual, features and appearance may vary from your model.

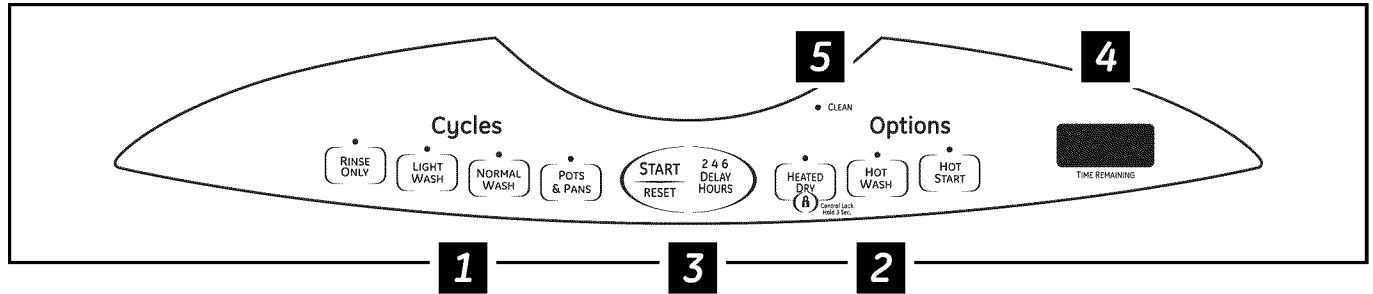

Control Settings

1 Wash Cycles

- POTS & PANS** 7.4 gal., 85 min.
This cycle is meant for heavily soiled dishes or cookware with dried-on or baked-on soils. This cycle may not remove burned-on foods. Everyday dishes are safe to be used in this cycle.
- NORMAL WASH** 5.3 gal., 56 min.
This cycle is for medium/heavily soiled dishes and glassware.
- LIGHT WASH** 4.2 gal., 33 min.
This cycle is for lightly soiled dishes and glassware.
- RINSE ONLY** 2.1 gal., 7 min.
This cycle is for rinsing partial loads that will be washed later.
DO NOT use detergent or HEATED DRY Option with this cycle.

2 Options

The light above the selected pad will be ON to indicate which OPTION has been selected.

- HEATED DRY** Turns the heater on for fast drying. This will extend the total cycle time by approximately 38 minutes for a **NORMAL WASH** cycle.
Light ON
NOTE: Cannot be selected with **RINSE ONLY** cycle.
- HEATED DRY** Shuts off the drying heat option. Dishes will air dry naturally to save energy.
Light OFF
- HOT WASH** When selected, the cycle will run a little longer with heated elements on to improve both wash and dry performance. Adds approximately 15 minutes to the cycle.
NOTE: Cannot be selected with **RINSE ONLY** cycle.
- HOT START** For use with heavily soiled and/or dried-on, baked-on soils. This option **MUST** be selected **PRIOR** to starting the cycle. This option adds approximately 22 minutes to the cycle and two additional rinses to the cycle.
NOTE: Cannot be selected with **RINSE ONLY** cycle.
- LOCK** You can lock the controls to prevent any selections from being made. Or you can lock the controls after you have started a cycle.

Children cannot accidentally start dishwasher by touching pads with this option selected.
To unlock the dishwasher controls, press and hold the **HEATED DRY** pad for 3 seconds. The light above the lock pad will turn off. To lock the dishwasher, press and hold the **HEATED DRY** pad for 3 seconds. The light above the **LOCK** pad will turn on.

3 Start/Reset

Close and latch the dishwasher door and select the cycle and desired enhancements. Touch the **START/RESET** pad to begin the cycle. The water fill begins immediately, and approximately 60 seconds later the wash action begins.

When the dishwasher door is fully closed and latched, the control panel lights will display the last settings you selected. If you don't want to change any of the settings, simply touch the **START/RESET** pad to begin the cycle.

If the door is closed, the indicator lights will turn off if the **START/RESET** pad is not selected within 5 minutes. To activate the display, open and close the door or press any pad.

DELAY HOURS You can delay the start of a wash cycle for up to 6 hours. Press the **DELAY START** pad to choose the number of hours you want to delay the start of the cycle; then press **START/RESET**.

The machine will count down and start automatically at the correct time.

NOTE: To cancel the **DELAY START** selection before the cycle begins, repeatedly press the **DELAY START** pad until the display is blank.

RESET To change a cycle after washing starts:

Touch the **START/RESET** pad to cancel the cycle. The **START/RESET** light will flash while the water is pumped out, if needed. This takes approximately 2 minutes.

4 Time Remaining Display *(on some models)*

During operation, the display shows the minutes remaining until the cycle is complete. The display may adjust the remaining time while the **SENSING** light is on. The time displayed at the start of each cycle may change from the factory setting as the unit customizes itself to home use. During a delay start, the display will show hours of time remaining until the cycle starts.

5 Clean

The **CLEAN** light is illuminated when the selected cycle and enhancements are complete. The light will stay **ON** until a pad is pressed or the door is opened and then closed.

Using the dishwasher.



Check the Water Temperature

The entering water should be at least 120°F and not more than 150°F, for effective cleaning and to prevent dish damage. Check the water temperature with a candy or meat thermometer. Turn on the hot

water faucet nearest the dishwasher, place the thermometer in a glass and let the water run continuously into the glass until the temperature stops rising.



Use Jet-Dry® or Cascade Crystal Clear® Rinse Agent

Jet-Dry® or **Cascade Crystal Clear®** rinse agents remove spots and prevent new film buildup on your dishes, glasses, flatware, cookware and plastic.

Filling the Dispenser

The rinse agent dispenser holds 3.5 oz. of rinse agent. Under normal conditions, this will last approximately one month. Refill when rinse agent is not visible in the indicator. Do not overfill.

- 1 Make sure the dishwasher door is fully open.
- 2 Turn the dispenser cap to the left and lift it out.
- 3 Add rinse agent until the indicator window looks full. Do not overfill.
- 4 Clean up any spilled rinse agent with a damp cloth to prevent foam.
- 5 Replace the dispenser cap.

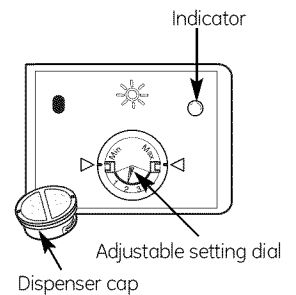

Rinse Aid Setting

The amount of rinse agent released into the final wash can be adjusted. The factory setting is at the midpoint. If there are rings of calcium (hard water) spots on dishes, try a higher setting. If you observe foam in the final rinse, try a lower setting.

To adjust the setting

Remove the dispenser cap, then turn the adjustable setting dial counterclockwise to increase the amount of rinse agent or clockwise to reduce the amount of rinse agent dispensed.

Dish Preparation Prior to Loading

- No pre-rinsing of normal food soil is required.
- Remove leafy vegetables, meat trimmings and excessive amounts of grease or oil.
- Remove acidic food soils that can discolor stainless steel.
- Scrape off hard soils, including bones, toothpicks, skins and seeds.
- Remove large quantities of any remaining food.



Proper Use of Detergent

Use only detergent specifically made for use in dishwashers. **Cascade®** and **Electrasol®** Automatic Dishwashing Detergents have been approved for use in all GE dishwashers. Keep your detergent fresh and dry. Don't put powder detergent into the dispenser until you're ready to wash dishes.

The amount of detergent to use depends on whether your water is *hard* or *soft*. With hard water, you need extra detergent. With soft water, you need less detergent.

Protect your dishes and dishwasher by contacting your water department and asking how hard your water is. Twelve or more grains is extremely hard water. A water softener is recommended. Without it, lime can build up in the water valve, which could stick while open and cause flooding. Too much detergent with soft water can cause a permanent cloudiness of glassware, called *etching*.

Use the information in the table below as a guideline to determine the amount of automatic dishwasher detergent to place in the dispenser.

Number of Grains	Detergent Cups to Fill
Less than 4	15 cup
4 to 8	25 cup
8 to 12	15 and 25 cups
Greater than 12	15, 25 cups and the open cup

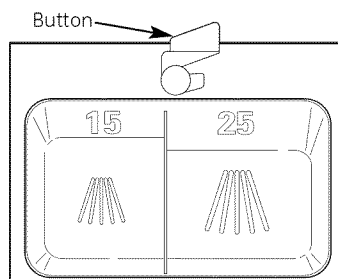
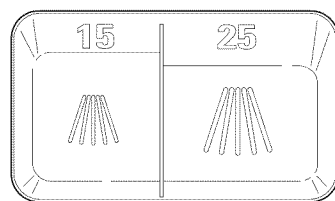

To open the wash cover, press the button and the cover will flip back.

For heavily-soiled loads, use the *Pots and Pans* or *Heavy Wash* cycle and add a little extra detergent.

DO NOT USE HAND DISH DETERGENT

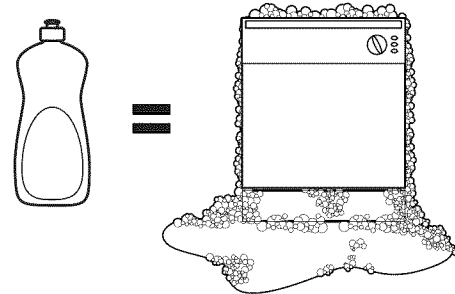

NOTE: Using a detergent that is not specifically designed for dishwashers will cause the dishwasher to fill with suds. During operation, these suds will spill out of the dishwasher vents, covering the kitchen floor and making the floor wet.

Because so many detergent containers look alike, store the dishwasher detergent in a separate space from all other cleaners. Show anyone who may use the dishwasher the correct detergent and where it is stored.

While there will be no lasting damage to the dishwasher, your dishes will not get clean using a dishwashing detergent that is not formulated to work with dishwashers.



Forget to Add a Dish?

A forgotten dish can be added any time before the main wash.

- 1 Squeeze the door latch to release the door.
- 2 Do not open the door until the water spray action stops. Steam may rise out of the dishwasher.

- 3 Add forgotten dishes.
- 4 Close the door.

Loading the dishwasher racks.

For best dishwashing results, follow these loading guidelines. Features and appearance of racks and silverware baskets may vary from your model.

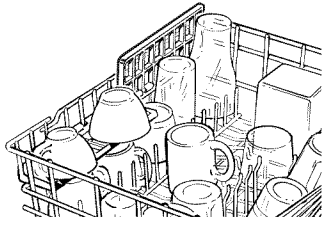

Upper Rack

Although the upper rack is for glasses, cups and saucers, pots and pans can be placed in this rack for effective cleaning. Cups and glasses fit best along the sides. This is also a secure place for dishwasher-safe plastics.

The upper rack is good for all kinds of odd-shaped utensils. Saucepans, mixing bowls and other items should be placed face down. Fold-down tines (on some models) provide flexibility for extra-large and hard-to-fit items.

Secure larger dishwasher-safe plastics over 2 tines when possible.

Make sure small plastic items are secure so they can't fall onto the heater.

Be sure that items do not protrude through the bottom of the rack and block rotation of the middle spray arm. This could result in poor wash performance for items in the upper rack.

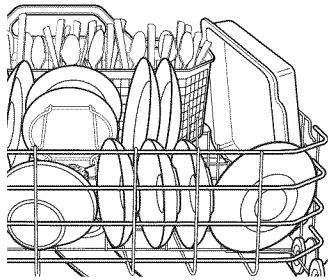

Lower Rack

The lower rack is best used for plates, saucers and cookware. Large items such as broiler pans and baking racks should go along the left-hand side. Load platters, pots and bowls along the sides, in corners or in the back. The soiled side of items should face the center of the rack. If necessary, oversized glasses and mugs can be placed in the lower rack to maximize loading flexibility.

Also, be careful not to let a portion of an item such as a pot or dish handle extend through the bottom rack. This could block the wash arm and cause poor washing results.

Fold-down tines (on some models) provide flexibility for extra-large and hard-to-fit items. The tines may be left in the up position or folded down to customize the lower rack.

Three-piece basket

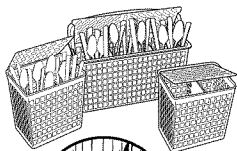

Don't let any item extend through bottom.

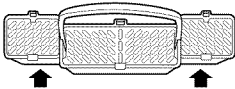

To remove end baskets, grasp the basket at opposite corners and slide apart.

Silverware Basket

To load flatware, simply push the adjustable handle to either side. Put flatware in the removable basket with fork and knife handles up to protect your hands. Place spoons in the basket with handles down. Mix knives, forks and spoons so they don't nest together. Distribute evenly. Small plastic items, such as measuring spoons and lids from small containers should go in the bottom of the silverware basket with the silverware on top.

A variety of options is available regarding the three-piece silverware basket in your dishwasher. The complete basket is designed to fit on the right side of the lower rack. Additionally, each end of the basket is removable to add loading flexibility to accommodate flatware and lower rack capacity needs.

The lids of both end and middle baskets (on some models) can be closed to contain small items. Long items can be placed on the utility shelf in the upper rack.

Cleaning the Exterior Door Panel

Before cleaning the front panel, make sure you know what type of panel you have. Refer to the last two letters of your model number. You can locate your model number on the left-hand tub wall just inside the door. If your model number ends with BB, WW or CC, then you have a Painted Door panel. If your model number ends with SS, then you have a Stainless Steel Door panel. If your model number ends with CS, then you have a CleanSteel Door panel.

Follow the instructions below for cleaning the door panel for your specific model.

Painted Door Panel (model numbers ending in BB–black, WW–white or CC–bisque)

Use a clean, soft, lightly dampened cloth, then dry thoroughly. You may also use a good appliance wax or polish.

Stainless Steel Door Panel (model numbers ending in SS)

The stainless steel panels can be cleaned with *Stainless Steel Magic* or a similar product using a clean, soft cloth. Do not use appliance wax, polish, bleach or products containing chlorine on Stainless Steel doors.

You can order *Stainless Steel Magic* #WX10X15 through GE Parts by calling 800.626.2002.

CleanSteel Door Panel (model numbers ending in CS)

Use a clean, soft, lightly dampened cloth, then dry thoroughly. Do not use appliance wax, polish or any chemical agent on CleanSteel doors.

Do not wipe the dishwasher with a soiled dish cloth or wet towel. These may leave a residue. Do not use scouring pads or powdered cleaners because these products can scratch the finish.

Cleaning the Control Panel

To clean the control panel, use a lightly dampened cloth. Then dry thoroughly.

Stainless Steel Interior—Tub and Inner Door

The stainless steel used to make the dishwasher tub and inner door provides the highest reliability available in a GE dishwasher. If the dishwasher tub or inner door should be scratched or dented during normal use, they will not rust or corrode. These surface blemishes will not affect their function or durability.

Caring for the dishwasher.

Spray Arms and Filters

The dishwasher will flush away all normal food soils. However, objects (fruit pits, bones, etc.) may collect in openings and should be removed occasionally to avoid clogging the drain system.

▲ CAUTION: *Personal injury hazard. Before cleaning the interior, wait at least 20 minutes after a cycle for the heating element to cool down. Failure to do so could result in burn injuries.*

Cleaning the Spray Arms

Because hard water chemicals will clog the spray arm jets and bearings, it is necessary to clean the spray arms regularly. To remove the spray arm, twist the retaining nut 90 degrees and pull the spray arm off the shaft.

Wash the arms in soapy, warm water and use a soft brush to clean the jets. Replace them after rinsing thoroughly.

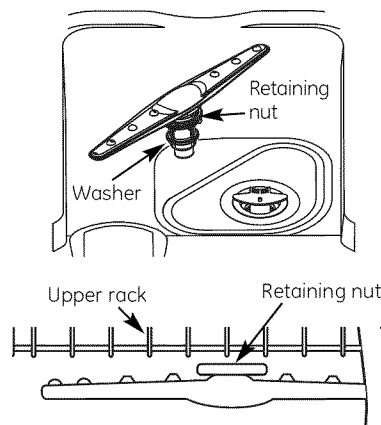

Cleaning the Filters

For best performance and results, the filter assembly must be cleaned regularly. The filter efficiently removes food particles from the wash water, allowing water to be recirculated during the cycle. For this reason, it is a good idea to remove the large food particles trapped in the filter frequently by rinsing the main filter and cup under running water. To remove the filter assembly, pull up on the cup handle. The entire filter assembly should be cleaned at least once a month. To clean the main filter and fine filter, use a cleaning brush. Then, reassemble the filter parts as shown in the illustration and reinsert the entire assembly in the dishwasher, positioning it in place and pressing downward. The dishwasher must never be used without the filters. Improper replacement of the filter may reduce the performance level of the appliance and may damage dishes and utensils.

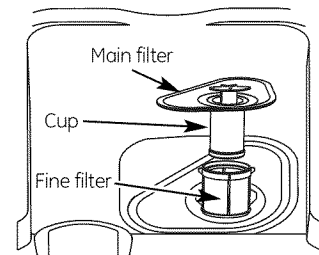

Protect Against Freezing

If your dishwasher is left in an unheated place during the winter, ask a service technician to:

- 1 Cut off electrical power to the dishwasher. Remove fuses or trip circuit breaker.
- 2 Turn off the water supply and disconnect the water inlet line from the water valve.

- 3 Drain water from the water inlet line and water valve. (Use a pan to catch the water.)
- 4 Reconnect the water inlet line to the water valve.

Does Your Dishwasher Have an Air Gap?

An air gap protects your dishwasher against water backing up into it if a drain clogs. The air gap is not a part of the dishwasher. It is not covered by your warranty. Not all plumbing codes require air gaps, so you may not have one.

The air gap is easy to clean.

- 1 Turn off the dishwasher and lift off the cover.
- 2 Remove the plastic cap and clean with a toothpick.

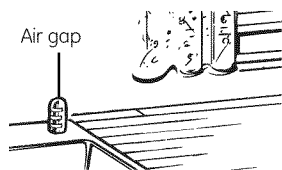

Check the air gap any time your dishwasher isn't draining well.

Before you call for service...

ge.com



Troubleshooting Tips
Save time and money! Review the charts on the following pages, or visit ge.com. You may not need to call for service.

Problem	Possible Causes	What To Do
Dishes and flatware not clean	Low inlet water temperature	<ul style="list-style-type: none"> Make sure inlet water temperature is correct (see page 6). Turn on the hot water faucet nearest the dishwasher, let run until the water temperature stops rising. Then start the dishwasher and turn off the faucet. This insures the entering water is hot.
	Water pressure is temporarily low	<ul style="list-style-type: none"> Turn on a faucet. Is water coming out more slowly than usual? If so, wait until pressure is normal before using your dishwasher.
	Air gap or disposer is clogged	<ul style="list-style-type: none"> Clean the air gap or flush the disposer.
	Improper rack loading	<ul style="list-style-type: none"> Make sure large dishware does not block the detergent dispenser or the wash arms. See the <i>Loading the dishwasher racks</i> section.
	No air gap or high drain loop	<ul style="list-style-type: none"> Verify that you have an air gap or a high drain loop. Refer to the Installation Instructions.
Spots and filming on glasses and flatware	Extremely hard water	<ul style="list-style-type: none"> Use <i>Jet-Dry</i>[®] or <i>Cascade Crystal Clear</i>[®] rinse agents to remove spots and prevent new film buildup.
	Low inlet water temperature Overloading the dishwasher Improper loading Old or damp powder detergent Rinse agent dispenser empty Too little detergent	<ul style="list-style-type: none"> To remove stubborn spots and pre-existing film from glassware: <ol style="list-style-type: none"> Remove all metal utensils from the dishwasher. Do not add detergent. Select the <i>POTS & PANS</i> cycle. Start the dishwasher and allow to run for 18 to 22 minutes. Dishwasher will now be in the main wash. Open the door and pour 2 cups (500 ml) of white vinegar into the bottom of the dishwasher. Close the door and allow to complete the cycle. If vinegar rinse doesn't work: Repeat as above, except use 1/4 cup (60 ml) of citric acid crystals instead of vinegar.
Cloudiness on glassware	Combination of soft water and too much detergent	<ul style="list-style-type: none"> This is called <i>etching</i> and is permanent. To prevent this from happening, use less detergent if you have soft water. Wash glassware in the shortest cycle that will get them clean.
	Water temperature entering the dishwasher exceeds 150°F	<ul style="list-style-type: none"> This could be etching. Lower the water heater temperature.
Suds in the tub	Correct detergent wasn't used	<ul style="list-style-type: none"> Use only automatic dishwasher detergents to avoid sudsing. <i>Cascade</i>[®] and <i>Electrasol</i>[®] Automatic Dishwashing Detergents have been approved for use in all GE dishwashers. To remove suds from the tub, open the dishwasher and let suds dissipate. Close and latch the dishwasher. Pump out water by touching the <i>START/RESET</i> pad once; then 30 seconds later, touch the <i>START/RESET</i> pad again. Repeat if necessary.
	Rinse agent was spilled	<ul style="list-style-type: none"> Always wipe up rinse agent spills immediately.

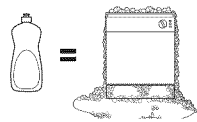

Safety Instructions

Operating Instructions

Troubleshooting Tips

Consumer Support

Before you call for service...

Problem	Possible Causes	What To Do
Detergent left in dispenser cups	Dishes are blocking the detergent cup	<ul style="list-style-type: none"> Reposition the dishes, so the water from the lower spray arm can flush the detergent cup. See the <i>Loading the dishwasher</i> section.
Black or gray marks on dishes	Aluminum utensils have rubbed against dishes	<ul style="list-style-type: none"> Remove marks with a mild, abrasive cleaner.
Dishes don't dry	Low inlet water temperature	<ul style="list-style-type: none"> Make sure inlet water temperature is at least 120°F. Select HEATED DRY. Use HOT START, HOT WASH or ADDED HEAT options. Select a higher cycle, such as POTS & PANS.
	Rinse agent dispenser is empty	<ul style="list-style-type: none"> Check the rinse agent dispenser and fill as required.
Control panel responded to inputs but dishwasher never filled with water	Door latch may not be properly seated	<ul style="list-style-type: none"> Make sure the door is firmly closed.
	Water valve may be turned off	<ul style="list-style-type: none"> Make sure water valve (usually located under the sink) is turned on.
Stained tub interior	Some tomato-based foods can cause reddish stains	<ul style="list-style-type: none"> Use of the RINSE ONLY cycle after adding the dish to the load can decrease the level of staining. GE recommends Cascade® Plastic Booster to help remove these types of stains.
	Tea or coffee stains	<ul style="list-style-type: none"> Remove the stain by hand, using a solution of 1/2 cup bleach and 3 cups warm water. <p>▲ WARNING Before cleaning interior, wait at least 20 minutes after a cycle for the heating elements to cool down. Failure to do so can result in burns.</p>
	An overall yellow or brown film can be caused by iron deposits in water	<ul style="list-style-type: none"> A special filter in the water supply line is the only way to correct this problem. Contact a water softener company.
	White film on inside surface—hard water minerals	<ul style="list-style-type: none"> GE recommends Jet-Dry® or Cascade Crystal Clear® to help prevent hard water mineral deposits from forming. Run dishwasher with citric acid to remove mineral deposits. Citric acid (Part number: WD35X151) can be ordered through GE Parts. See back cover for ordering information.
Dishwasher won't run	Fuse is blown or circuit breaker is tripped	<ul style="list-style-type: none"> Replace fuse or reset circuit breaker. Remove any other appliances from the circuit.
	Power is turned off	<ul style="list-style-type: none"> In some installations, the power to the dishwasher is provided through a wall switch, often located next to the disposer switch. Make sure it is on.
	Control panel is locked	<ul style="list-style-type: none"> Unlock control panel. See page 4.
	Reboot your control	<ul style="list-style-type: none"> Turn off power to the dishwasher (circuit breaker or wall switch) for 30 seconds; then turn back on.
Control panel lights go off when you're setting controls	Time too long between touching of selected pads	<ul style="list-style-type: none"> Each pad must be touched within 30 seconds of the others. To relight, touch any pad again, or unlock and relatch door.
Water standing in the bottom of the tub	This is normal	<ul style="list-style-type: none"> A small amount of clean water around the outlet on the tub bottom at the back of the tub keeps the water seal lubricated.
Water won't pump out of the tub	Drain is clogged	<ul style="list-style-type: none"> If you have an air gap, clean it. See page 10. If the dishwasher drains into a disposer, run disposer clear. Check to see if your kitchen sink is draining well. If not, you may need a plumber.
Steam	This is normal	<ul style="list-style-type: none"> Warm, moist air comes through the vent by the door latch during drying and when water is being pumped out. This is necessary for drying.
Sanitized light does not illuminate at the end of the cycle (Anti-Bacteria cycle only)	The door was opened and the cycle was interrupted during or after the main wash portion	<ul style="list-style-type: none"> Do not interrupt the cycle anytime during or after main wash.
	The incoming water temperature was too low	<ul style="list-style-type: none"> Raise the water heater temperature to between 120°F and 140°F.
Noise	Normal operating sounds	<ul style="list-style-type: none"> Detergent cup opening. Water entering dishwasher. The motor stops and starts at various times during the cycle. Drain pump sounds during the pump out.
	Rattling dishes when the spray arm rotates	<ul style="list-style-type: none"> Make sure dishes are properly loaded. See the <i>Loading the dishwasher racks</i> section.

Notes.

<i>Safety Instructions</i>	<i>Operating Instructions</i>	<i>Troubleshooting Tips</i>	<i>Consumer Support</i>
----------------------------	-------------------------------	-----------------------------	-------------------------

Notes.

Safety Instructions

Operating Instructions

Troubleshooting Tips

Consumer Support

GE Dishwasher Warranty.



All warranty service provided by our Factory Service Centers, or an authorized Customer Care[®] technician. To schedule service, on-line, 24 hours a day, visit us at ge.com, or call 800.GE.CARES (800.432.2737). Please have serial number and model number available when calling for service.

Staple your receipt here.
Proof of the original purchase date is needed to obtain service under the warranty.

For The Period Of: GE Will Replace:

One Year

From the date of the original purchase

Any part of the dishwasher which fails due to a defect in materials or workmanship. During this **limited one-year warranty**, GE will also provide, **free of charge**, all labor and related service to replace the defective part.

What GE Will Not Cover:

- Service trips to your home to teach you how to use the product.
- Improper installation, delivery or maintenance.
- Failure of the product if it is abused, misused, or used for other than the intended purpose or used commercially.
- Replacement of house fuses or resetting of circuit breakers.
- Damage to the product caused by accident, fire, floods or acts of God.
- Incidental or consequential damage caused by possible defects with this appliance.
- Cleaning or servicing of the air gap device in the drain line.
- Damage caused after delivery.
- Product not accessible to provide required service.

EXCLUSION OF IMPLIED WARRANTIES—Your sole and exclusive remedy is product repair as provided in this Limited Warranty. Any implied warranties, including the implied warranties of merchantability or fitness for a particular purpose, are limited to one year or the shortest period allowed by law.

This warranty is extended to the original purchaser and any succeeding owner for products purchased for home use within the USA. If the product is located in an area where service by a GE Authorized Servicer is not available, you may be responsible for a trip charge or you may be required to bring the product to an Authorized GE Service location for service. Proof of original purchase date is needed to obtain service under the warranty. In Alaska, the warranty excludes the cost of shipping or service calls to your home.

Some states do not allow the exclusion or limitation of incidental or consequential damages. This warranty gives you specific legal rights, and you may also have other rights which vary from state to state. To know what your legal rights are, consult your local or state consumer affairs office or your state's Attorney General.

Warrantor: General Electric Company. Louisville, KY 40225

Consumer Support.



GE Appliances Website

ge.com

Have a question or need assistance with your appliance? Try the GE Appliances Website 24 hours a day, any day of the year! For greater convenience and faster service, you can now download Owner's Manuals, order parts or even schedule service on-line.

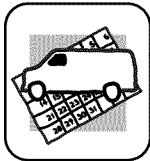

Schedule Service

ge.com

Expert GE repair service is only one step away from your door. Get on-line and schedule your service at your convenience 24 hours any day of the year! Or call 800.GE.CARES (800.432.2737) during normal business hours.

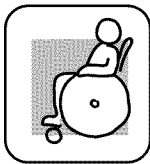

Real Life Design Studio

ge.com

GE supports the Universal Design concept—products, services and environments that can be used by people of all ages, sizes and capabilities. We recognize the need to design for a wide range of physical and mental abilities and impairments. For details of GE's Universal Design applications, including kitchen design ideas for people with disabilities, check out our Website today. For the hearing impaired, please call 800.TDD.GEAC (800.833.4322).



Extended Warranties

ge.com

Purchase a GE extended warranty and learn about special discounts that are available while your warranty is still in effect. You can purchase it on-line anytime, or call 800.626.2224 during normal business hours. GE Consumer Home Services will still be there after your warranty expires.

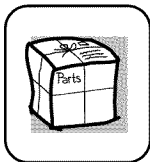

Parts and Accessories

ge.com

Individuals qualified to service their own appliances can have parts or accessories sent directly to their homes (VISA, MasterCard and Discover cards are accepted). Order on-line today, 24 hours every day or by phone at 800.626.2002 during normal business hours.

Instructions contained in this manual cover procedures to be performed by any user. Other servicing generally should be referred to qualified service personnel. Caution must be exercised, since improper servicing may cause unsafe operation.



Contact Us

ge.com

If you are not satisfied with the service you receive from GE, contact us on our Website with all the details including your phone number, or write to:

General Manager, Customer Relations
GE Appliances, Appliance Park
Louisville, KY 40225



Register Your Appliance

ge.com

Register your new appliance on-line—at your convenience! Timely product registration will allow for enhanced communication and prompt service under the terms of your warranty, should the need arise. You may also mail in the pre-printed registration card included in the packing material, or detach and use the form in this Owner's Manual.





Dishwashers

Safety Instructions 2, 3

Operating Instructions

Care and Cleaning 9-10

Control Panel and Settings 4-5

Loading the Racks 8

Using the Dishwasher 6-7

Troubleshooting Tips 11-12

Consumer Support

Consumer Support Back Cover

Warranty 15

Owner's Manual

GLDA690

GLDA696

Write the model and serial numbers here:

Model # _____

Serial # _____

You can find them on the tub wall just inside the door.

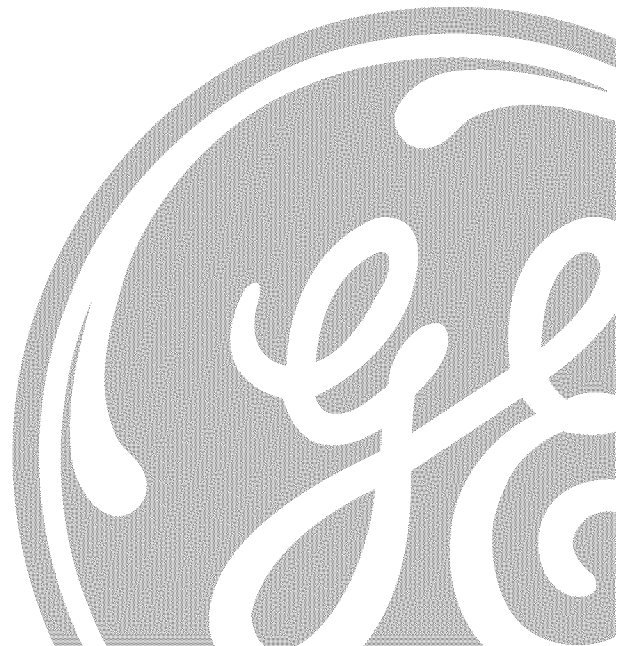

IMPORTANT SAFETY INFORMATION.

READ ALL INSTRUCTIONS BEFORE USING —

SAVE THESE INSTRUCTIONS

▲ WARNING!

For your safety, the information in this manual must be followed to minimize the risk of fire or explosion, electric shock, and to prevent property damage, personal injury, or death.



▲ WARNING! WATER HEATER SAFETY

Under certain conditions, hydrogen gas may be produced in a water heater that has not been used for two weeks or more. **HYDROGEN GAS IS EXPLOSIVE.**

If the hot water has not been used for two weeks or more, prevent the possibility of damage or injury by turning on all hot water faucets and allow them to run for several minutes. Do this before using any electrical appliance which is connected to the hot water system. This simple procedure will allow any built-up hydrogen gas to escape. Since the gas is flammable, do not smoke or use an open flame or appliance during this process.



PROPER INSTALLATION AND MAINTENANCE

This dishwasher must be properly installed and located in accordance with the Installation Instructions before it is used. If you did not receive an Installation Instructions sheet with your dishwasher, you can receive one by visiting our website at ge.com.

- Connect to a grounded metal, permanent wiring system; or run an equipment-grounding conductor with the circuit conductors and connect to the equipment-grounding terminal or lead of the appliance.
- Improper connection of the equipment-grounding conductor can result in a risk of electric shock. Check with a qualified electrician or service representative if you are in doubt whether the appliance is properly grounded.
- Dispose of discarded appliances and shipping or packing material properly.
- Do not attempt to repair or replace any part of your dishwasher unless it is specifically recommended in this manual. All other servicing should be referred to a qualified technician.
- To minimize the possibility of electric shock, disconnect this appliance from the power supply before attempting any maintenance.

NOTE: Turning the dishwasher off does not disconnect the appliance from the power supply. We recommend having a qualified technician service your appliance.

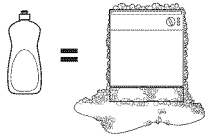
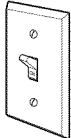

▲ CAUTION: To prevent minor injury or property damage

- Contents washed in Anti-bacterial mode, if available, may be hot to the touch. Use care before handling.
- Using a detergent that is not specifically designed for dishwashers will cause the dishwasher to fill with suds. 
- If your dishwasher is connected to a wall switch, ensure that the switch is on prior to use. 
- On dishwashers with electronic controls, if you choose to turn the wall switch off between wash cycles, allow 5-10 seconds after turning the switch on before touching START/RESET to allow the control to reboot.
- Non-Dishware Items: Do not wash items such as electronic air cleaner filters, furnace filters and paint brushes in your dishwasher. Damage to dishwasher and discoloration or staining of dishwasher may result.
- Close supervision is necessary if this appliance is used by or near children.
- Load light, plastic items so they will not become dislodged and drop to the bottom of the dishwasher—they might come into contact with the heating element and be damaged.

▲ **WARNING! RISK OF CHILD ENTRAPMENT** **PROPER DISPOSAL OF THE DISHWASHER**

Junked or abandoned dishwashers are dangerous... even if they will sit for "just a few days." If you are getting rid of your old dishwasher, please follow the instructions to help prevent accidents.

Before You Throw Away Your Old Dishwasher

Take off the door of the washing compartment or remove the door latch (as shown).

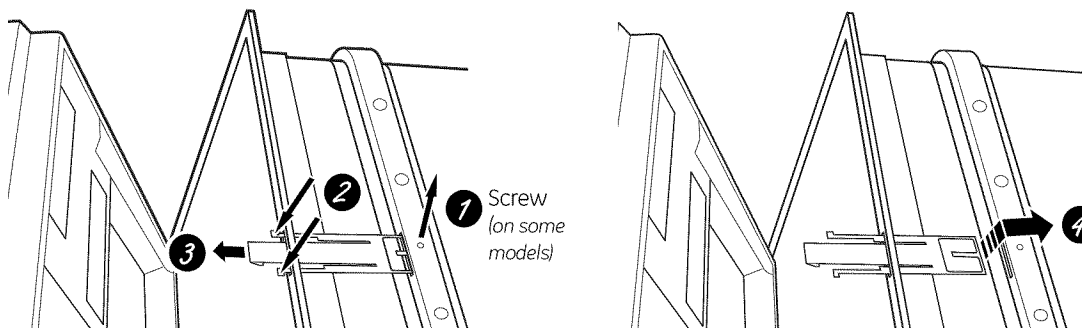

▲ **WARNING!**

When using your dishwasher, follow basic precautions, including the following:

- Use this appliance only for its intended purpose as described in this Owner's Manual.
- Use only powder, tabs, liquid detergents or rinse agents recommended for use in a dishwasher and keep them out of the reach of children. **Cascade®**, **Cascade® Complete** and **Electrasol®** Automatic Dishwashing Detergents, and **Jet-Dry®** and **Cascade Crystal Clear®** rinse agents have been approved for use in all GE dishwashers.
- **Do not mix any chlorine bleach-based automatic dishwashing detergent with any dishwashing detergent containing enzymes as this could cause the detergents to congeal and lead to blockage of the SmartDispense™ system.**
- Locate sharp items so that they are not likely to damage the door seal.
- Load sharp knives with the handles up to reduce the risk of cut-type injuries.
- Do not wash plastic items unless marked dishwasher safe or the equivalent. For plastic items not so marked, check the manufacturer's recommendations.
- Do not touch the heating element during or immediately after use.
- Do not operate your dishwasher unless all enclosure panels are properly in place.
- Do not tamper with controls.
- Do not abuse, sit on or stand on the door or dish rack of the dishwasher.
- Do not allow children to play around dishwasher when opening or closing door due to the possibility of small fingers being pinched in door.
- Do not discard a dishwasher without first removing the door of the washing compartment or the door latch.
- Do not store or use combustible materials, gasoline or other flammable vapors and liquids in the vicinity of this or any other appliance.
- Do not allow children to play with, on or inside this appliance or any discarded appliance.



READ AND FOLLOW THIS SAFETY INFORMATION CAREFULLY.

SAVE THESE INSTRUCTIONS

About the dishwasher control panel.

Throughout this manual, features and appearance may vary from your model.

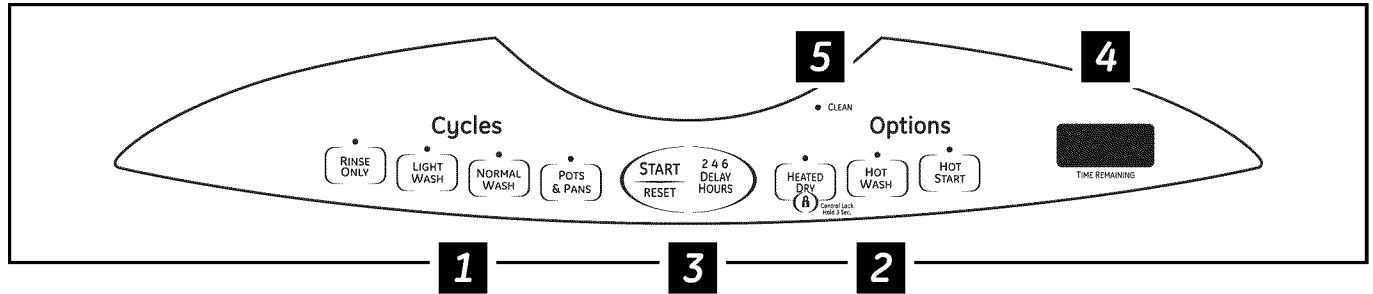

Control Settings

1 Wash Cycles

- POTS & PANS** 7.4 gal., 85 min.
This cycle is meant for heavily soiled dishes or cookware with dried-on or baked-on soils. This cycle may not remove burned-on foods. Everyday dishes are safe to be used in this cycle.
- NORMAL WASH** 5.3 gal., 56 min.
This cycle is for medium/heavily soiled dishes and glassware.
- LIGHT WASH** 4.2 gal., 33 min.
This cycle is for lightly soiled dishes and glassware.
- RINSE ONLY** 2.1 gal., 7 min.
This cycle is for rinsing partial loads that will be washed later.
DO NOT use detergent or HEATED DRY Option with this cycle.

2 Options

The light above the selected pad will be ON to indicate which OPTION has been selected.

- HEATED DRY** Turns the heater on for fast drying. This will extend the total cycle time by approximately 38 minutes for a **NORMAL WASH** cycle.
Light ON
NOTE: Cannot be selected with **RINSE ONLY** cycle.
- HEATED DRY** Shuts off the drying heat option. Dishes will air dry naturally to save energy.
Light OFF
- HOT WASH** When selected, the cycle will run a little longer with heated elements on to improve both wash and dry performance. Adds approximately 15 minutes to the cycle.
NOTE: Cannot be selected with **RINSE ONLY** cycle.
- HOT START** For use with heavily soiled and/or dried-on, baked-on soils. This option **MUST** be selected **PRIOR** to starting the cycle. This option adds approximately 22 minutes to the cycle and two additional rinses to the cycle.
NOTE: Cannot be selected with **RINSE ONLY** cycle.
- LOCK** You can lock the controls to prevent any selections from being made. Or you can lock the controls after you have started a cycle.

Children cannot accidentally start dishwasher by touching pads with this option selected.
To unlock the dishwasher controls, press and hold the **HEATED DRY** pad for 3 seconds. The light above the lock pad will turn off. To lock the dishwasher, press and hold the **HEATED DRY** pad for 3 seconds. The light above the **LOCK** pad will turn on.

3 Start/Reset

Close and latch the dishwasher door and select the cycle and desired enhancements. Touch the **START/RESET** pad to begin the cycle. The water fill begins immediately, and approximately 60 seconds later the wash action begins.

When the dishwasher door is fully closed and latched, the control panel lights will display the last settings you selected. If you don't want to change any of the settings, simply touch the **START/RESET** pad to begin the cycle.

If the door is closed, the indicator lights will turn off if the **START/RESET** pad is not selected within 5 minutes. To activate the display, open and close the door or press any pad.

DELAY HOURS You can delay the start of a wash cycle for up to 6 hours. Press the **DELAY START** pad to choose the number of hours you want to delay the start of the cycle; then press **START/RESET**.

The machine will count down and start automatically at the correct time.

NOTE: To cancel the **DELAY START** selection before the cycle begins, repeatedly press the **DELAY START** pad until the display is blank.

RESET To change a cycle after washing starts:

Touch the **START/RESET** pad to cancel the cycle. The **START/RESET** light will flash while the water is pumped out, if needed. This takes approximately 2 minutes.

4 Time Remaining Display *(on some models)*

During operation, the display shows the minutes remaining until the cycle is complete. The display may adjust the remaining time while the **SENSING** light is on. The time displayed at the start of each cycle may change from the factory setting as the unit customizes itself to home use. During a delay start, the display will show hours of time remaining until the cycle starts.

5 Clean

The **CLEAN** light is illuminated when the selected cycle and enhancements are complete. The light will stay **ON** until a pad is pressed or the door is opened and then closed.

Using the dishwasher.



Check the Water Temperature

The entering water should be at least 120°F and not more than 150°F, for effective cleaning and to prevent dish damage. Check the water temperature with a candy or meat thermometer. Turn on the hot

water faucet nearest the dishwasher, place the thermometer in a glass and let the water run continuously into the glass until the temperature stops rising.



Use Jet-Dry® or Cascade Crystal Clear® Rinse Agent

Jet-Dry® or **Cascade Crystal Clear®** rinse agents remove spots and prevent new film buildup on your dishes, glasses, flatware, cookware and plastic.

Filling the Dispenser

The rinse agent dispenser holds 3.5 oz. of rinse agent. Under normal conditions, this will last approximately one month. Refill when rinse agent is not visible in the indicator. Do not overfill.

- 1 Make sure the dishwasher door is fully open.
- 2 Turn the dispenser cap to the left and lift it out.
- 3 Add rinse agent until the indicator window looks full. Do not overfill.
- 4 Clean up any spilled rinse agent with a damp cloth to prevent foam.
- 5 Replace the dispenser cap.

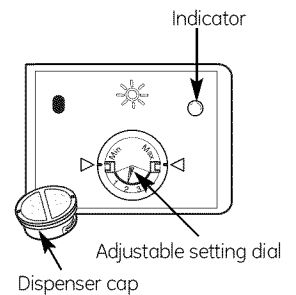

Rinse Aid Setting

The amount of rinse agent released into the final wash can be adjusted. The factory setting is at the midpoint. If there are rings of calcium (hard water) spots on dishes, try a higher setting. If you observe foam in the final rinse, try a lower setting.

To adjust the setting

Remove the dispenser cap, then turn the adjustable setting dial counterclockwise to increase the amount of rinse agent or clockwise to reduce the amount of rinse agent dispensed.

Dish Preparation Prior to Loading

- No pre-rinsing of normal food soil is required.
- Remove leafy vegetables, meat trimmings and excessive amounts of grease or oil.
- Remove acidic food soils that can discolor stainless steel.
- Scrape off hard soils, including bones, toothpicks, skins and seeds.
- Remove large quantities of any remaining food.



Proper Use of Detergent

Use only detergent specifically made for use in dishwashers. **Cascade®** and **Electrasol®** Automatic Dishwashing Detergents have been approved for use in all GE dishwashers. Keep your detergent fresh and dry. Don't put powder detergent into the dispenser until you're ready to wash dishes.

The amount of detergent to use depends on whether your water is *hard* or *soft*. With hard water, you need extra detergent. With soft water, you need less detergent.

Protect your dishes and dishwasher by contacting your water department and asking how hard your water is. Twelve or more grains is extremely hard water. A water softener is recommended. Without it, lime can build up in the water valve, which could stick while open and cause flooding. Too much detergent with soft water can cause a permanent cloudiness of glassware, called *etching*.

Use the information in the table below as a guideline to determine the amount of automatic dishwasher detergent to place in the dispenser.

Number of Grains	Detergent Cups to Fill
Less than 4	15 cup
4 to 8	25 cup
8 to 12	15 and 25 cups
Greater than 12	15, 25 cups and the open cup

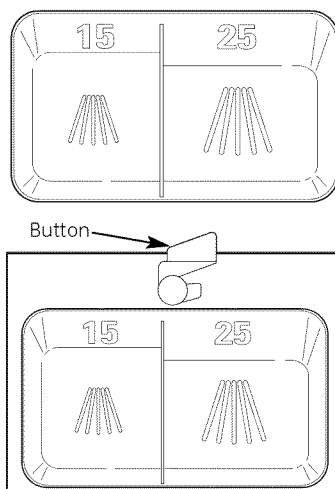

To open the wash cover, press the button and the cover will flip back.

For heavily-soiled loads, use the *Pots and Pans* or *Heavy Wash* cycle and add a little extra detergent.

DO NOT USE HAND DISH DETERGENT

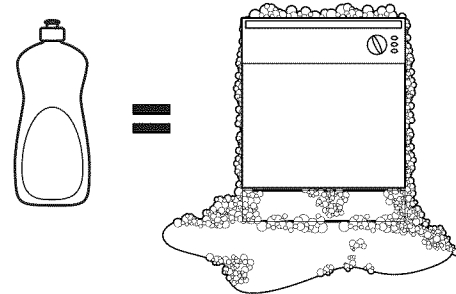

NOTE: Using a detergent that is not specifically designed for dishwashers will cause the dishwasher to fill with suds. During operation, these suds will spill out of the dishwasher vents, covering the kitchen floor and making the floor wet.

Because so many detergent containers look alike, store the dishwasher detergent in a separate space from all other cleaners. Show anyone who may use the dishwasher the correct detergent and where it is stored.

While there will be no lasting damage to the dishwasher, your dishes will not get clean using a dishwashing detergent that is not formulated to work with dishwashers.



Forget to Add a Dish?

A forgotten dish can be added any time before the main wash.

- 1 Squeeze the door latch to release the door.
- 2 Do not open the door until the water spray action stops. Steam may rise out of the dishwasher.

- 3 Add forgotten dishes.
- 4 Close the door.

Loading the dishwasher racks.

For best dishwashing results, follow these loading guidelines. Features and appearance of racks and silverware baskets may vary from your model.

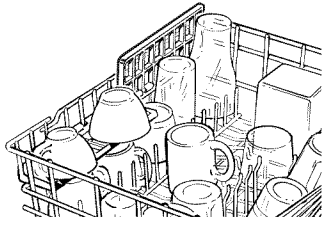

Upper Rack

Although the upper rack is for glasses, cups and saucers, pots and pans can be placed in this rack for effective cleaning. Cups and glasses fit best along the sides. This is also a secure place for dishwasher-safe plastics.

The upper rack is good for all kinds of odd-shaped utensils. Saucepans, mixing bowls and other items should be placed face down. Fold-down tines (on some models) provide flexibility for extra-large and hard-to-fit items.

Secure larger dishwasher-safe plastics over 2 tines when possible.

Make sure small plastic items are secure so they can't fall onto the heater.

Be sure that items do not protrude through the bottom of the rack and block rotation of the middle spray arm. This could result in poor wash performance for items in the upper rack.

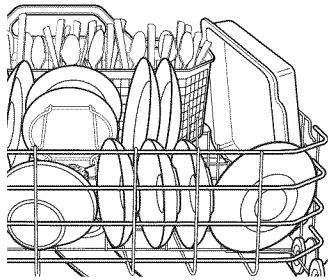

Lower Rack

The lower rack is best used for plates, saucers and cookware. Large items such as broiler pans and baking racks should go along the left-hand side. Load platters, pots and bowls along the sides, in corners or in the back. The soiled side of items should face the center of the rack. If necessary, oversized glasses and mugs can be placed in the lower rack to maximize loading flexibility.

Also, be careful not to let a portion of an item such as a pot or dish handle extend through the bottom rack. This could block the wash arm and cause poor washing results.

Fold-down tines (on some models) provide flexibility for extra-large and hard-to-fit items. The tines may be left in the up position or folded down to customize the lower rack.

Three-piece basket

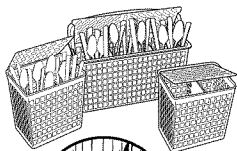

Don't let any item extend through bottom.

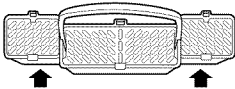

To remove end baskets, grasp the basket at opposite corners and slide apart.

Silverware Basket

To load flatware, simply push the adjustable handle to either side. Put flatware in the removable basket with fork and knife handles up to protect your hands. Place spoons in the basket with handles down. Mix knives, forks and spoons so they don't nest together. Distribute evenly. Small plastic items, such as measuring spoons and lids from small containers should go in the bottom of the silverware basket with the silverware on top.

A variety of options is available regarding the three-piece silverware basket in your dishwasher. The complete basket is designed to fit on the right side of the lower rack. Additionally, each end of the basket is removable to add loading flexibility to accommodate flatware and lower rack capacity needs.

The lids of both end and middle baskets (on some models) can be closed to contain small items. Long items can be placed on the utility shelf in the upper rack.

Cleaning the Exterior Door Panel

Before cleaning the front panel, make sure you know what type of panel you have. Refer to the last two letters of your model number. You can locate your model number on the left-hand tub wall just inside the door. If your model number ends with BB, WW or CC, then you have a Painted Door panel. If your model number ends with SS, then you have a Stainless Steel Door panel. If your model number ends with CS, then you have a CleanSteel Door panel.

Follow the instructions below for cleaning the door panel for your specific model.

Painted Door Panel (model numbers ending in BB–black, WW–white or CC–bisque)

Use a clean, soft, lightly dampened cloth, then dry thoroughly. You may also use a good appliance wax or polish.

Stainless Steel Door Panel (model numbers ending in SS)

The stainless steel panels can be cleaned with *Stainless Steel Magic* or a similar product using a clean, soft cloth. Do not use appliance wax, polish, bleach or products containing chlorine on Stainless Steel doors.

You can order *Stainless Steel Magic* #WX10X15 through GE Parts by calling 800.626.2002.

CleanSteel Door Panel (model numbers ending in CS)

Use a clean, soft, lightly dampened cloth, then dry thoroughly. Do not use appliance wax, polish or any chemical agent on CleanSteel doors.

Do not wipe the dishwasher with a soiled dish cloth or wet towel. These may leave a residue. Do not use scouring pads or powdered cleaners because these products can scratch the finish.

Cleaning the Control Panel

To clean the control panel, use a lightly dampened cloth. Then dry thoroughly.

Stainless Steel Interior—Tub and Inner Door

The stainless steel used to make the dishwasher tub and inner door provides the highest reliability available in a GE dishwasher. If the dishwasher tub or inner door should be scratched or dented during normal use, they will not rust or corrode. These surface blemishes will not affect their function or durability.

Caring for the dishwasher.

Spray Arms and Filters

The dishwasher will flush away all normal food soils. However, objects (fruit pits, bones, etc.) may collect in openings and should be removed occasionally to avoid clogging the drain system.

▲ CAUTION: *Personal injury hazard. Before cleaning the interior, wait at least 20 minutes after a cycle for the heating element to cool down. Failure to do so could result in burn injuries.*

Cleaning the Spray Arms

Because hard water chemicals will clog the spray arm jets and bearings, it is necessary to clean the spray arms regularly. To remove the spray arm, twist the retaining nut 90 degrees and pull the spray arm off the shaft.

Wash the arms in soapy, warm water and use a soft brush to clean the jets. Replace them after rinsing thoroughly.

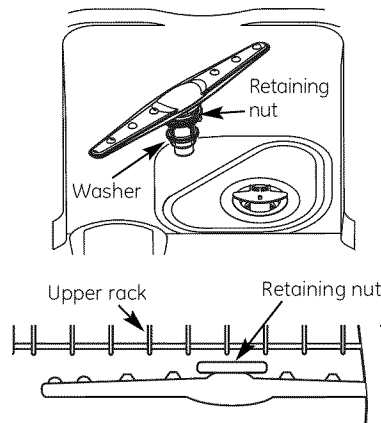

Cleaning the Filters

For best performance and results, the filter assembly must be cleaned regularly. The filter efficiently removes food particles from the wash water, allowing water to be recirculated during the cycle. For this reason, it is a good idea to remove the large food particles trapped in the filter frequently by rinsing the main filter and cup under running water. To remove the filter assembly, pull up on the cup handle. The entire filter assembly should be cleaned at least once a month. To clean the main filter and fine filter, use a cleaning brush. Then, reassemble the filter parts as shown in the illustration and reinsert the entire assembly in the dishwasher, positioning it in place and pressing downward. The dishwasher must never be used without the filters. Improper replacement of the filter may reduce the performance level of the appliance and may damage dishes and utensils.

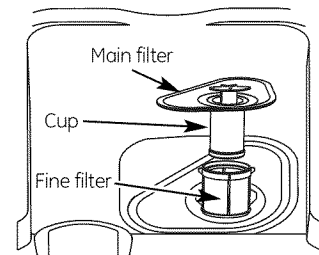

Protect Against Freezing

If your dishwasher is left in an unheated place during the winter, ask a service technician to:

- 1 Cut off electrical power to the dishwasher. Remove fuses or trip circuit breaker.
- 2 Turn off the water supply and disconnect the water inlet line from the water valve.

- 3 Drain water from the water inlet line and water valve. (Use a pan to catch the water.)
- 4 Reconnect the water inlet line to the water valve.

Does Your Dishwasher Have an Air Gap?

An air gap protects your dishwasher against water backing up into it if a drain clogs. The air gap is not a part of the dishwasher. It is not covered by your warranty. Not all plumbing codes require air gaps, so you may not have one.

The air gap is easy to clean.

- 1 Turn off the dishwasher and lift off the cover.
- 2 Remove the plastic cap and clean with a toothpick.

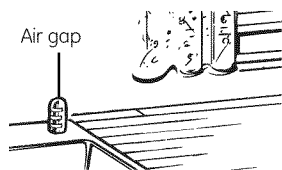

Check the air gap any time your dishwasher isn't draining well.

Before you call for service...

ge.com



Troubleshooting Tips
Save time and money! Review the charts on the following pages, or visit ge.com. You may not need to call for service.

Problem	Possible Causes	What To Do
Dishes and flatware not clean	Low inlet water temperature	<ul style="list-style-type: none"> Make sure inlet water temperature is correct (see page 6). Turn on the hot water faucet nearest the dishwasher, let run until the water temperature stops rising. Then start the dishwasher and turn off the faucet. This insures the entering water is hot.
	Water pressure is temporarily low	<ul style="list-style-type: none"> Turn on a faucet. Is water coming out more slowly than usual? If so, wait until pressure is normal before using your dishwasher.
	Air gap or disposer is clogged	<ul style="list-style-type: none"> Clean the air gap or flush the disposer.
	Improper rack loading	<ul style="list-style-type: none"> Make sure large dishware does not block the detergent dispenser or the wash arms. See the <i>Loading the dishwasher racks</i> section.
	No air gap or high drain loop	<ul style="list-style-type: none"> Verify that you have an air gap or a high drain loop. Refer to the Installation Instructions.
Spots and filming on glasses and flatware	Extremely hard water	<ul style="list-style-type: none"> Use <i>Jet-Dry</i>® or <i>Cascade Crystal Clear</i>® rinse agents to remove spots and prevent new film buildup.
	Low inlet water temperature Overloading the dishwasher Improper loading Old or damp powder detergent Rinse agent dispenser empty Too little detergent	<ul style="list-style-type: none"> To remove stubborn spots and pre-existing film from glassware: <ol style="list-style-type: none"> Remove all metal utensils from the dishwasher. Do not add detergent. Select the <i>POTS & PANS</i> cycle. Start the dishwasher and allow to run for 18 to 22 minutes. Dishwasher will now be in the main wash. Open the door and pour 2 cups (500 ml) of white vinegar into the bottom of the dishwasher. Close the door and allow to complete the cycle. If vinegar rinse doesn't work: Repeat as above, except use 1/4 cup (60 ml) of citric acid crystals instead of vinegar.
Cloudiness on glassware	Combination of soft water and too much detergent	<ul style="list-style-type: none"> This is called <i>etching</i> and is permanent. To prevent this from happening, use less detergent if you have soft water. Wash glassware in the shortest cycle that will get them clean.
	Water temperature entering the dishwasher exceeds 150°F	<ul style="list-style-type: none"> This could be etching. Lower the water heater temperature.
Suds in the tub	Correct detergent wasn't used	<ul style="list-style-type: none"> Use only automatic dishwasher detergents to avoid sudsing. <i>Cascade</i>® and <i>Electrasol</i>® Automatic Dishwashing Detergents have been approved for use in all GE dishwashers. To remove suds from the tub, open the dishwasher and let suds dissipate. Close and latch the dishwasher. Pump out water by touching the START/RESET pad once; then 30 seconds later, touch the START/RESET pad again. Repeat if necessary.
	Rinse agent was spilled	<ul style="list-style-type: none"> Always wipe up rinse agent spills immediately.

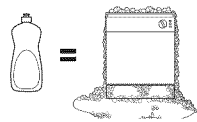

Safety Instructions

Operating Instructions

Troubleshooting Tips

Consumer Support

Before you call for service...

Problem	Possible Causes	What To Do
Detergent left in dispenser cups	Dishes are blocking the detergent cup	<ul style="list-style-type: none"> • Reposition the dishes, so the water from the lower spray arm can flush the detergent cup. See the <i>Loading the dishwasher</i> section.
Black or gray marks on dishes	Aluminum utensils have rubbed against dishes	<ul style="list-style-type: none"> • Remove marks with a mild, abrasive cleaner.
Dishes don't dry	Low inlet water temperature	<ul style="list-style-type: none"> • Make sure inlet water temperature is at least 120°F. • Select HEATED DRY. • Use HOT START, HOT WASH or ADDED HEAT options. • Select a higher cycle, such as POTS & PANS.
	Rinse agent dispenser is empty	<ul style="list-style-type: none"> • Check the rinse agent dispenser and fill as required.
Control panel responded to inputs but dishwasher never filled with water	Door latch may not be properly seated	<ul style="list-style-type: none"> • Make sure the door is firmly closed.
	Water valve may be turned off	<ul style="list-style-type: none"> • Make sure water valve (usually located under the sink) is turned on.
Stained tub interior	Some tomato-based foods can cause reddish stains	<ul style="list-style-type: none"> • Use of the RINSE ONLY cycle after adding the dish to the load can decrease the level of staining. GE recommends Cascade® Plastic Booster to help remove these types of stains.
	Tea or coffee stains	<ul style="list-style-type: none"> • Remove the stain by hand, using a solution of 1/2 cup bleach and 3 cups warm water. <p>▲ WARNING Before cleaning interior, wait at least 20 minutes after a cycle for the heating elements to cool down. Failure to do so can result in burns.</p>
	An overall yellow or brown film can be caused by iron deposits in water	<ul style="list-style-type: none"> • A special filter in the water supply line is the only way to correct this problem. Contact a water softener company.
	White film on inside surface—hard water minerals	<ul style="list-style-type: none"> • GE recommends Jet-Dry® or Cascade Crystal Clear® to help prevent hard water mineral deposits from forming. • Run dishwasher with citric acid to remove mineral deposits. Citric acid (Part number: WD35X151) can be ordered through GE Parts. See back cover for ordering information.
Dishwasher won't run	Fuse is blown or circuit breaker is tripped	<ul style="list-style-type: none"> • Replace fuse or reset circuit breaker. Remove any other appliances from the circuit.
	Power is turned off	<ul style="list-style-type: none"> • In some installations, the power to the dishwasher is provided through a wall switch, often located next to the disposer switch. Make sure it is on.
	Control panel is locked	<ul style="list-style-type: none"> • Unlock control panel. See page 4.
	Reboot your control	<ul style="list-style-type: none"> • Turn off power to the dishwasher (circuit breaker or wall switch) for 30 seconds; then turn back on.
Control panel lights go off when you're setting controls	Time too long between touching of selected pads	<ul style="list-style-type: none"> • Each pad must be touched within 30 seconds of the others. To relight, touch any pad again, or unlock and relatch door.
Water standing in the bottom of the tub	This is normal	<ul style="list-style-type: none"> • A small amount of clean water around the outlet on the tub bottom at the back of the tub keeps the water seal lubricated.
Water won't pump out of the tub	Drain is clogged	<ul style="list-style-type: none"> • If you have an air gap, clean it. See page 10. • If the dishwasher drains into a disposer, run disposer clear. • Check to see if your kitchen sink is draining well. If not, you may need a plumber.
Steam	This is normal	<ul style="list-style-type: none"> • Warm, moist air comes through the vent by the door latch during drying and when water is being pumped out. This is necessary for drying.
Sanitized light does not illuminate at the end of the cycle (Anti-Bacteria cycle only)	The door was opened and the cycle was interrupted during or after the main wash portion	<ul style="list-style-type: none"> • Do not interrupt the cycle anytime during or after main wash.
	The incoming water temperature was too low	<ul style="list-style-type: none"> • Raise the water heater temperature to between 120°F and 140°F.
Noise	Normal operating sounds	<ul style="list-style-type: none"> • Detergent cup opening. • Water entering dishwasher. • The motor stops and starts at various times during the cycle. • Drain pump sounds during the pump out.
	Rattling dishes when the spray arm rotates	<ul style="list-style-type: none"> • Make sure dishes are properly loaded. See the <i>Loading the dishwasher racks</i> section.

Notes.

<i>Safety Instructions</i>	<i>Operating Instructions</i>	<i>Troubleshooting Tips</i>	<i>Consumer Support</i>
----------------------------	-------------------------------	-----------------------------	-------------------------

Notes.

Safety Instructions

Operating Instructions

Troubleshooting Tips

Consumer Support

GE Dishwasher Warranty.



All warranty service provided by our Factory Service Centers, or an authorized Customer Care[®] technician. To schedule service, on-line, 24 hours a day, visit us at ge.com, or call 800.GE.CARES (800.432.2737). Please have serial number and model number available when calling for service.

Staple your receipt here.
Proof of the original purchase date is needed to obtain service under the warranty.

For The Period Of: GE Will Replace:

One Year

From the date of the original purchase

Any part of the dishwasher which fails due to a defect in materials or workmanship. During this **limited one-year warranty**, GE will also provide, **free of charge**, all labor and related service to replace the defective part.

What GE Will Not Cover:

- Service trips to your home to teach you how to use the product.
- Improper installation, delivery or maintenance.
- Failure of the product if it is abused, misused, or used for other than the intended purpose or used commercially.
- Replacement of house fuses or resetting of circuit breakers.
- Damage to the product caused by accident, fire, floods or acts of God.
- Incidental or consequential damage caused by possible defects with this appliance.
- Cleaning or servicing of the air gap device in the drain line.
- Damage caused after delivery.
- Product not accessible to provide required service.

EXCLUSION OF IMPLIED WARRANTIES—Your sole and exclusive remedy is product repair as provided in this Limited Warranty. Any implied warranties, including the implied warranties of merchantability or fitness for a particular purpose, are limited to one year or the shortest period allowed by law.

This warranty is extended to the original purchaser and any succeeding owner for products purchased for home use within the USA. If the product is located in an area where service by a GE Authorized Servicer is not available, you may be responsible for a trip charge or you may be required to bring the product to an Authorized GE Service location for service. Proof of original purchase date is needed to obtain service under the warranty. In Alaska, the warranty excludes the cost of shipping or service calls to your home.

Some states do not allow the exclusion or limitation of incidental or consequential damages. This warranty gives you specific legal rights, and you may also have other rights which vary from state to state. To know what your legal rights are, consult your local or state consumer affairs office or your state's Attorney General.

Warrantor: General Electric Company. Louisville, KY 40225

Consumer Support.



GE Appliances Website

ge.com

Have a question or need assistance with your appliance? Try the GE Appliances Website 24 hours a day, any day of the year! For greater convenience and faster service, you can now download Owner's Manuals, order parts or even schedule service on-line.

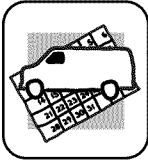

Schedule Service

ge.com

Expert GE repair service is only one step away from your door. Get on-line and schedule your service at your convenience 24 hours any day of the year! Or call 800.GE.CARES (800.432.2737) during normal business hours.

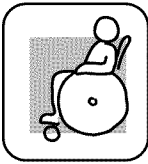

Real Life Design Studio

ge.com

GE supports the Universal Design concept—products, services and environments that can be used by people of all ages, sizes and capabilities. We recognize the need to design for a wide range of physical and mental abilities and impairments. For details of GE's Universal Design applications, including kitchen design ideas for people with disabilities, check out our Website today. For the hearing impaired, please call 800.TDD.GEAC (800.833.4322).



Extended Warranties

ge.com

Purchase a GE extended warranty and learn about special discounts that are available while your warranty is still in effect. You can purchase it on-line anytime, or call 800.626.2224 during normal business hours. GE Consumer Home Services will still be there after your warranty expires.

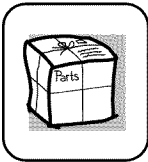

Parts and Accessories

ge.com

Individuals qualified to service their own appliances can have parts or accessories sent directly to their homes (VISA, MasterCard and Discover cards are accepted). Order on-line today, 24 hours every day or by phone at 800.626.2002 during normal business hours.

Instructions contained in this manual cover procedures to be performed by any user. Other servicing generally should be referred to qualified service personnel. Caution must be exercised, since improper servicing may cause unsafe operation.



Contact Us

ge.com

If you are not satisfied with the service you receive from GE, contact us on our Website with all the details including your phone number, or write to:

General Manager, Customer Relations
GE Appliances, Appliance Park
Louisville, KY 40225



Register Your Appliance

ge.com

Register your new appliance on-line—at your convenience! Timely product registration will allow for enhanced communication and prompt service under the terms of your warranty, should the need arise. You may also mail in the pre-printed registration card included in the packing material, or detach and use the form in this Owner's Manual.

