

This Owner's Manual is provided and hosted by [Appliance Factory Parts](#).



Broil King 955-98 Owner's Manual

[Shop genuine replacement parts for Broil King 955-98](#)



[Find Your Broil King Grill Parts - Select From 1350 Models](#)

----- Manual continues below part list -----

Available Replacement Parts for Broil King 955-98

03200	spark generator; Bmstr, DCS, Ducane
14625	warming rack universal, 15 x 6.5
10696-160	ORIFICE HOOD R/B 0.160MM NG
119-5000-0	GGK IGNITOR
10472-K36	KNOB GAS VALVE 1 3/4 #E +
11219	CI COOKING GRID - 50M BTU
18434	INFINITY BURNER T501
10156-K55	HEAT SHIELD 950 2600
18488	FLAV-R-WAVE - 50,000 BTU STAINLESS
10225-T422	GRID PORCELAIN WIRE T42/T45 .6
10342-T301	IGNITOR ELECTRODE ASSEMBLY 8 BURNER 1993
18013	LARGE PROBE HEAT INDICATOR
10184-K581	SHELF SUPPORT LFT BLK
10184-K591	SHELF SUPPORT RH BLK
S15111	GREASE CUP HOLDER ALL P8069A +
10342-22	IGNITOR W/PALNUT DUAL
10086-K521	DECO PANEL 950 90 4V 24 7/8
10225-T10	GRID PORCELAIN S/B
10393-K40	SIDE BURNER COVER 1.86
10086-K511	DECO PANEL 950 40 3V 24 7/8
10081-BK630	NAMEPLATE HI BROIL KING BLACK ZINC
10240-15	HINGE PIN SIDE SHELF DROP DOWN
S21237	HINGE PIN SPACER
10110-91	TUBE R/B ASSY COMPR FITTING
S21124	SCREW PHCP #8 X 12 +
PB20-60A	S/B LID HANDLE WAGON ENCLOSER+ W/SCREWS
10390-E10	BURNER SIDE 10BTU W/ELEC #8 +
10393-R50	SIDE BURNER BODY 2002 +
10958-K531	POST BLACK
10239-7	HANDLE GASKET TRIANGULAR 1/8

Y-12220	S/B BUSHING SB 1.375 16 HEY
10342-T12	WIRE ELECTRODE S/B FLAT/FLAT
02342	control knob; universal
10111-K23	HOSE 23 INCH PIGTAIL FITTING POST
30260130	SHELF SIDE REV A +
10472-k40	KNOB ROTARY IGNITOR #B
10225-T423	GRID PORCELAIN WIRE T42/T45 .4
10958-K541	POST COVER BLACK
Y-11990	NUT HEX BRASS 3/8 27 RB LINE

Broil King®

REDDI-BILT BARBECUES

ASSEMBLY MANUAL & PARTS LIST

MANUAL DE MONTAGE & LISTE DE PIÈCES



955-18
955-28



955-78

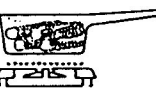

955-98



RETAIN FOR FUTURE REFERENCE

VEUILLEZ CONSERVER POUR REFERENCE ULTERIEURE

Onward
MANUFACTURING COMPANY
SINCE 1906
585 KUMPF DRIVE LIMITED
WATERLOO, ONTARIO, CANADA
N2V 1K3

1

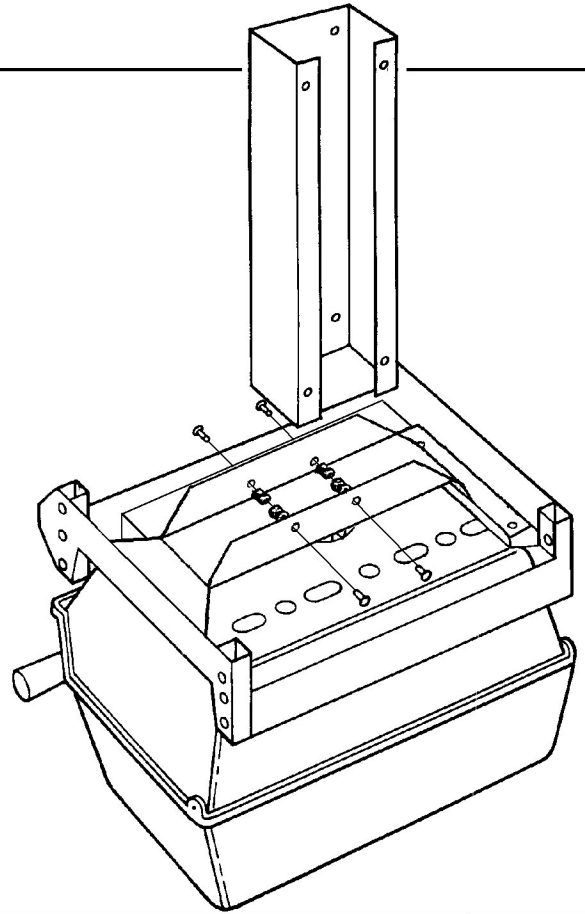
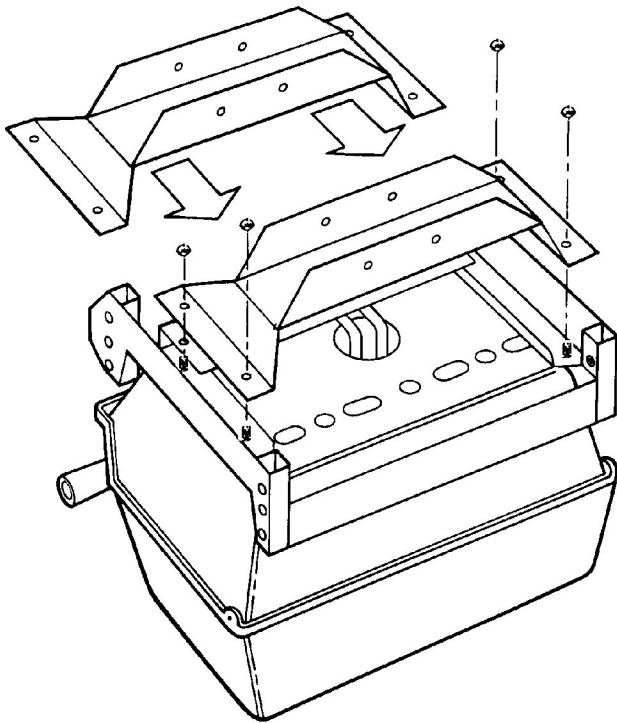
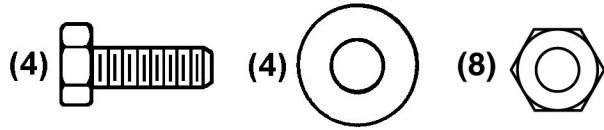

2

11240 IN GROUND POST
(OPTIONAL)

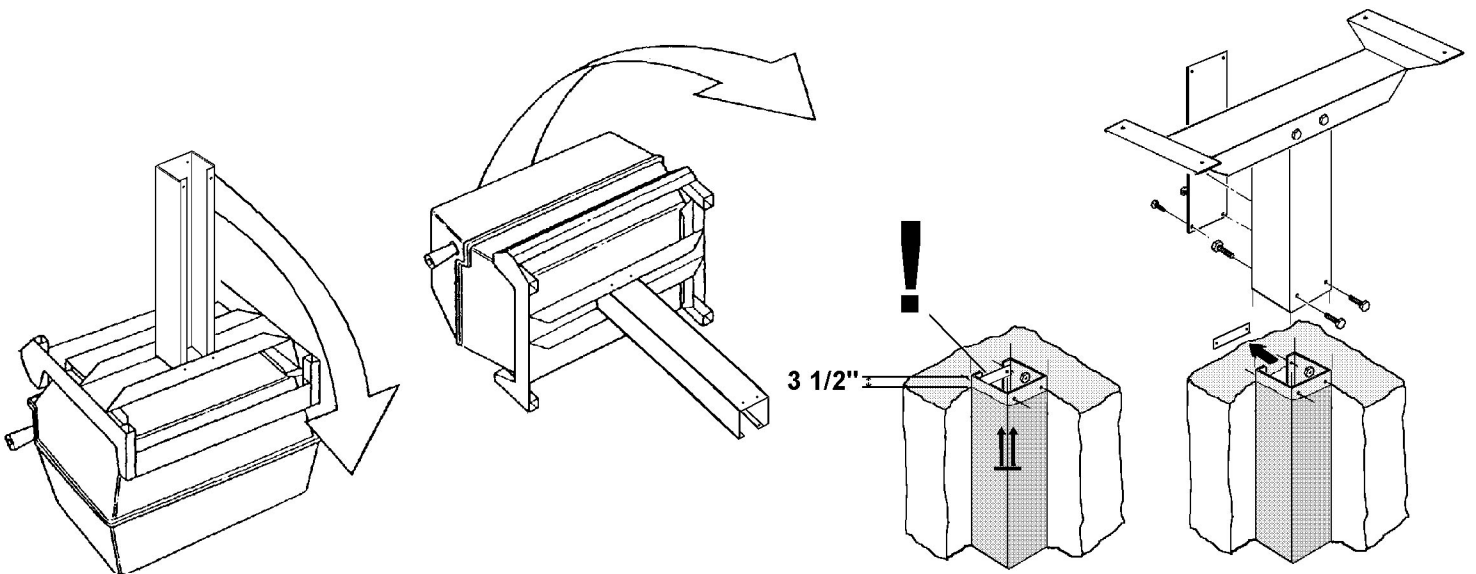
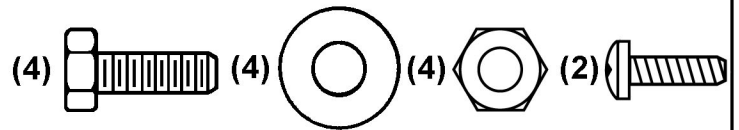

2

11300 DECK MOUNT
(OPTIONAL)

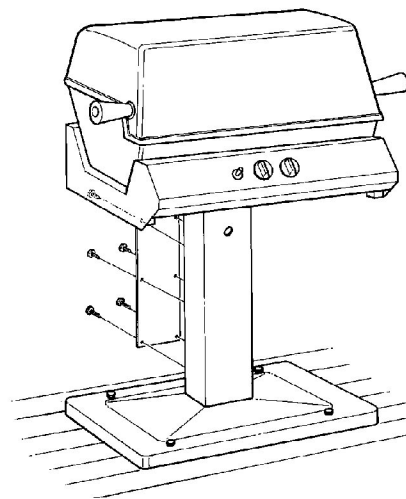
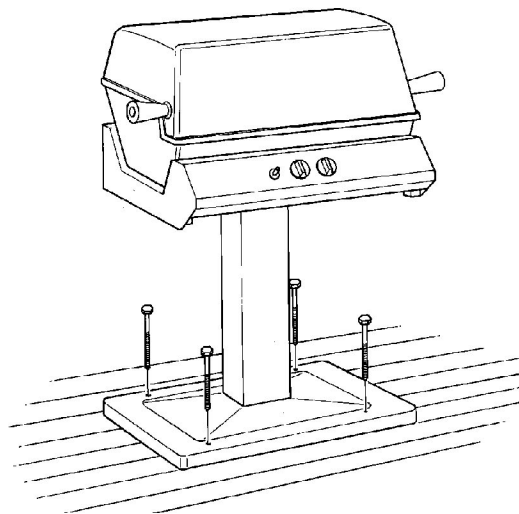
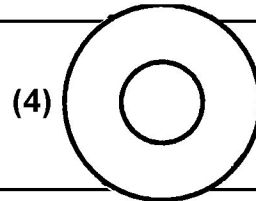
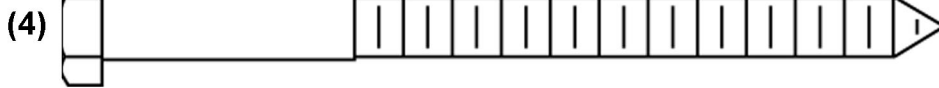
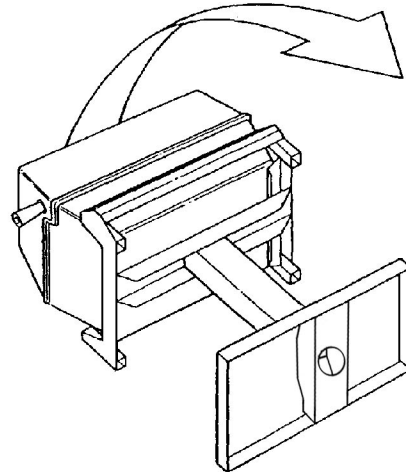
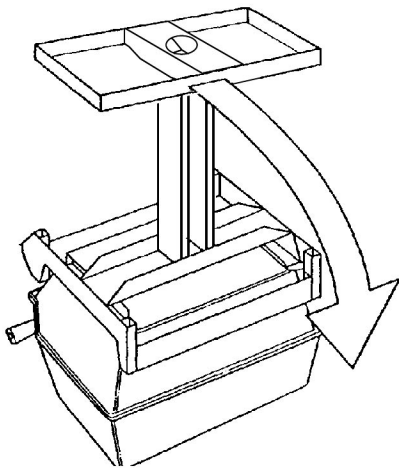
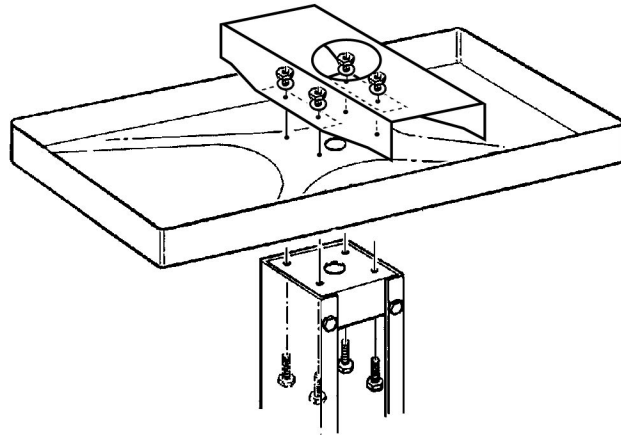
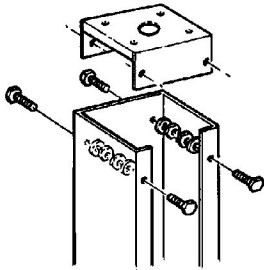
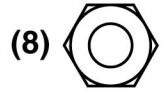
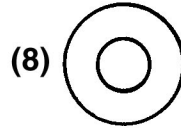

3

(1)



(1)

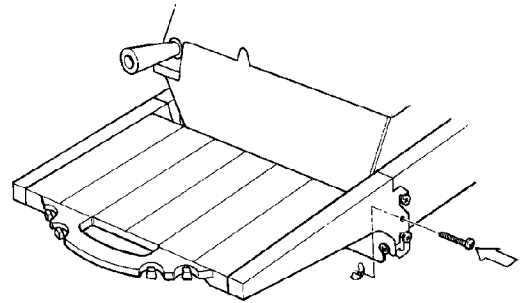
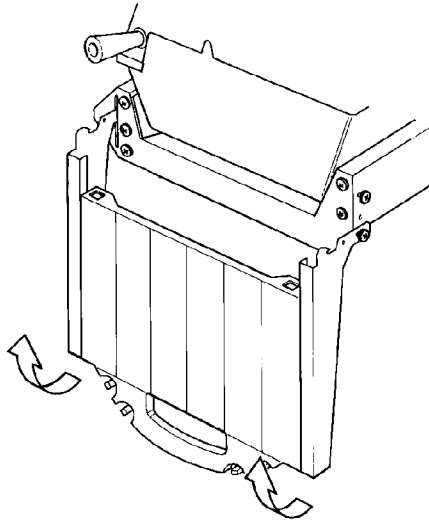
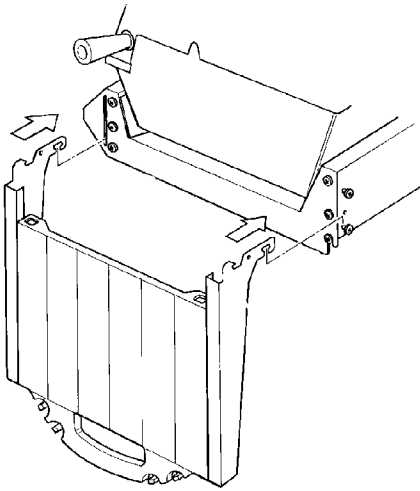
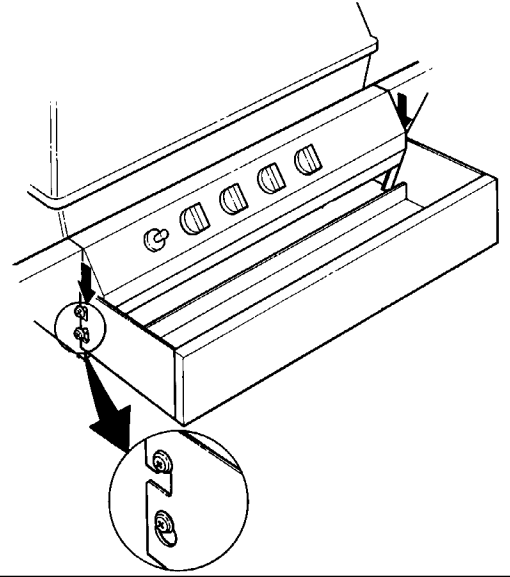
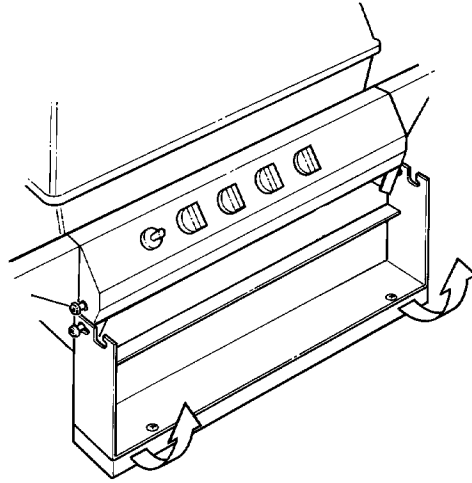
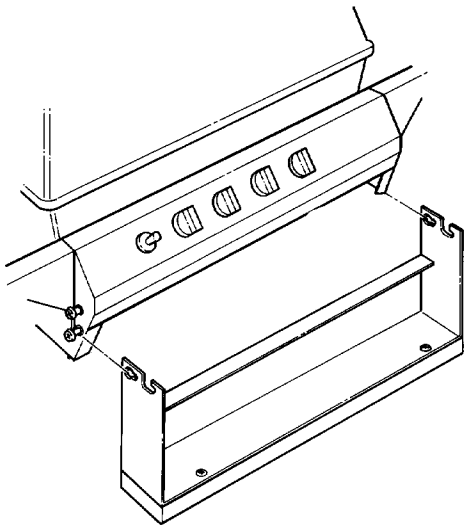
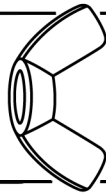



(1)

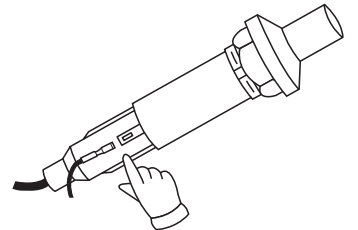
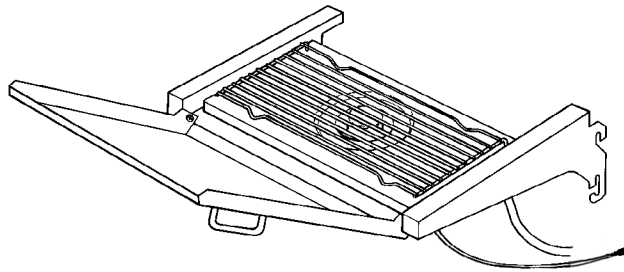
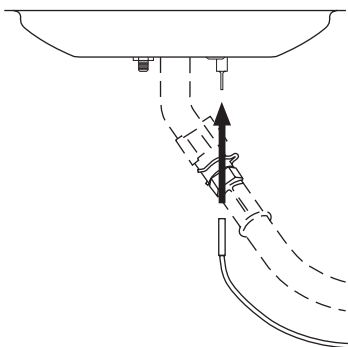
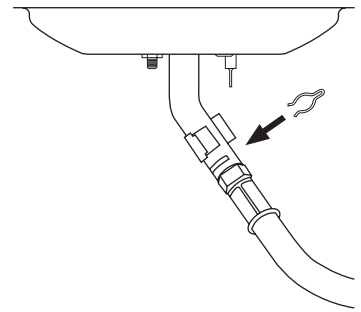
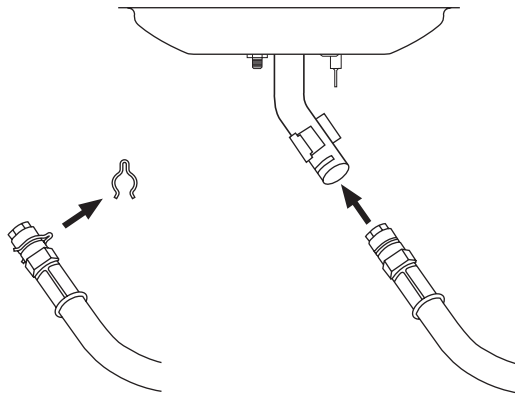
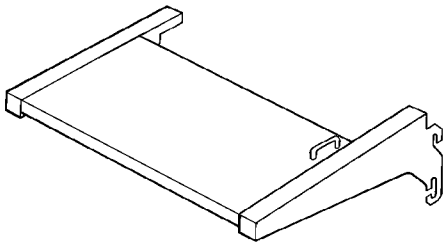
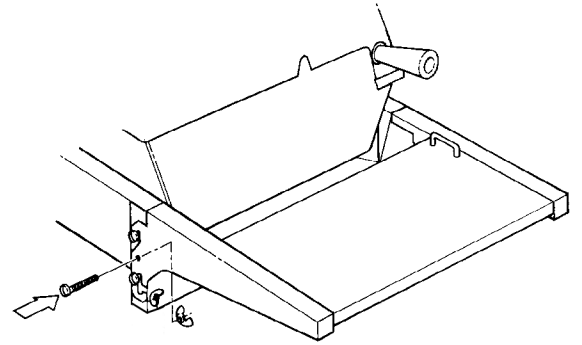
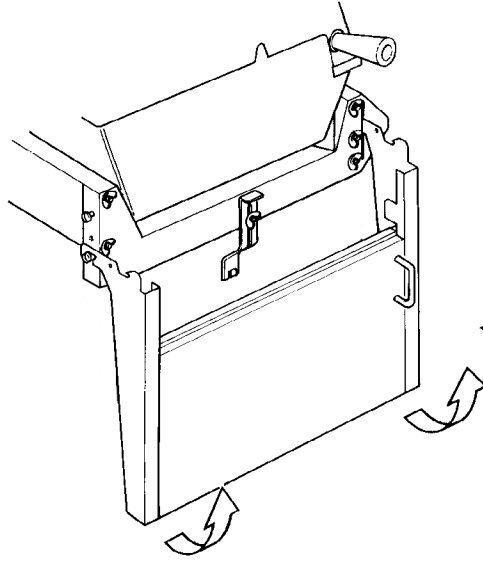
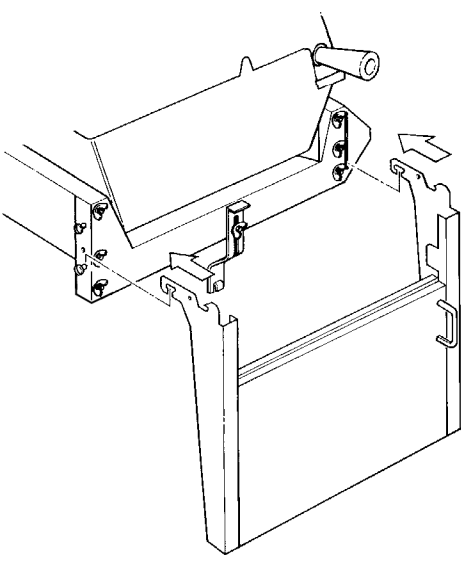
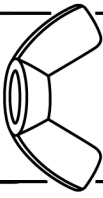

4

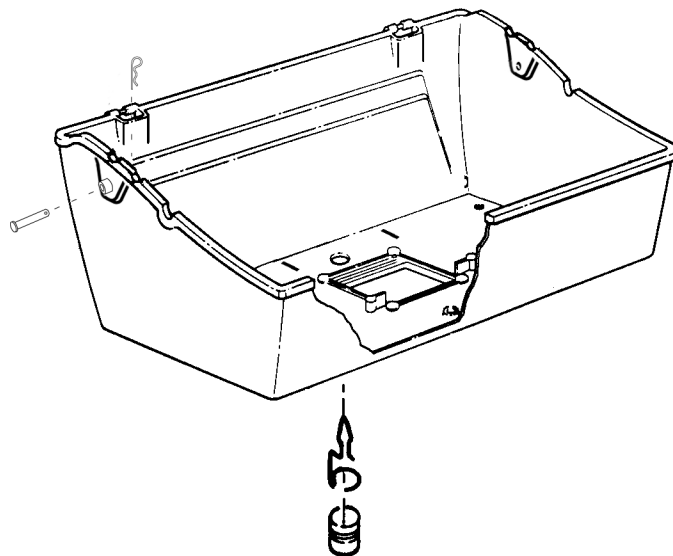
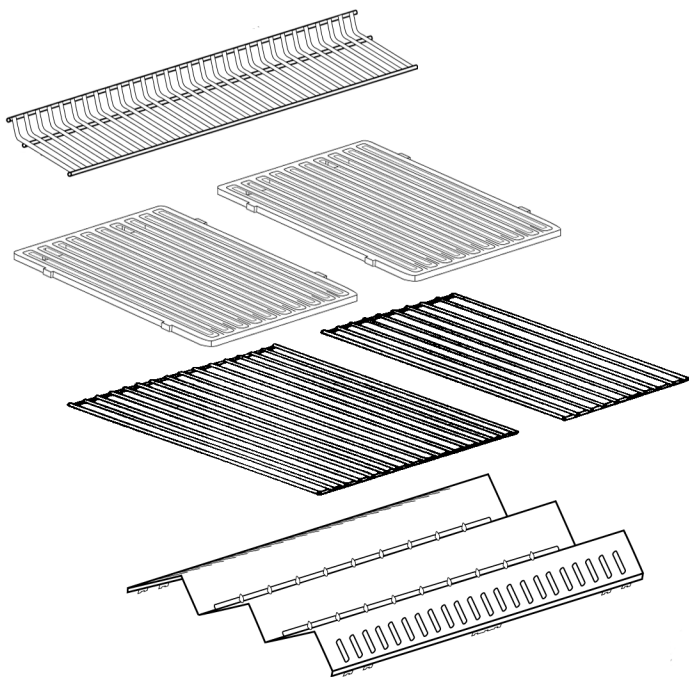
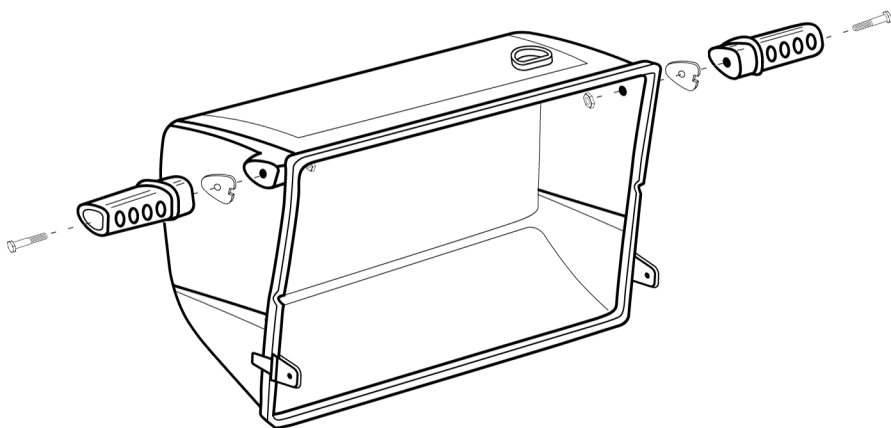
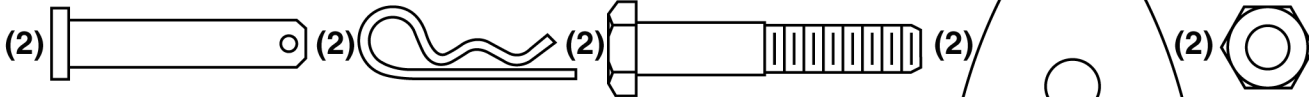

KEY	ITEM #	955-18	955-28	955-78	955-98
1	10909-T45	1	1	1	1
2	10473-T45	1	1	1	1
3	10081-BK603	1	1	1	1
4	10958-K70	1	1	1	1
5	10571-6	1	1	1	1
6	10240-15	2	2	2	2
6A.	S21237	2	2	2	2
7	S21233	2	2	2	2
8	10222-T425	1	1	1	1
9	10225-T422	1	•	•	•
	10225-T423	1	•	•	•
	10225-T429	•	2	2	2
11	10225-T451	1	1	1	1
15	10390-T501	1	1	1	1
17	10342-21	1	1	1	•
	10342-22	•	•	•	1
18	10342-T301	1	1	1	1
21	10440-K51	1	1	•	•
	10440-R63	•	•	1	•
	10442-R57	•	•	•	1
21A.	S13467-132	•	•	•	1
	Y-11230	•	•	•	1
21B.	10110-91	•	•	1	1
22	10111-K23	1	1	1	1
23	10472-K36	2	2	3	4
30	10086-K501	1	1	•	•
	10086-K531	•	•	1	•
	10086-K521	•	•	•	1
31	10194-K501	1	1	1	1
35	10184-K561	1	1	1	1
36	10184-K571	1	1	1	1
37	10184-K581	2	2	2	2
38	10184-K591	2	2	2	2
39	10958-K641	1	1	1	1
40	10958-K571	1	1	1	1
41	10958-K631	1	1	1	1
42	10958-K521	1	1	1	1
46	10958-K531	1	1	1	1
47	10958-K541	1	1	1	1
49	10711-K541	1	1	1	1
50	10711-K551	2	2	2	1
53	S16144-2	1	1	1	1
57	10156-K55	1	1	1	1
65	S13009	•	•	1	1
68	S21362	•	•	2	2
70	Y-11990	•	•	1	1
71	10696-160	•	•	1	1
74	Y-6616	2	2	2	2
75	10338-145	2	2	2	2
76	10239-6	2	2	2	2
77	S15111	1	1	1	1
80	Y-11560	12	12	12	12
82	Y-12860	16	16	16	16
83	S21014	8	8	8	8
84	Y-12220	1	1	1	1

KEY	ITEM #	955-18	955-28	955-78	955-98
85	Y-11211	16	16	16	16
87	Y-11793	24	24	24	24
88	Y-11598	8	8	8	8
96	Y-29305	2	2	2	2
98	S21124	26	26	26	26
99	Y-12646	4	4	4	6
101	Y-12853	•	4	4	4
104	Y-12835	2	2	2	2
105	Y-29307	•	•	•	4
108	PB20-60	•	•	•	1
109	S21136	•	•	•	1
110	10225-T10	•	•	•	1
111	10390-E10	•	•	•	1
113	10342-T12	•	•	•	1
114	10393-K40	•	•	•	1
115	Y-29305	2	2	2	12
117	10393-R50	•	•	•	1

OPTIONAL

PATIO BASE ASSEMBLY 11300

40	10958-K571	1
45	10184-K80	1
48	10958-K561	1
83	S21014	4
85	Y-11211	4
87	Y-11793	4
90	Y-12286	4
92	Y-12851	4

POST EXTENSION ASSEMBLY 11240

43	10958-K55	1
83	S21014	2
86	10958-K58	1
87	Y-11793	2

