

This Owner's Manual is provided and hosted by [Appliance Factory Parts](#).



Broil King 961-94 Owner's Manual

[Shop genuine replacement parts for Broil King 961-94](#)



[Find Your Broil King Grill Parts - Select From 1350 Models](#)

----- Manual continues below part list -----

Available Replacement Parts for Broil King 961-94

18434	INFINITY BURNER T501
10892-8NG	WHEEL 8 INCH GREY WALL
10225-T627	GRID SWING BASKET IMPERIAL BLACK
10225-T528	GRID FLAT WARM RACK T50 PORC +
18488	FLAV-R-WAVE - 50,000 BTU STAINLESS
10342-T301	IGNITOR ELECTRODE ASSEMBLY 8 BURNER 1993
18013	LARGE PROBE HEAT INDICATOR
10184-R19	TANK RETAINER-PEDESTAL-NEW
10225-T10	GRID PORCELAIN S/B
10393-K40	SIDE BURNER COVER 1.86
10081-BK630	NAMEPLATE HI BROIL KING BLACK ZINC
10240-15	HINGE PIN SIDE SHELF DROP DOWN
S21237	HINGE PIN SPACER
10110-91	TUBE R/B ASSY COMPR FITTING
10892-15	CASTER 2 1/2 INCH WHEEL KNURLED
S15171	AXLE PLTD 3/8x18 9/16 PED +
S21124	SCREW PHCP #8 X 12 +
PB20-60A	S/B LID HANDLE WAGON ENCLOSER+ W/SCREWS
10390-E10	BURNER SIDE 10BTU W/ELEC #8 +
10342-T14	WIRE ELECTRODE S/B FLAT/ROUND+
10393-R50	SIDE BURNER BODY 2002 +
10239-7	HANDLE GASKET TRIANGULAR 1/8
50416	SMALL DRIP PAN - 10 PACK
02342	control knob; universal
10342-246	IGNITOR ELECTRONIC TRIPLE +
10184-R80	RADIATION SHIELD RAW
S13005A	BURNER TUBULAR W/IGNITION
10696-127	R/B ORIFICE LP
10696-185	R/B ORIFICE NG 1.85MM
10909-T50	CASTING BOTTOM 52M 2002 +

10473-T50	CASTING TOP 52M
10184-K651	SUPPORT CASTING LEFT
Y-11797	BOLT SWING BASKET #D
80012	regulator and hose READ ADD. INFO
10342-245	IGNITOR ELECTRONIC DUAL +
11151	SS COOKING GRID - SOVEREIGN
10958-E71	PEDESTAL RESIN BASE LRG +
10111-K45	HOSE 3/8 INCH ASSEMBLY NG 10 FOOT +
Y-11990	NUT HEX BRASS 3/8 27 RB LINE

Broil King®

REDDI-BILT BARBECUES

ASSEMBLY MANUAL & PARTS LIST

MANUEL DE MONTAGE & LISTE DE PIÈCES

Broil King®
SOVEREIGN 79
961-74
961-77



Broil King®
SOVEREIGN 99
961-94
961-97



RETAIN FOR FUTURE REFERENCE

VEUILLEZ CONSERVER POUR REFERENCE ULTERIEURE

Onward
MANUFACTURING COMPANY
SINCE 1906
585 KUMPF DRIVE LIMITED
WATERLOO, ONTARIO, CANADA
N2V 1K3

1

(2)

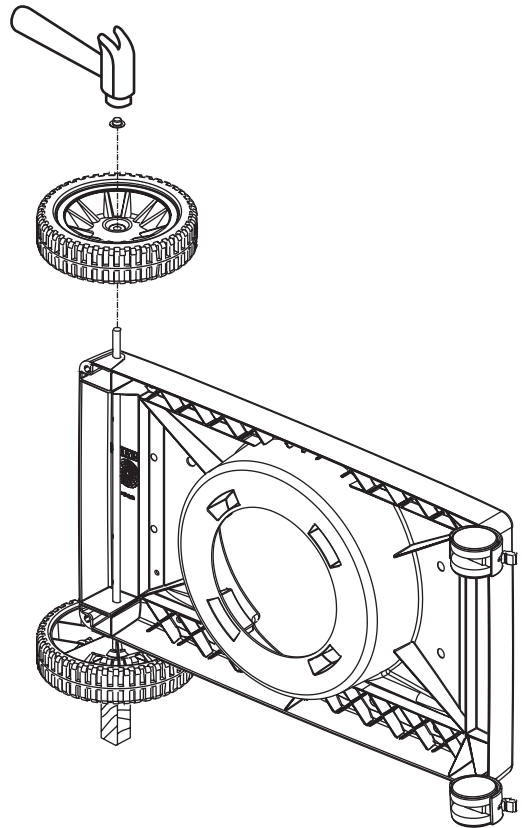
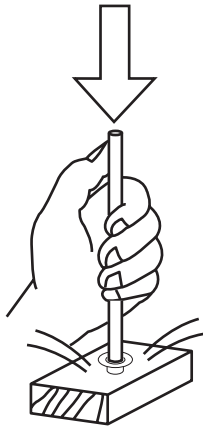
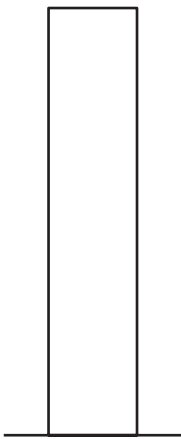
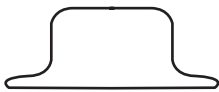
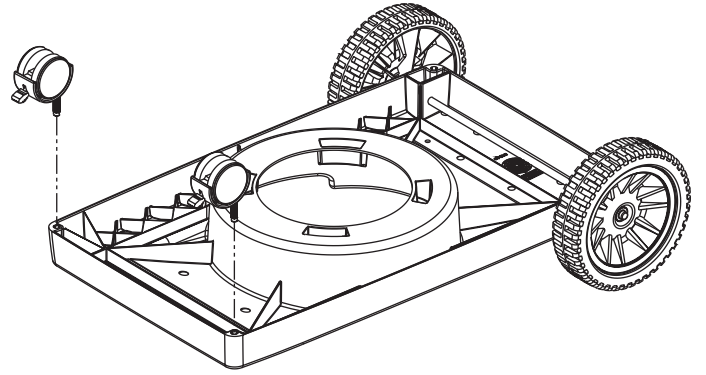
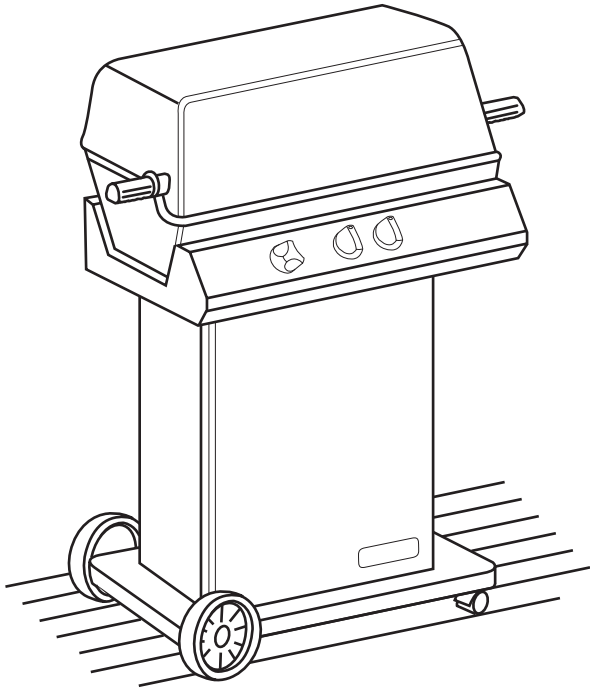

2

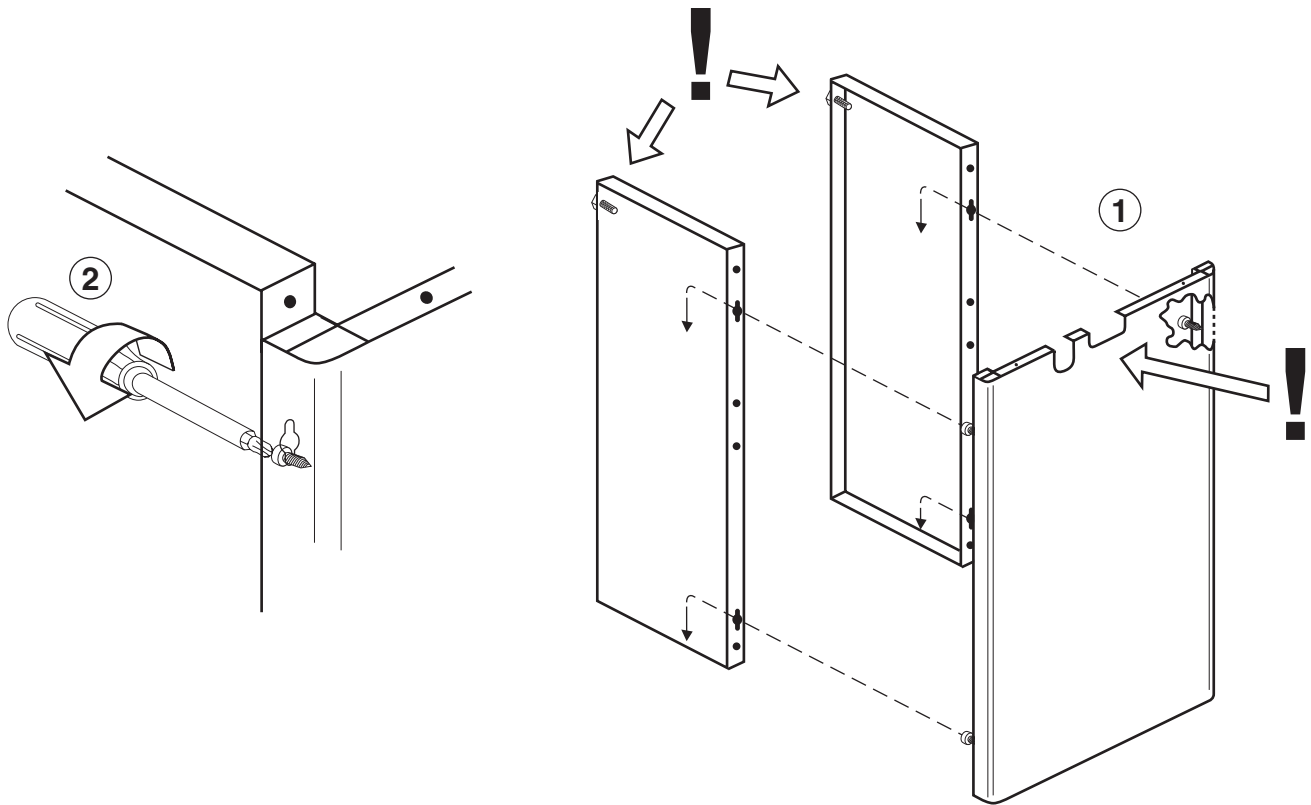

3

(6) 

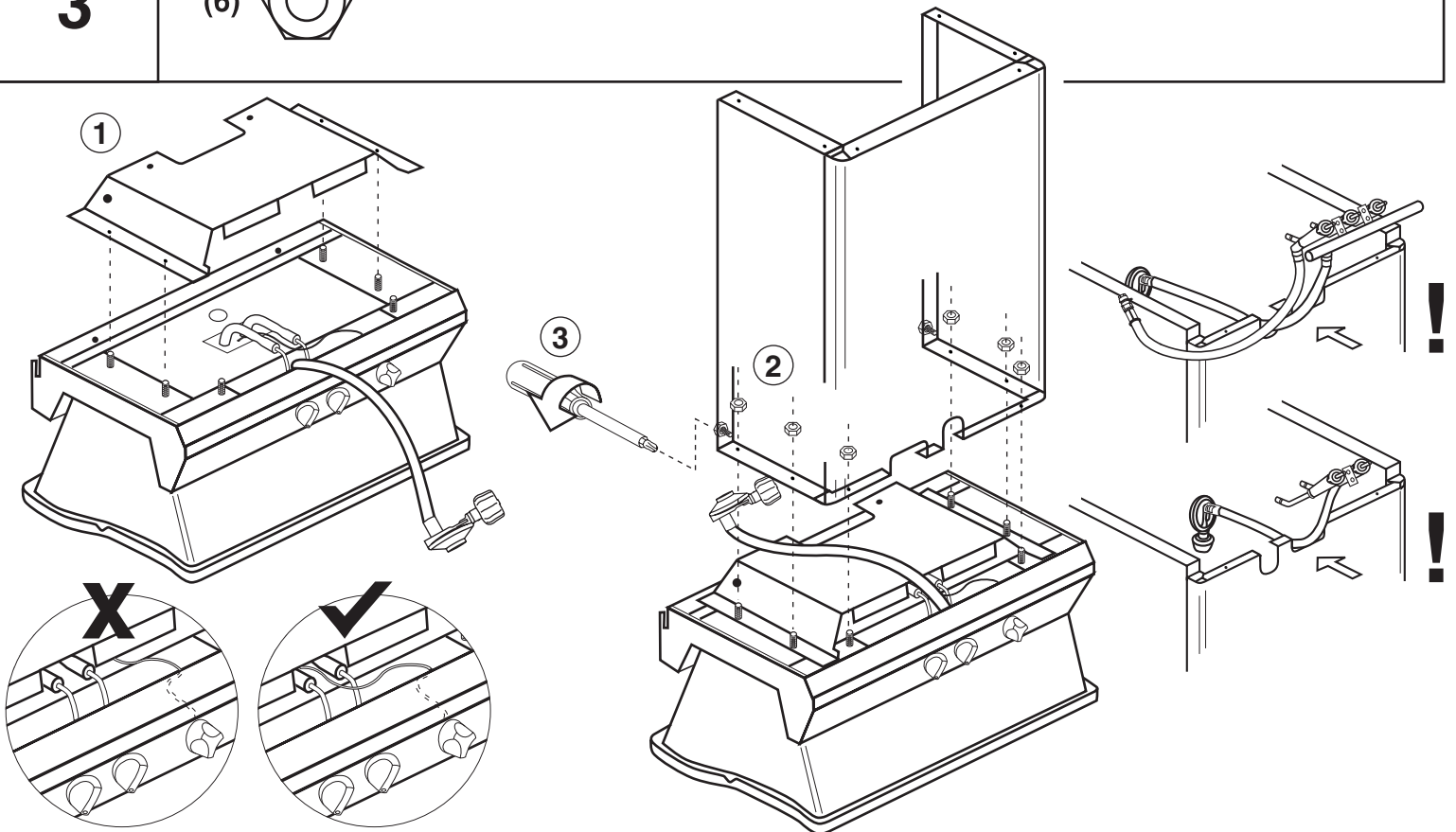

4

(8)

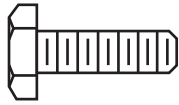

(8)

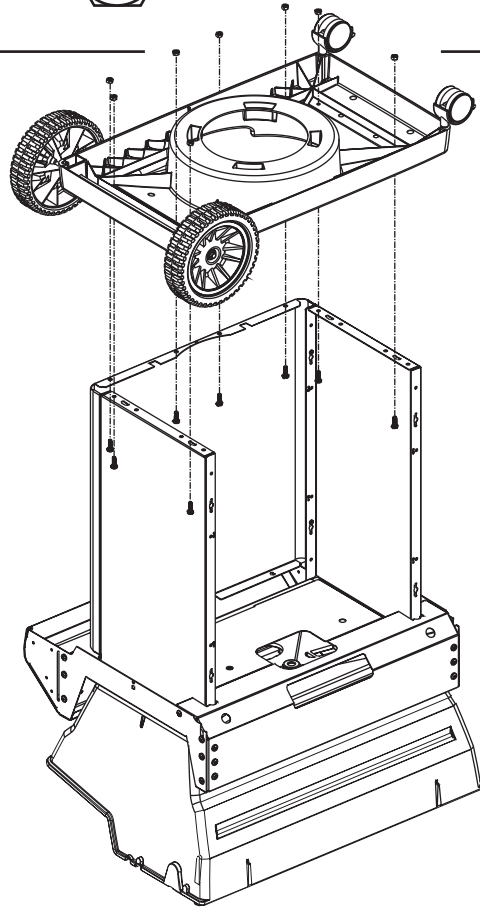

5

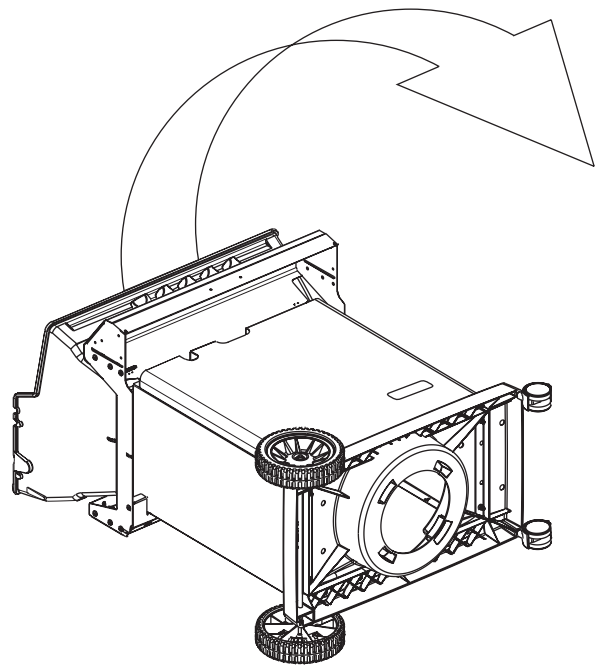
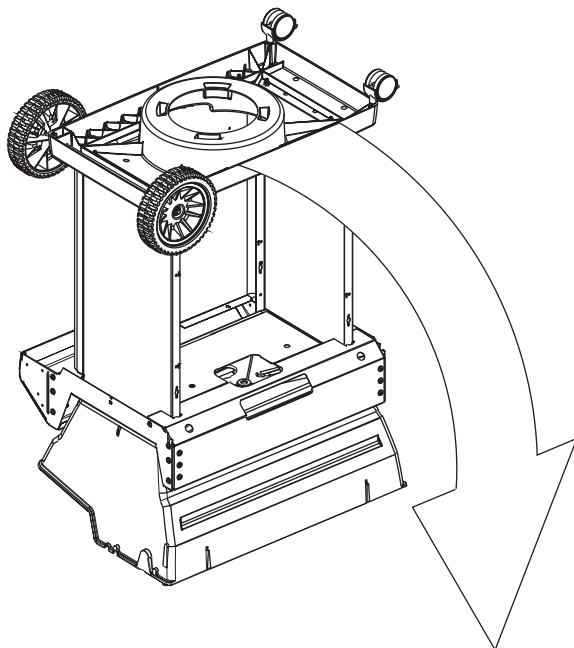

6

(2) 

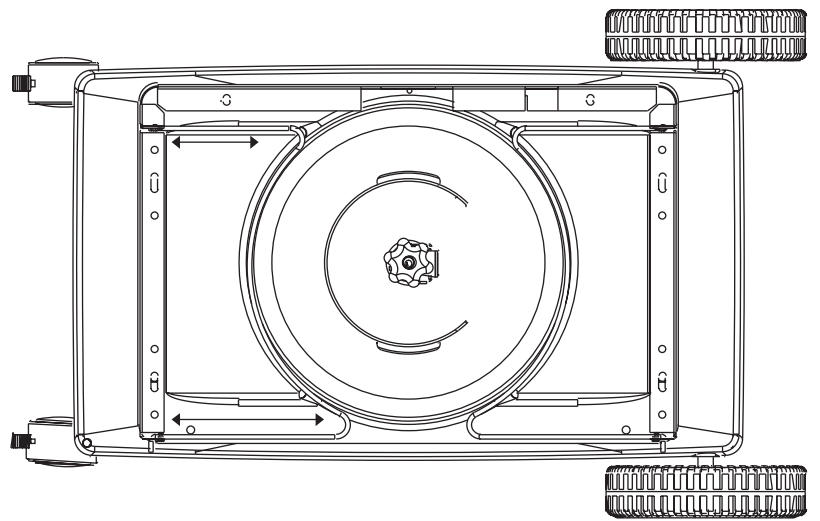
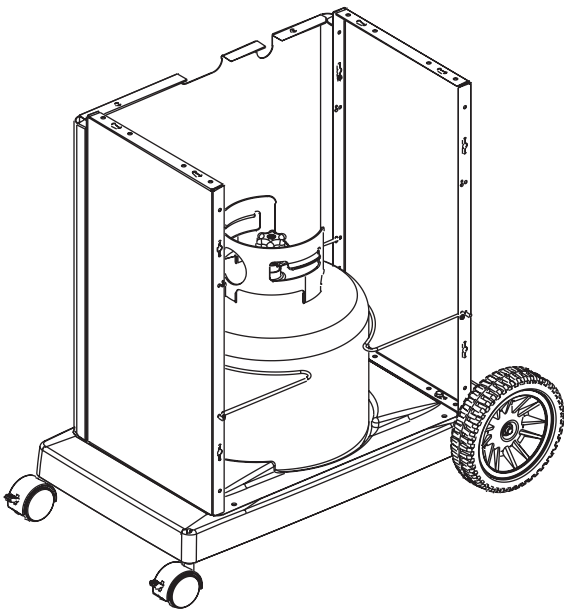
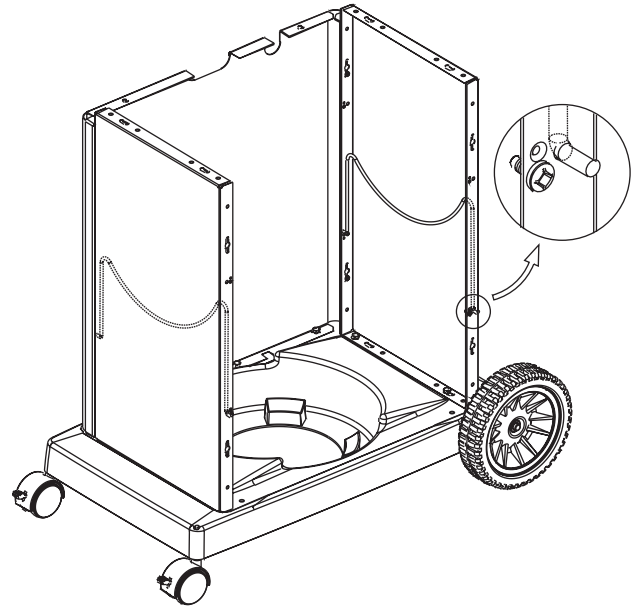
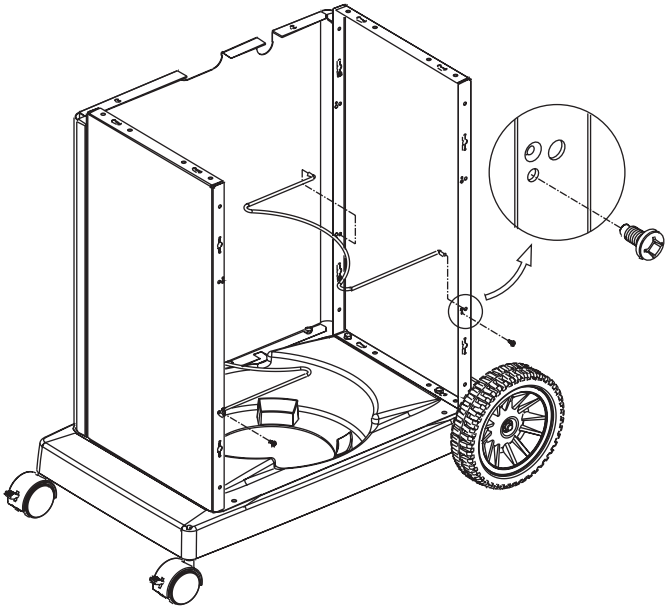

7

(2)



(2)

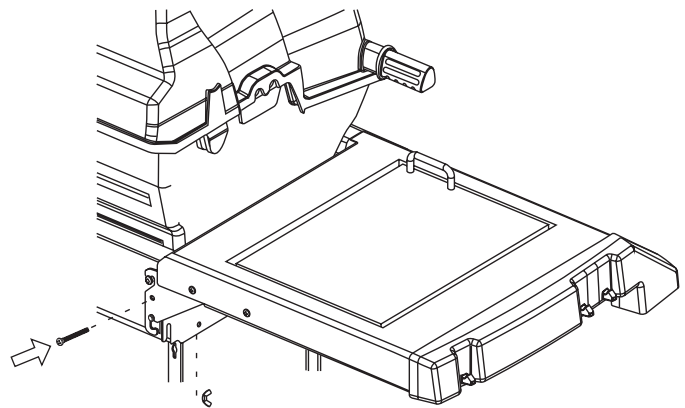
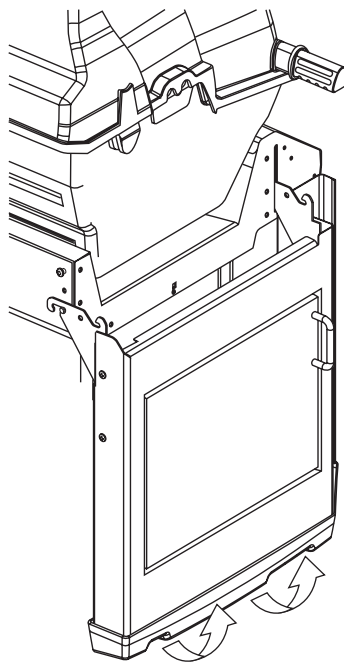
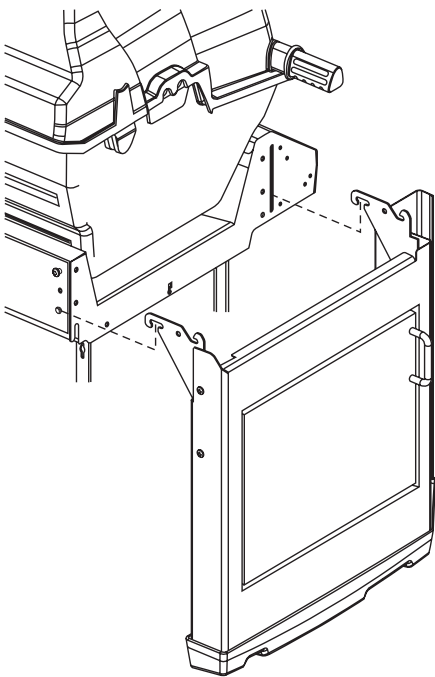
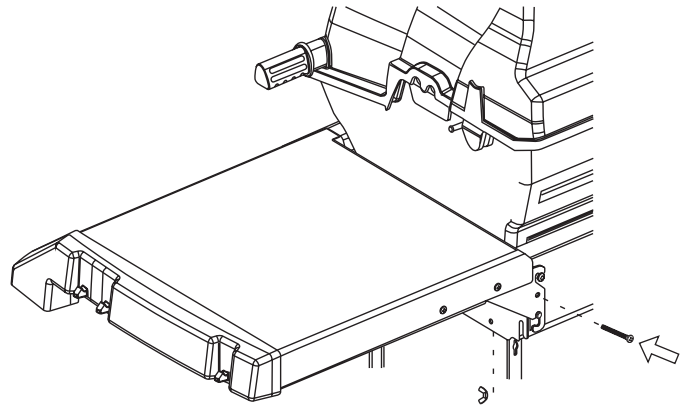
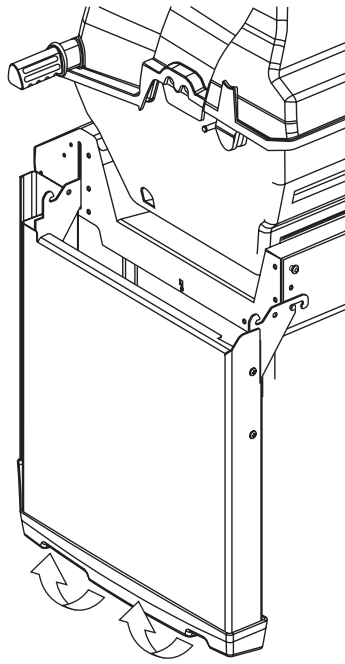
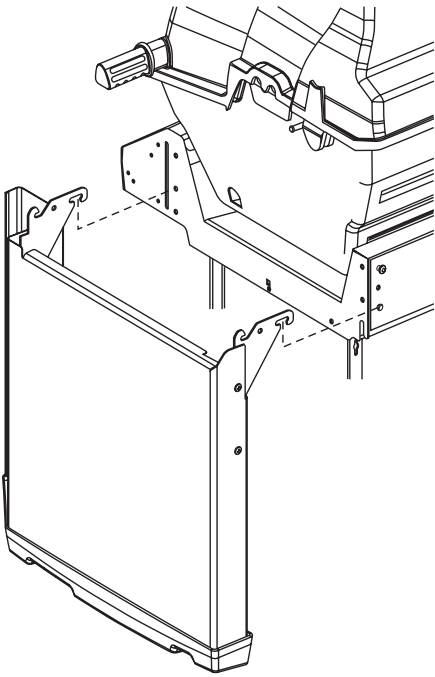
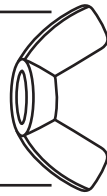

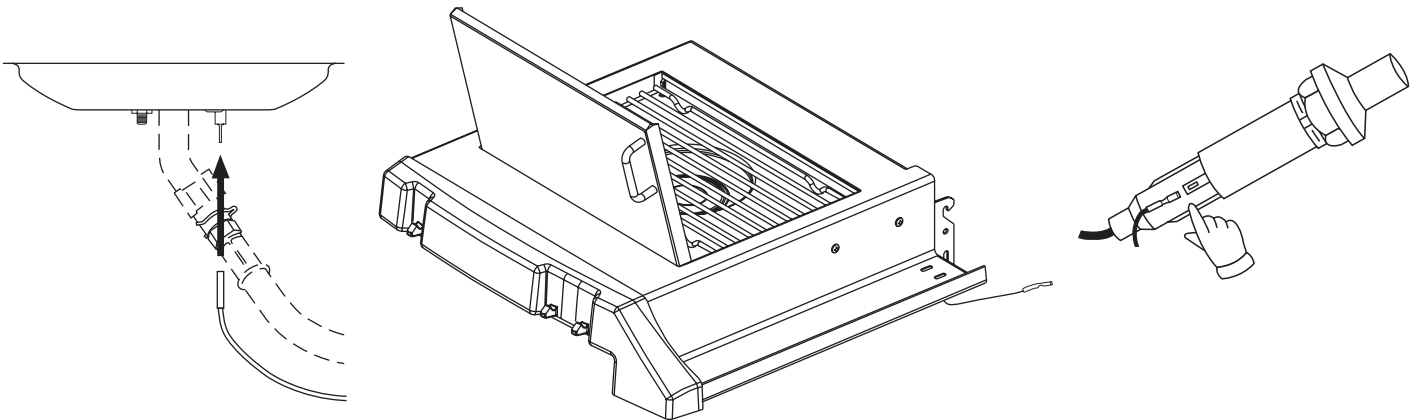
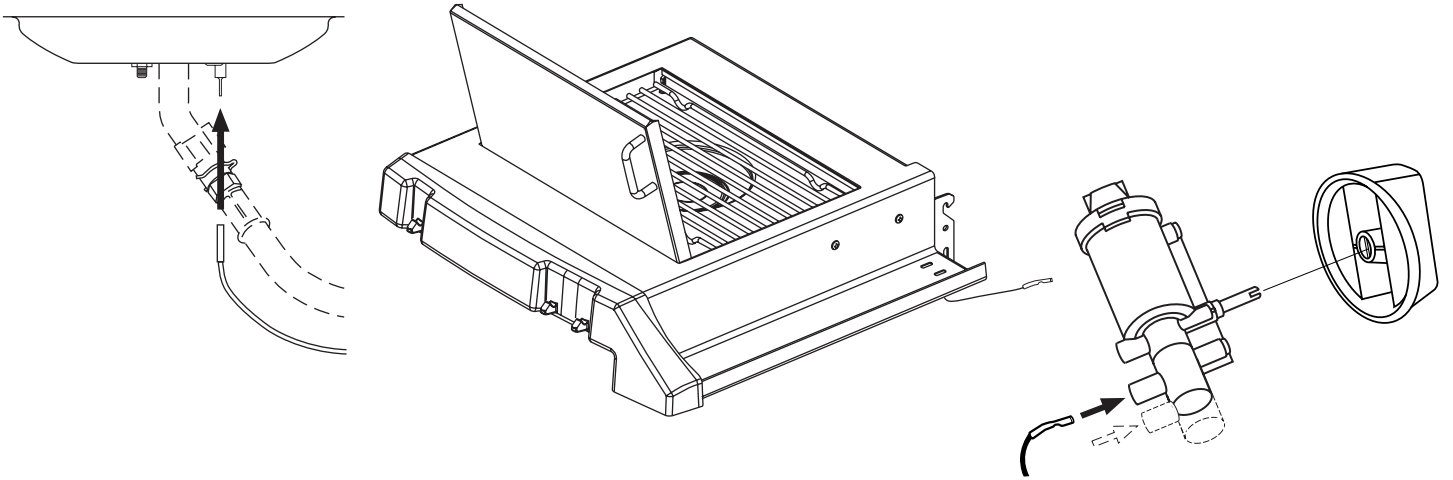
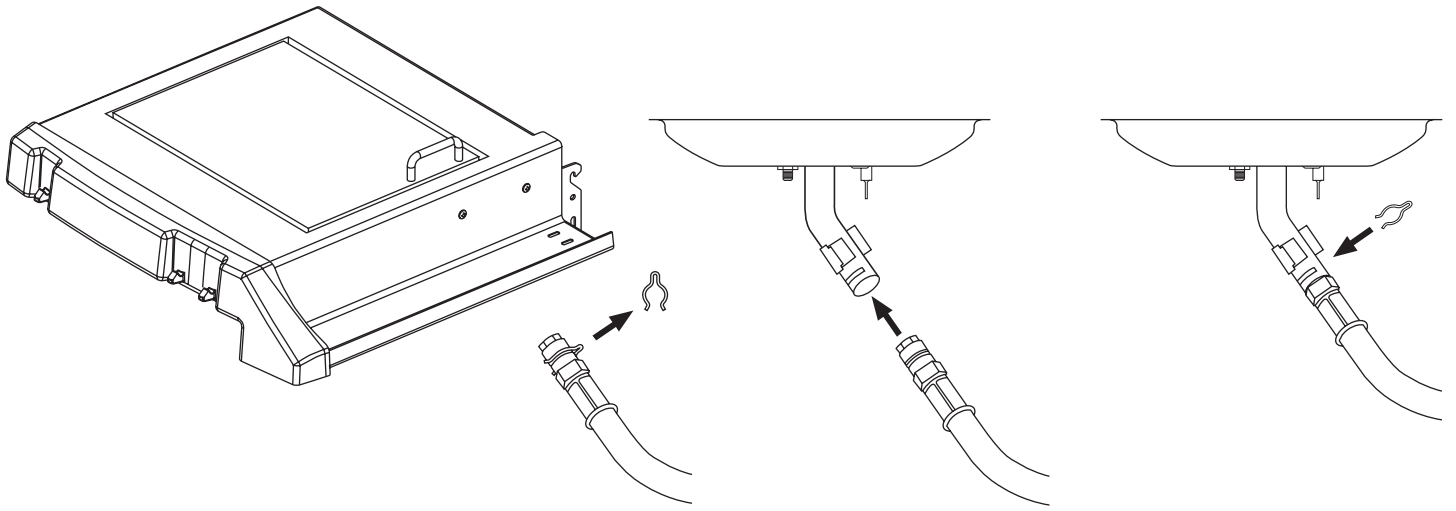

8

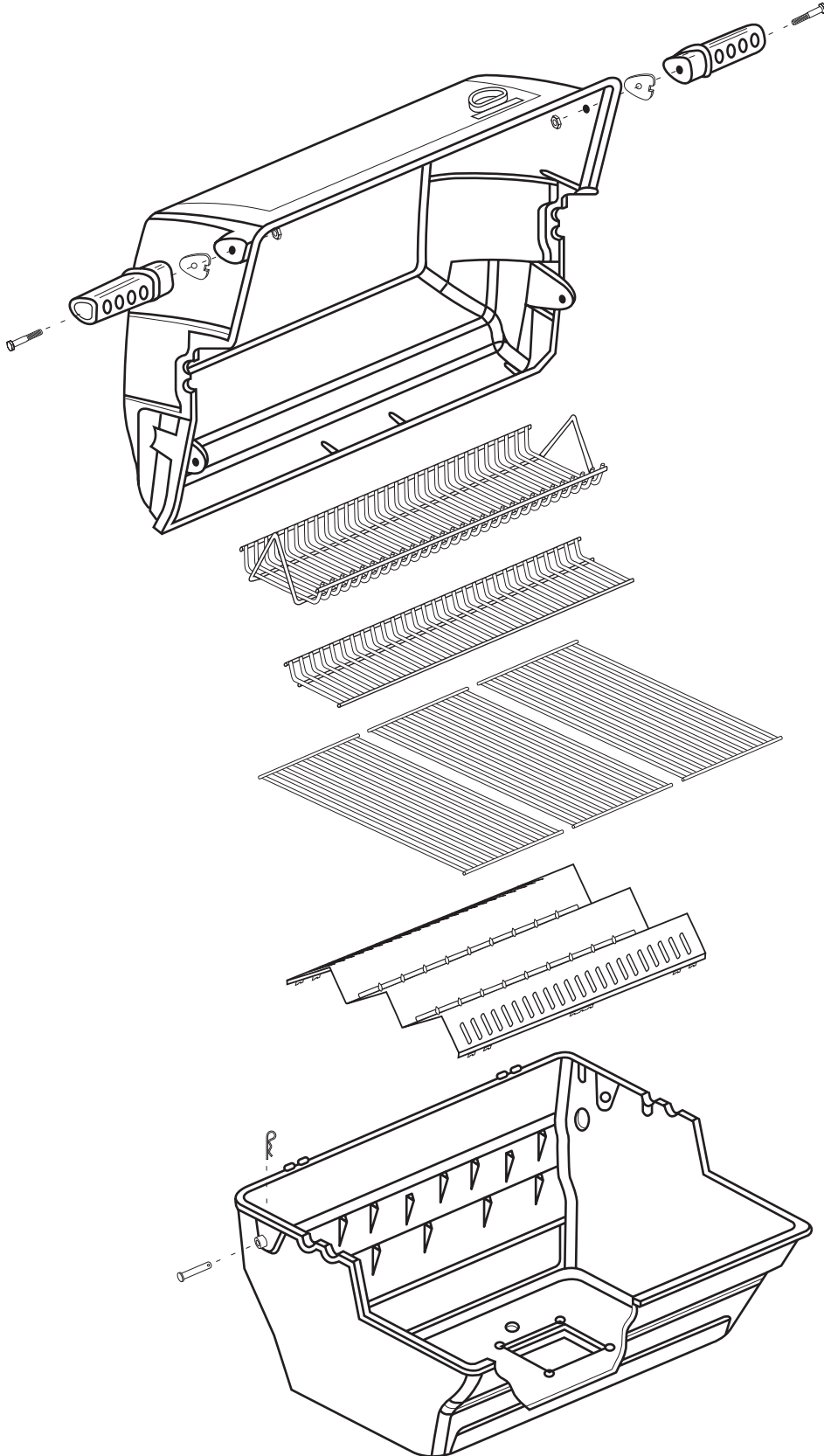
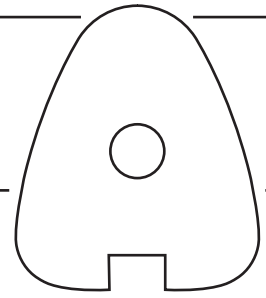
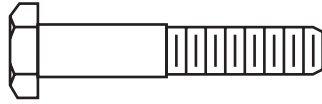
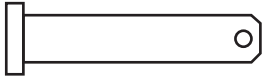

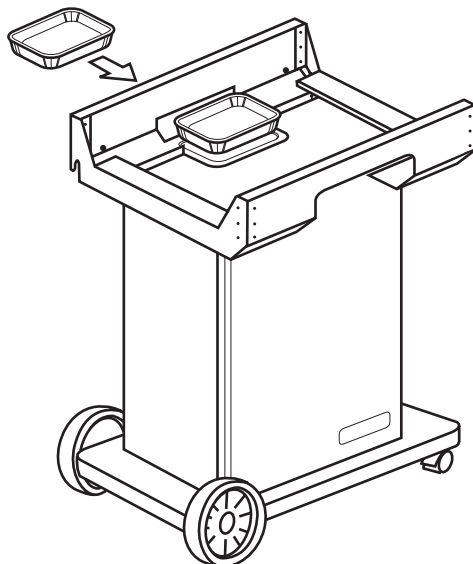
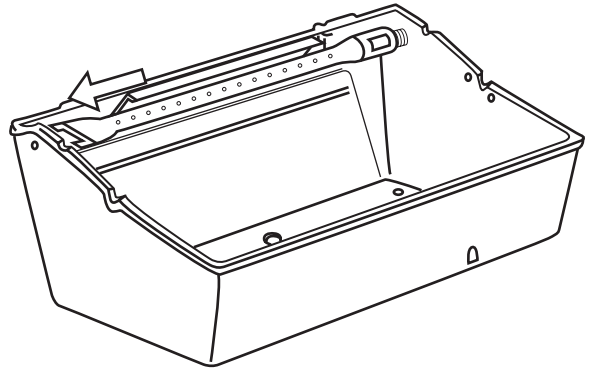
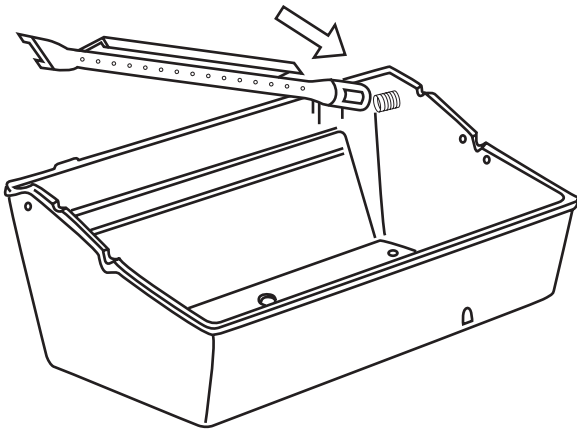
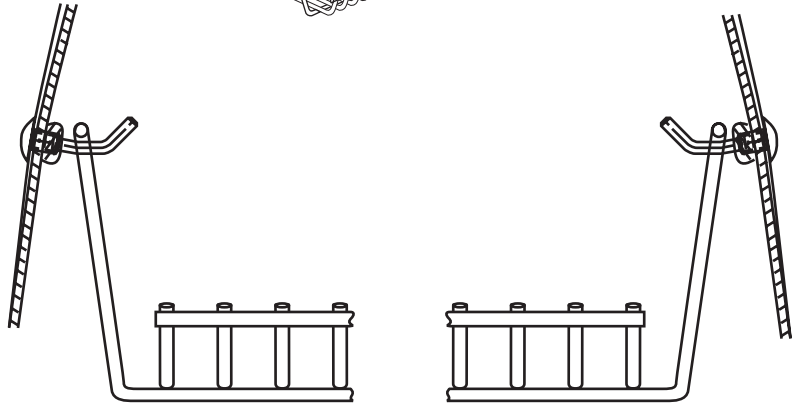
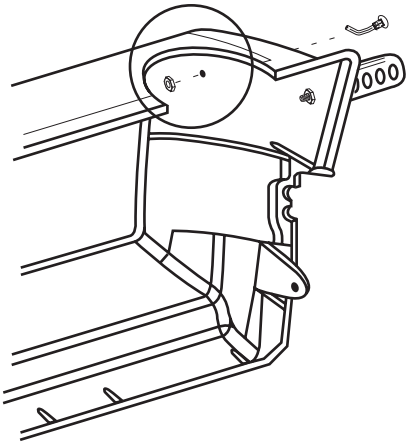
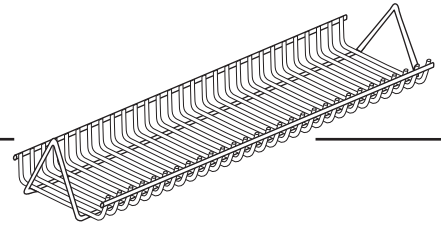
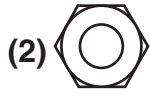

PARTS LIST/LISTE DES PIECES

KEY #	ITEM #	DESCRIPTION	DESCRIPTION	961-74	961-77	961-94	961-97
1.	10909-T50	CASTING BOTTOM	FOND DU FOYER	1	1	1	1
2.	10473-T50	CASTING TOP	COUVERCLE DU GRIL	1	1	1	1
3.	10081-BK603	NAMEPLATE	PLAQUE D'IDENTIFICATION	1	1	1	1
3A.	10081-BK601	NAMEPLATE	PLAQUE D'IDENTIFICATION	1	1	1	1
4.	10958-K70	TOP CASTING INSERT	PANNEAU DE COUVERCLE	1	1	1	1
5.	10571-6	HEAT INDICATOR	INDICATEUR DE CHALEUR	1	1	1	1
6.	10240-15	HINGE PIN	ATTACHE DE CHEVILLE	2	2	2	2
6A.	S21237	HINGE PIN SPACER	ESPACEUR DE CHEVILLE CHARNIERES	2	2	2	2
7.	S21233	HITCH PIN CLIP	ATTACHE DE CHEVILLE	2	2	2	2
9.	S12033S	GRID – S.S.	GRILLE – A.I.	3	3	3	3
10.	10222-T425	FLAV-R-WAVE – S.S.	FLAV-R-WAVE - A.I.	1	1	1	1
11.	10225-T528	GRID - WARMING RACK	GRILLE	1	1	1	1
12.	10225-T627	SWING BASKET	PANIER À BALANCOIR	1	1	1	1
13.	Y-11797	BOLT SWING BASKET	BOULON POUR PANIER A BALANCOIR	2	2	2	2
15.	10390-T501	BURNER/VENTURI ASSY	ENSEMBLE DE BRULEUR	1	1	1	1
17.	10342-242	ROTARY IGNITOR	ALLUMEUR ROTATIF	1	1	.	.
	10342-243	ROTARY IGNITOR	ALLUMEUR ROTATIF	.	.	1	1
	10472-K40	ROTARY IGNITOR KNOB	BOUTON ROTATOIRE D'IGNITOR	1	1	1	1
18.	10342-T301	ELECTRODE	ELECTRODE	2	2	2	2
21.	10440-R84	CONTROL ASSY LP-3V	SOUPAPE, (GAZ PROPANE)	1	.	.	.
	10440-R85	CONTROL ASSY NG-3V	SOUPAPE, (GAZ NATUREL)	.	1	.	.
	10442-R86	CONTROL ASSY LP-4V	SOUPAPE, (GAZ PROPANE)	.	.	1	.
	10442-R87	CONTROL ASSY NG-4V	SOUPAPE, (GAZ NATUREL)	.	.	.	1
21A.	S13467-091	HOSE-SIDE BURNER LP	TUYAU DU BRULEUR LATERAL PL	.	.	1	.
	S13467-132	HOSE-SIDE BURNER NG	TUYAU DU BRULEUR LATERAL GN	.	.	.	1
	Y-11230	COTTER PIN	ATTACHE DE CHEVILLE	.	.	1	1
21B.	10110-91	TUBE-REAR BURNER ASSY	TUBE DE BRULEUR ARRIERE	1	1	1	1
22.	10114-20	HOSE & REGULATOR LP - QCC1	TUYAU ET REGULATEUR PL - QCC1	1	.	1	.
	10111-K47	HOSE NATURAL GAS	TUYAU (GAZ NATUREL)	.	1	.	1
23.	10472-K37	CONTROL KNOB	BOUTON DE CONTROLE	3	3	4	4
30A.	10081-BK609	NAMEPLATE	PLAQUE D'IDENTIFICATION	1	1	1	1
31.	10194-D77	CONTROL COVER	PANNEAU DE CONTROLE	1	1	.	.
	10194-D79	CONTROL COVER	PANNEAU DE CONTROLE	.	.	1	1
33.	10184-R801	RADIATION SHIELD	ÉCRAN DE CHALEUR	1	1	1	1
35.	10184-K651	SUPPORT-CASTING-LEFT	SUPPORT GAUCHE DU FOYER	1	1	1	1
36.	10184-K661	SUPPORT-CASTING-RIGHT	SUPPORT DROIT DU FOYER	1	1	1	1
37.	10184-K6	SUPPORT-SIDE SHELF	SUPPORT TABLETTE	4	4	4	4
39.	10958-R831	BRACE-REAR	SUPPORT ARRIERE	1	1	1	1
40.	10958-R81	BASE	TABLETTE INFERIEURE	1	1	1	1
41.	10958-K851	BRACE-FRONT	SUPPORT AVANT	1	1	1	1
42.	10958-K89	FRONT PANEL – S.S.	PANNEAU AVANT – A.I.	1	1	1	1
43.	10958-R87	SIDE PANEL – S.S.	PANNEAU LATERALE – A.I.	2	2	2	2

PARTS LIST/LISTE DES PIECES

KEY #	ITEM #	DESCRIPTION	DESCRIPTION	961-74	961-77	961-94	961-97
47.	10184-R19	TANK RETAINER	SERVITEUR DU RESERVOIR	2	2	2	2
50.	10711-K61	SHELF-SIDE-RIGHT	PLANCHETTE LATÉRALE – DROIT	1	1	1	1
50A.	10711-K612	SHELF - END CAP	ÉTAGÈRE - MONTURE D'EMBOUT	1	1	1	1
51.	10711-K62	SHELF-SIDE-LEFT	PLANCHETTE LATÉRALE – GAUCHE	1	1	·	·
	10711-K63	SHELF-SIDE-BURNER	PLANCHETTE – BRULEUR DE COTE	·	·	1	1
51A.	10711-K622	SHELF - END CAP	ÉTAGÈRE - MONTURE D'EMBOUT	1	1	1	1
56.	10892-8	WHEEL	ROUE	2	2	2	2
65.	S13008	BURNER ROTISSERIE	BRULEUR A ROTISS	1	1	1	1
68.	S21362	SPRING	RESSORT	1	1	1	1
70.	Y-11990	HEX NUT	ECROU	1	1	1	1
71.	10696-109	REARBURNER-ORIFICE LP	ORIFICE DU BRULEUR ARRIERE PL	1	·	1	·
	10696-160	REARBURNER-ORIFICE NG	ORIFICE DU BRULEUR ARRIERE GN	·	1	·	1
73.	S21420	PUSH NUT	POUSSE ECROU	2	2	2	2
74.	Y-6616	BOLT 1/4-20 X 1 1/2	BOULON – 1/4-20 X 1 1/2	2	2	2	2
75.	10338-145	HANDLE	POIGNEE	2	2	2	2
76.	10239-6	WASHER-HANDLE	RONDELLE DE LA POIGNEE	2	2	2	2
78.	10892-15	CASTOR	ROULETTES	2	2	2	2
79.	Y-11561	BOLT – 1/4-20 x 1 3/4	BOULON - 1/4-20 X 1 3/4	2	2	2	2
80.	Y-11546	BOLT – 1/4-20 X 5/8	BOULON - 1/4-20 X 5/8	8	8	8	8
81.	Y-11545	SCREW – 1/4-20 X 1 3/8	VIS – 1/4-20 X 1 3/8	4	4	4	4
82.	Y-12860	SCREW - 1/4-20 X 1	VIS – 1/4-20 X 1	2	2	2	2
82A.	Y-12855	SCREW - 1/4-20 X 3/8	VIS – 1/4-20 X 3/8	14	14	14	14
83.	S21014	BOLT - 1/4-20 X 3/4	BOULON – 1/4-20 X 3/4	8	8	8	8
84.	S15171	AXEL	ESSIEU	1	1	1	1
86.	Y-11795	NUT – LOCKING – 1/4-20	ECROU – SERRURE – 1/4-20	8	8	8	8
87.	Y-11793	NUT- 1/4-20	ECROU – 1/4-20	18	18	18	18
88.	Y-11598	NUT-WING – 1/4-20	ECROU-PAPILLON – 1/4-20	2	2	2	2
97.	Y-12642	SCREW – 8 X 1/2 – S.S.	VIS - 8 X 1/2 – A.I.	6	6	6	6
98.	S21124	SCREW – 8 X 1/2	VIS - 8 X 1/2	18	18	18	18
98A.	S21124S	SCREW – 8 X 1/2 S.S.	VIS - 8 X 1/2 S.S.	2	2	2	2
99.	Y-12646	SCREW – SHOULDER 8 X 1/2	VIS - 8 X 1/2	·	·	2	2
104	Y-12835	SCREW – 6-32 X 1/4	VIS – 6-32 X 1/4	·	·	2	2
105.	Y-29307	NUT – 10-24	ECROU – 10-24	·	·	4	4
108.	PB20-60	LID HANDLE	POIGNEE	·	·	1	1
109.	S21136	SCREW – 8-32 X 3/8	VIS – 8-32 X 3/8	4	4	6	6
110.	10225-T10	GRID	GRILLE	·	·	1	1
111.	10390-E10	SIDE BURNER	BRULEUR DE COTE	·	·	1	1
113.	10342-T14	ELECTRODE – SIDE BURNER	ELECTRODE – BRULEUR DE COTE	·	·	1	1
114.	10393-K40	COVER-SIDE BURNER	COUVERCLE LATÉRAL	·	·	1	1
115.	Y-29305S	SCREW – 10-24 X 3/8	VIS– 10-24 X 3/8	4	4	8	8
117.	10393-R50	SHELF-SIDE BURNER	SUPPORT DE BRULEUR DE COTE	·	·	1	1
123.	S15115	GREASE PAN - DISPOSABLE	CUVETTE A GRAISSE	2	2	2	2
124.	Y-12083	NUT – LOCKING – 10-24	ECROU – SERRURE – 10-24	8	8	8	8
125.	Y-12848	SCREW – 10-24 X 1/2	VIS– 10-24 X 1/2	8	8	8	8

