

This Owner's Manual is provided and hosted by [Appliance Factory Parts](#).



# Broil King 970-77 Owner's Manual

[Shop genuine replacement parts for Broil King 970-77](#)



[Find Your Broil King Grill Parts - Select From 1350 Models](#)

----- Manual continues below part list -----

## Available Replacement Parts for Broil King 970-77

<a href="#">18434</a>	INFINITY BURNER T501
<a href="#">10892-8NG</a>	WHEEL 8 INCH GREY WALL
<a href="#">10225-T628</a>	GRID FLAT WARMING RACK DELUXE+
<a href="#">10225-T627</a>	GRID SWING BASKET IMPERIAL BLACK
<a href="#">11115</a>	CI COOKING GRID - T626
<a href="#">10342-T301</a>	IGNITOR ELECTRODE ASSEMBLY 8 BURNER 1993
<a href="#">10711-r562</a>	SHELF LEFT C LG W/O BRACKET +
<a href="#">10222-T626</a>	GRATE FLAV R CAST IMPERIAL +
<a href="#">18013</a>	LARGE PROBE HEAT INDICATOR
<a href="#">10225-T10</a>	GRID PORCELAIN S/B
<a href="#">10393-K40</a>	SIDE BURNER COVER 1.86
<a href="#">10081-BK630</a>	NAMEPLATE HI BROIL KING BLACK ZINC
<a href="#">10240-15</a>	HINGE PIN SIDE SHELF DROP DOWN
<a href="#">S21237</a>	HINGE PIN SPACER
<a href="#">10110-91</a>	TUBE R/B ASSY COMPR FITTING
<a href="#">S21124</a>	SCREW PHCP #8 X 12 +
<a href="#">PB20-60A</a>	S/B LID HANDLE WAGON ENCLOSER+ W/SCREWS
<a href="#">10390-E10</a>	BURNER SIDE 10BTU W/ELEC #8 +
<a href="#">10342-T14</a>	WIRE ELECTRODE S/B FLAT/ROUND+
<a href="#">10393-R50</a>	SIDE BURNER BODY 2002 +
<a href="#">10239-7</a>	HANDLE GASKET TRIANGULAR 1/8
<a href="#">Y-12220</a>	S/B BUSHING SB 1.375 16 HEY
<a href="#">50416</a>	SMALL DRIP PAN - 10 PACK
<a href="#">02342</a>	control knob; universal
<a href="#">10342-246</a>	IGNITOR ELECTRONIC TRIPLE +
<a href="#">10184-R80</a>	RADIATION SHIELD RAW
<a href="#">S13005A</a>	BURNER TUBULAR W/IGNITION
<a href="#">10184-D821</a>	TANK RETAINER BRACKET
<a href="#">10696-127</a>	R/B ORIFICE LP
<a href="#">10696-185</a>	R/B ORIFICE NG 1.85MM

<a href="#">Y-11797</a>	BOLT SWING BASKET #D
<a href="#">10184-R581</a>	SHELF SUPPORT LFT BLK(18 INCH)
<a href="#">10184-R591</a>	SHELF SUPPORT RH BLK(18 INCH)
<a href="#">10892-22</a>	CASTER WHEEL 3/8 16 THREADED
<a href="#">80012</a>	regulator and hose READ ADD. INFO
<a href="#">10342-245</a>	IGNITOR ELECTRONIC DUAL +
<a href="#">10111-K45</a>	HOSE 3/8 INCH ASSEMBLY NG 10 FOOT +
<a href="#">Y-11990</a>	NUT HEX BRASS 3/8 27 RB LINE

# Broil King®

## REDDI-BILT BARBECUES

ASSEMBLY MANUAL & PARTS LIST

MANUEL DE MONTAGE & LISTE DE PIÈCES



**Broil King**

970-74  
970-77



**Broil King**

970-94  
970-97

RETAIN FOR FUTURE REFERENCE

VEUILLEZ CONSERVER POUR REFERENCE ULTERIEURE

*Onward*  
SINCE 1906  
**MANUFACTURING COMPANY**  
LIMITED  
585 KUMPF DRIVE  
WATERLOO, ONTARIO, CANADA  
N2V 1K3

1

(2)

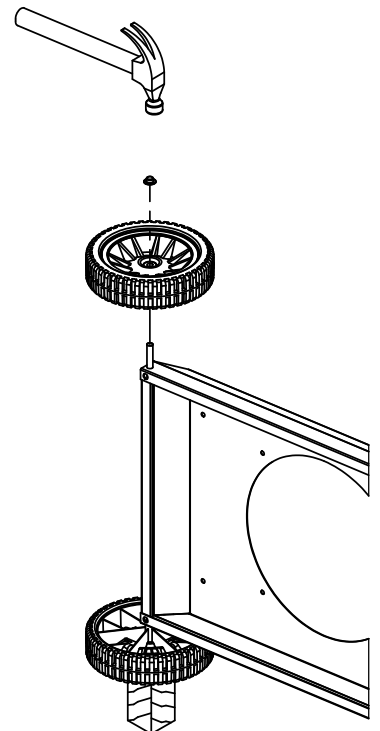
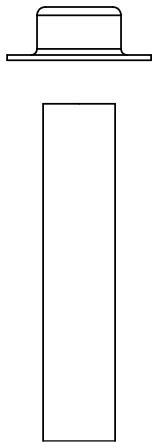
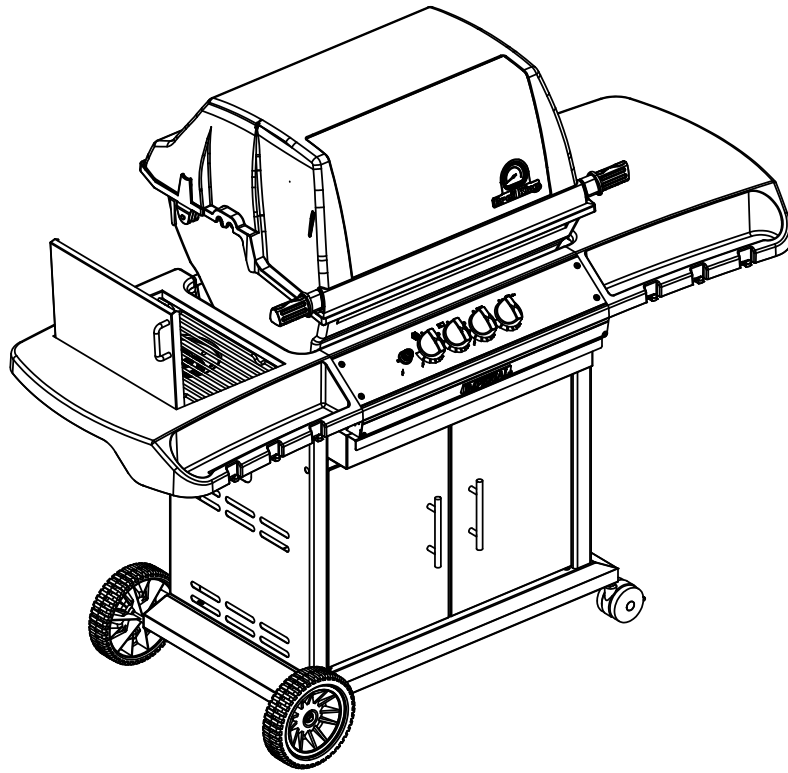
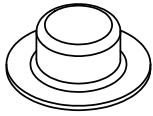

**2**

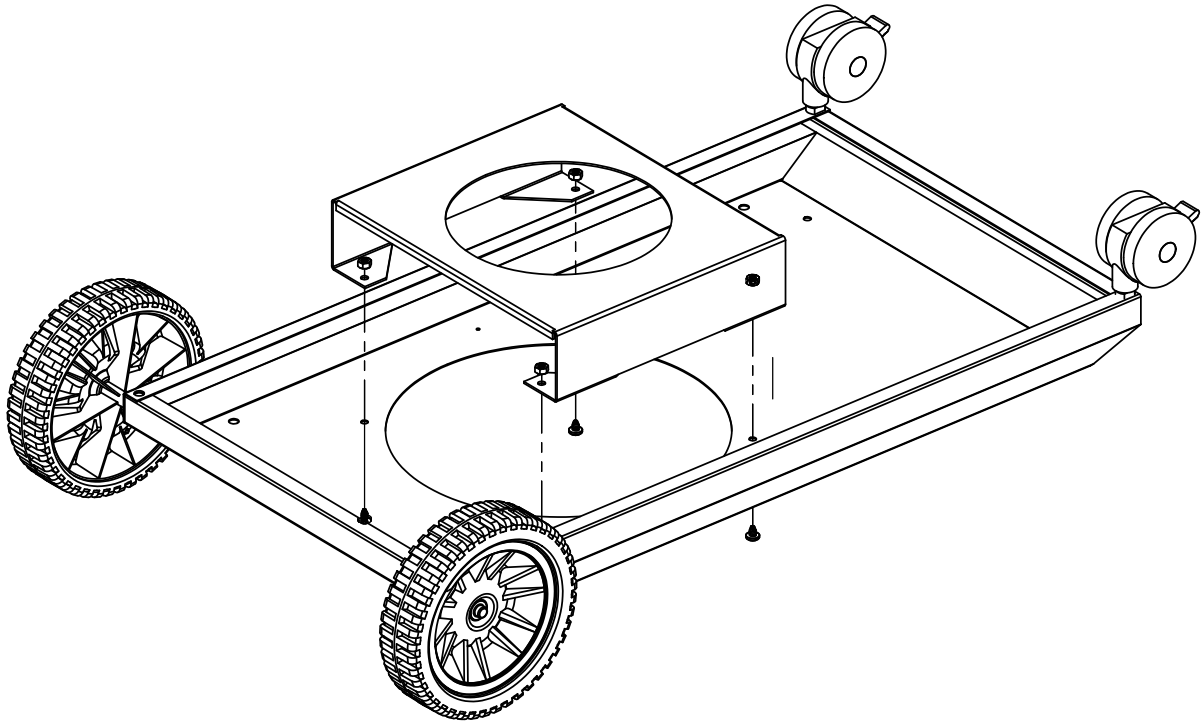
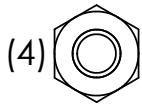
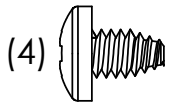

**3**

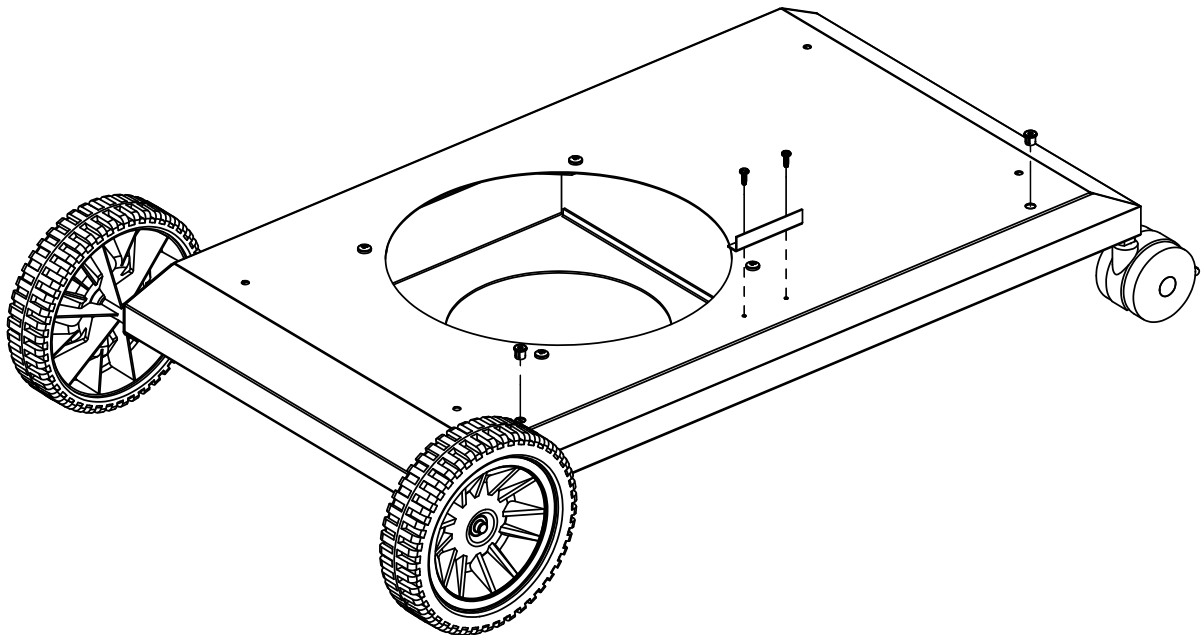
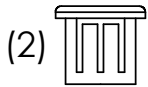
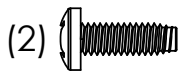

4

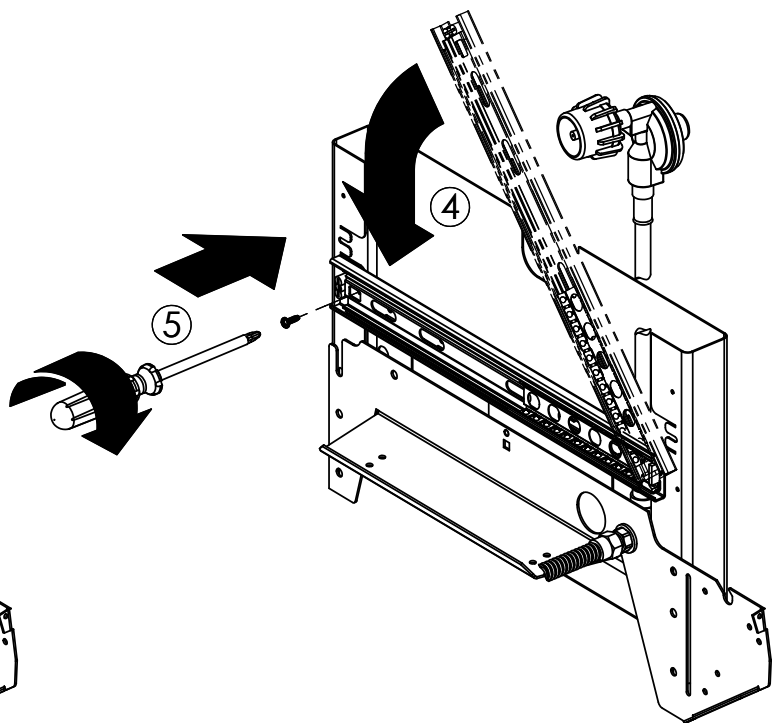
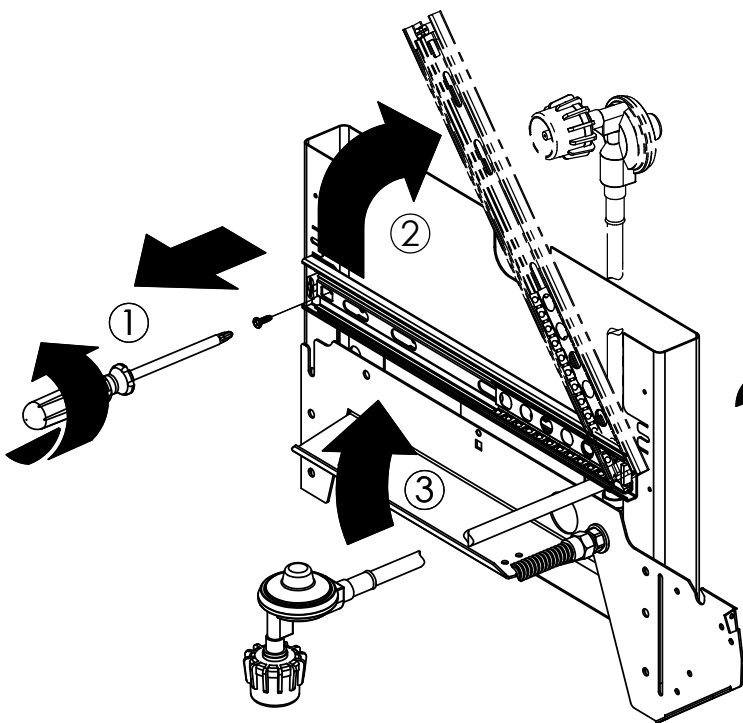
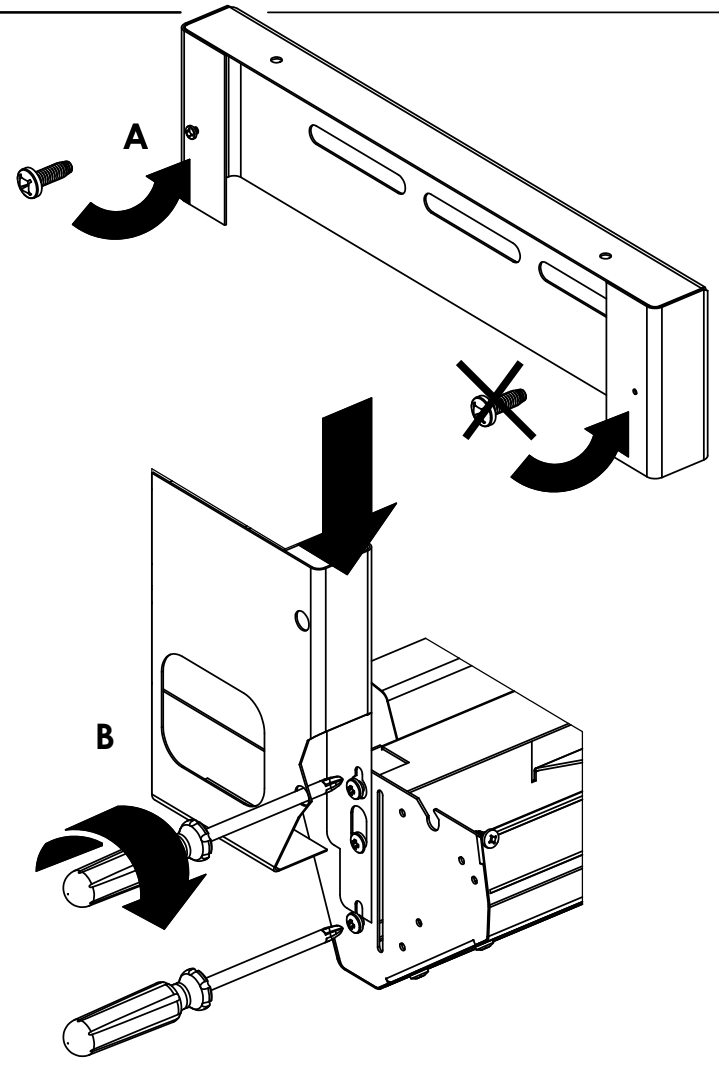
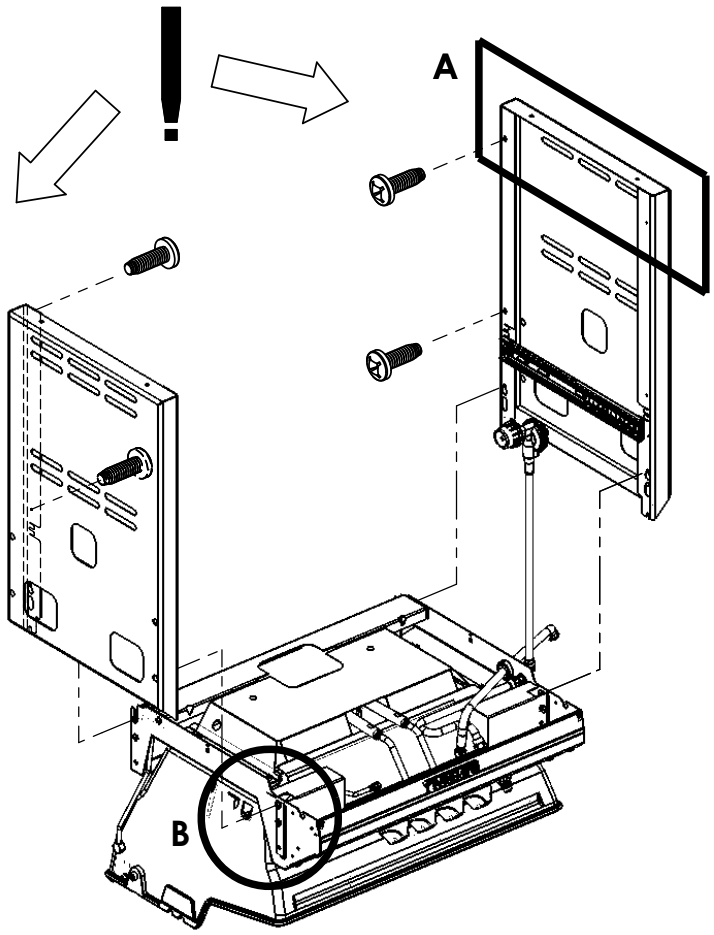

5

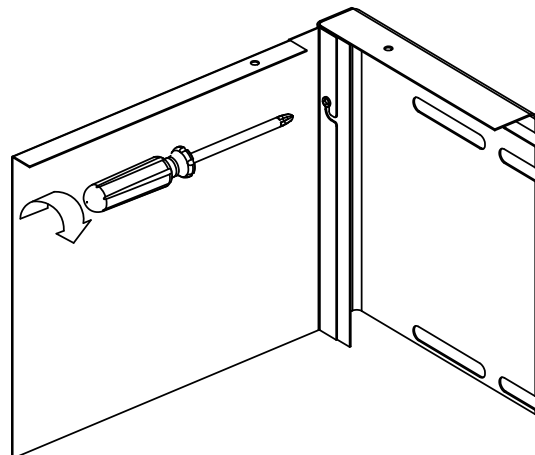
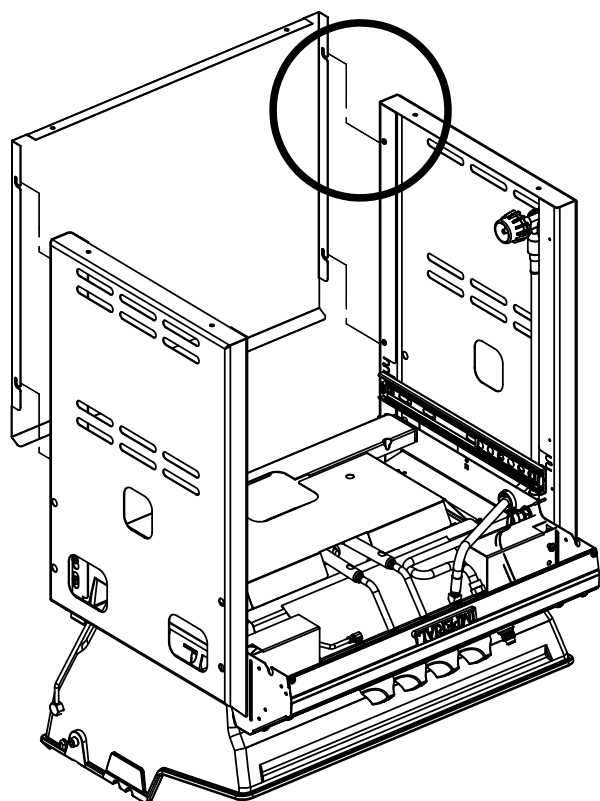

6

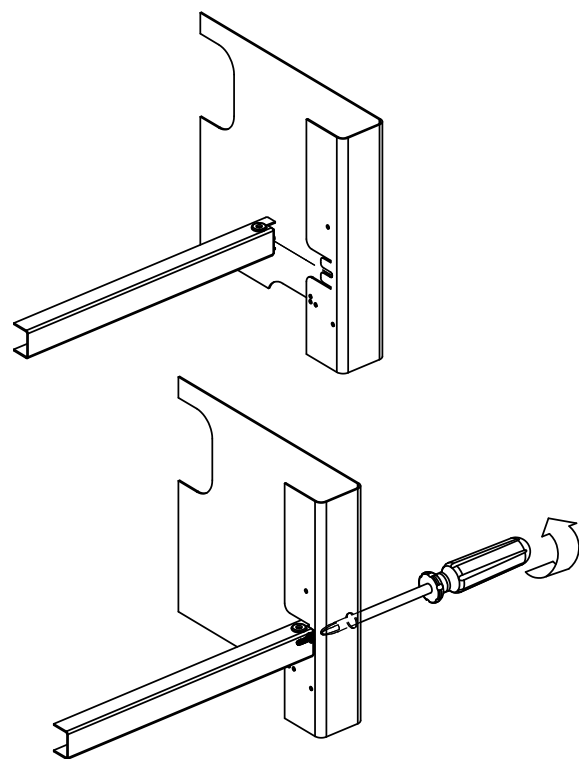
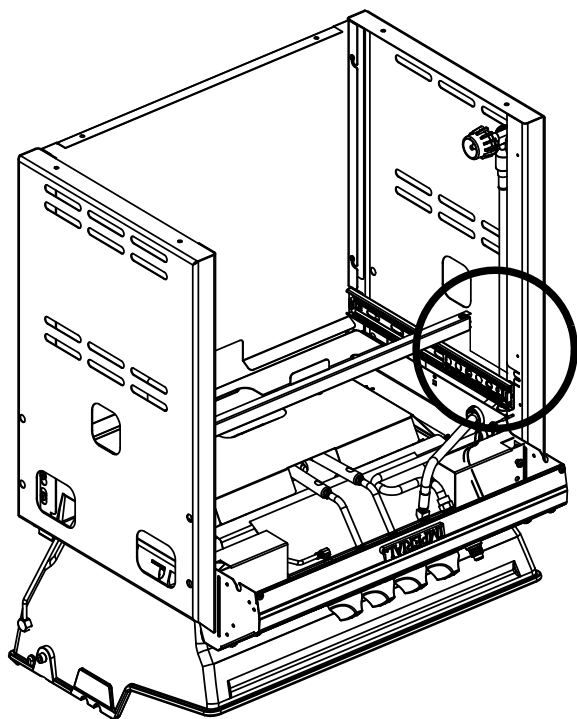



7

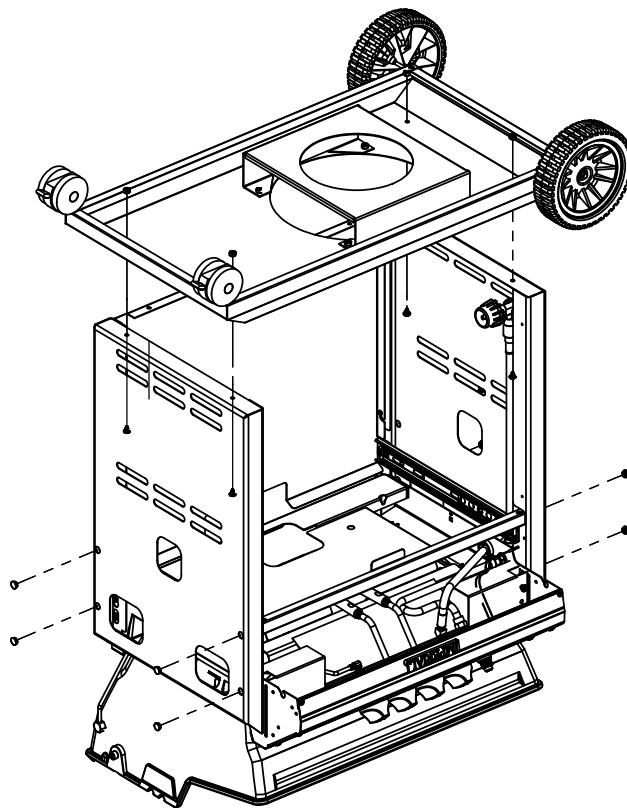
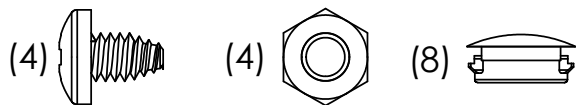

8

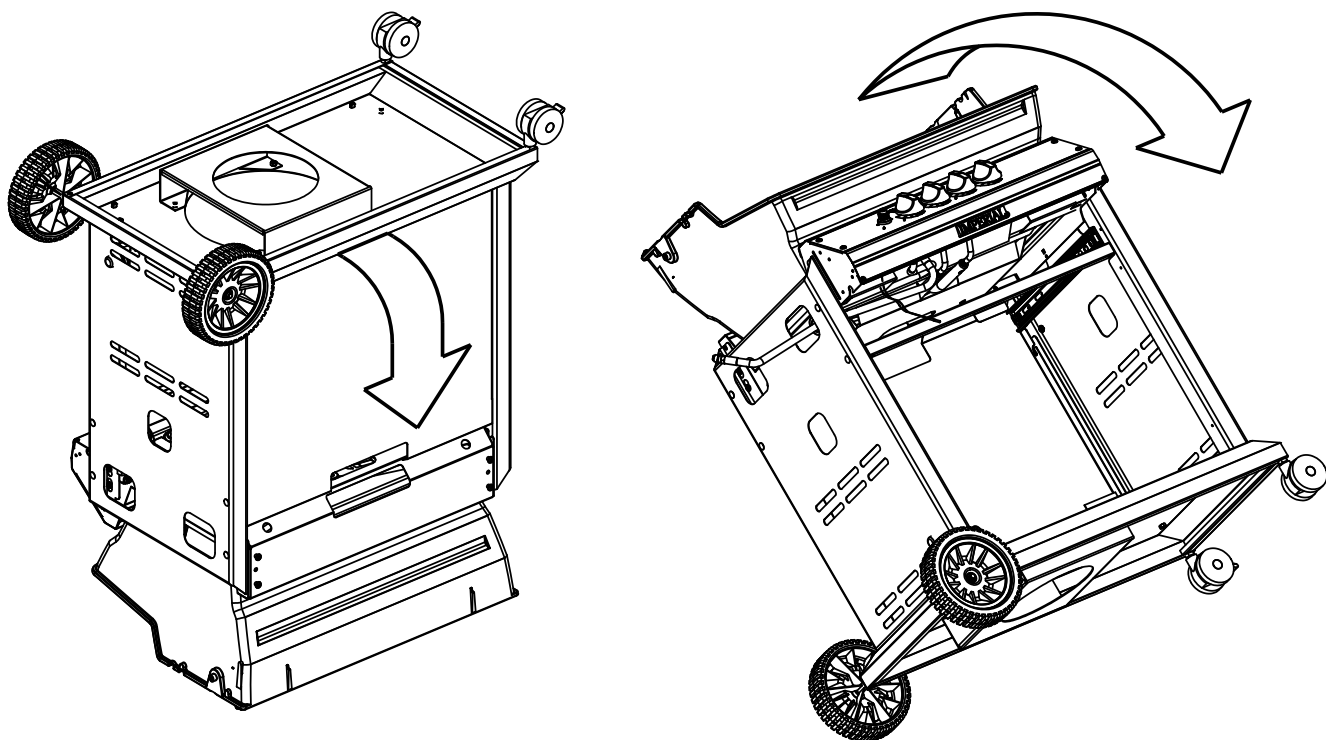

9

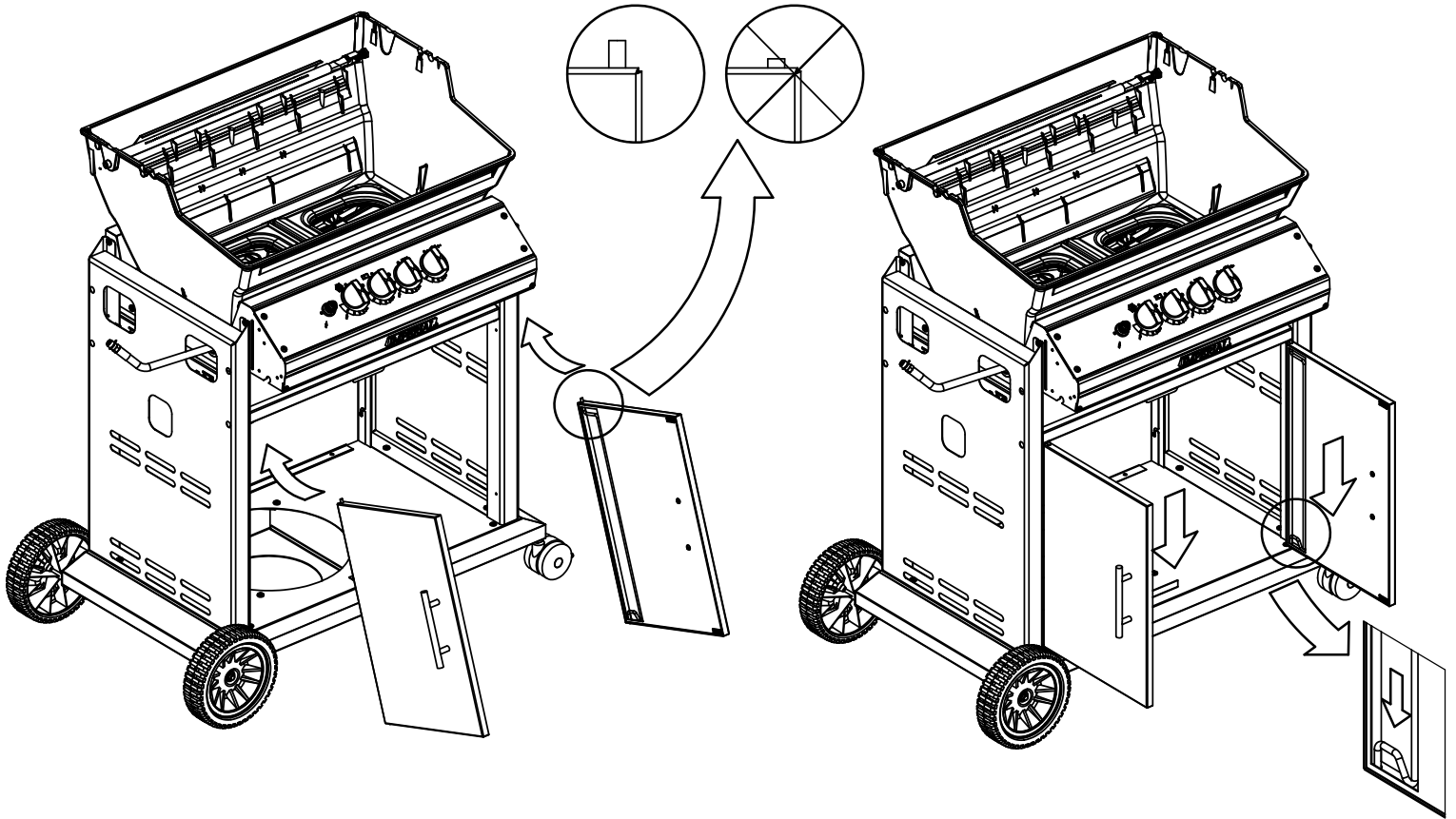

10

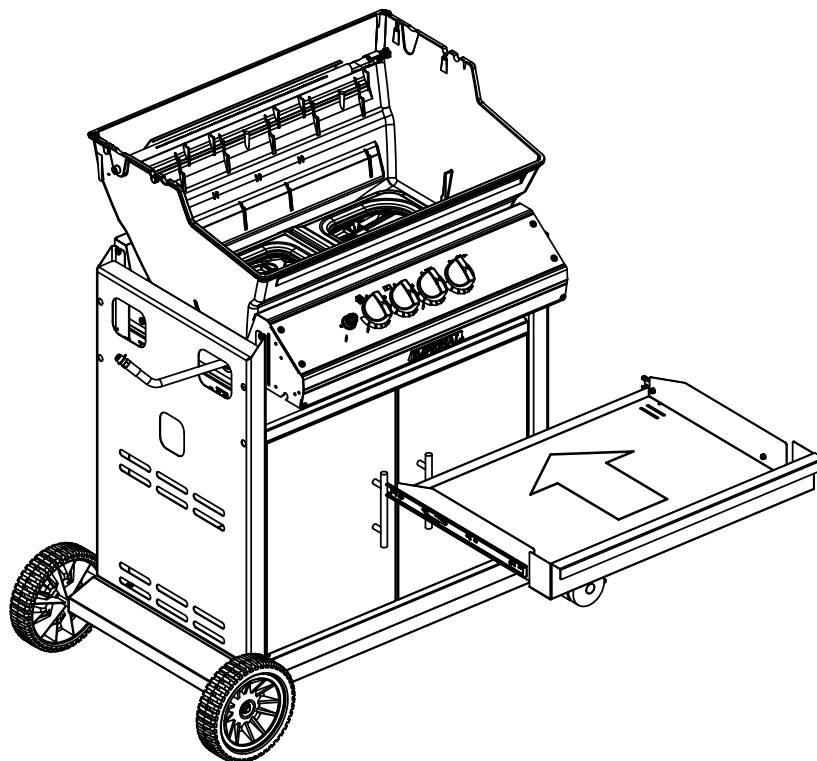

11

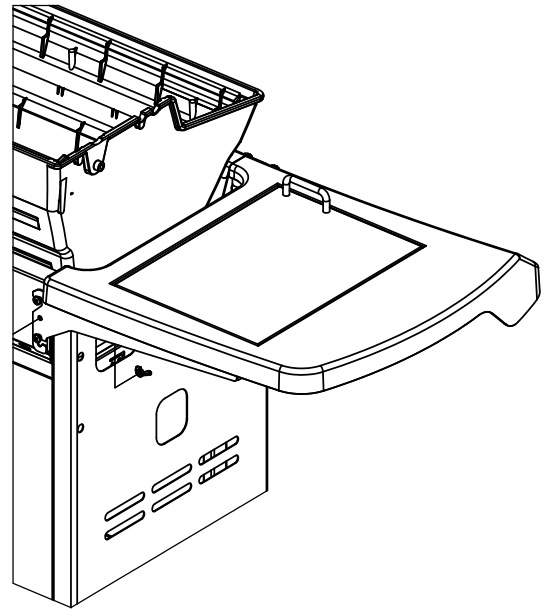
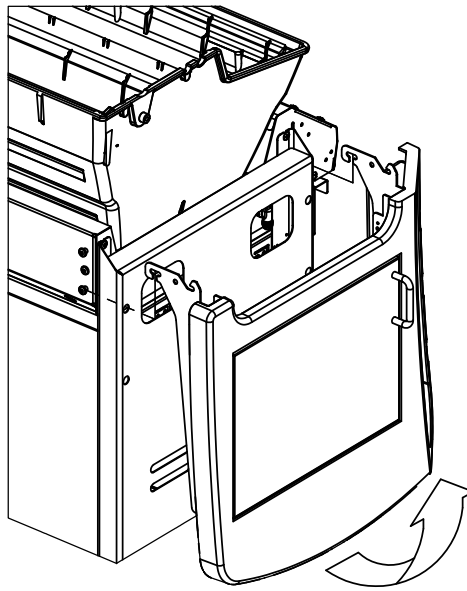
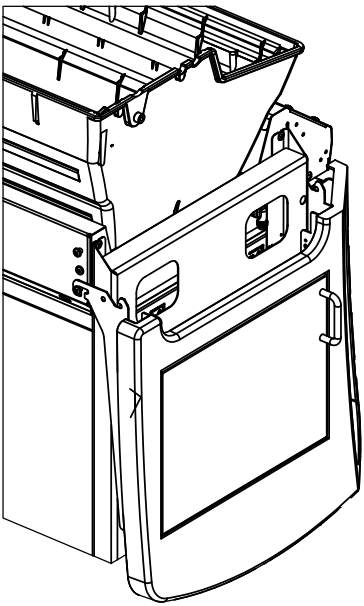
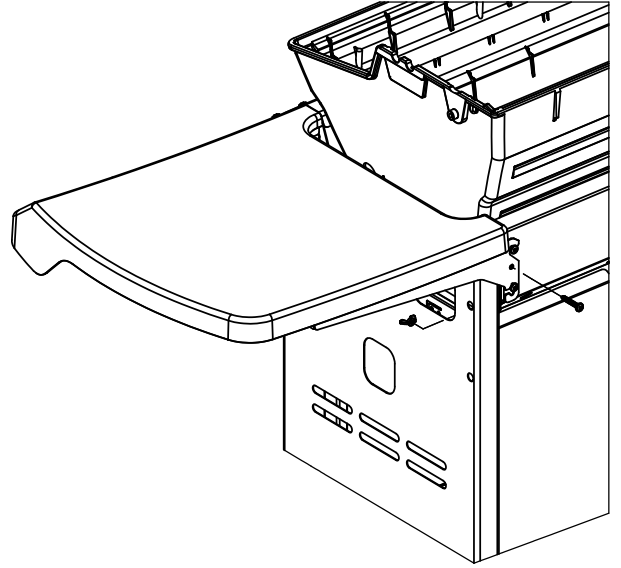
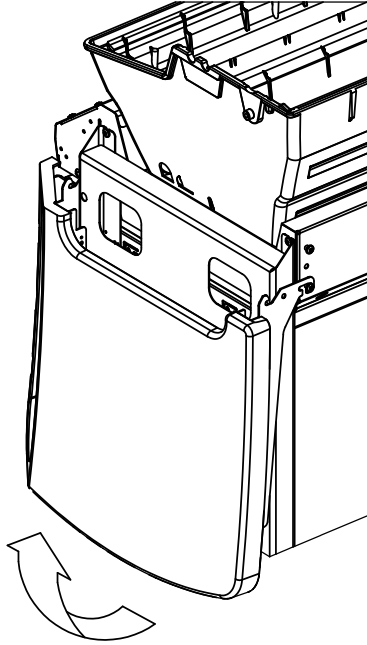
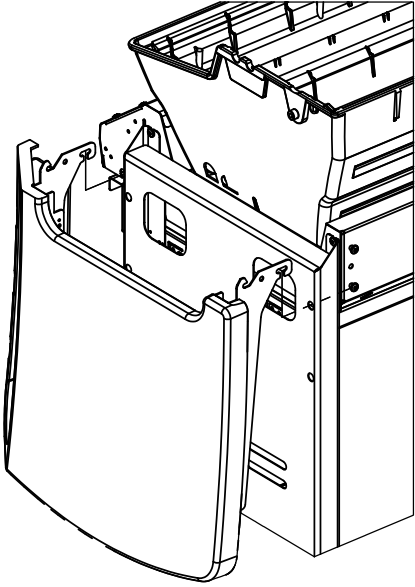
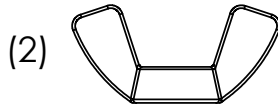
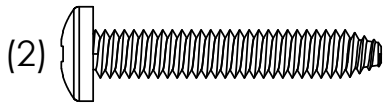

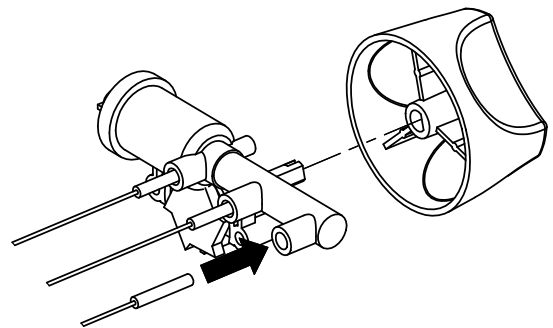
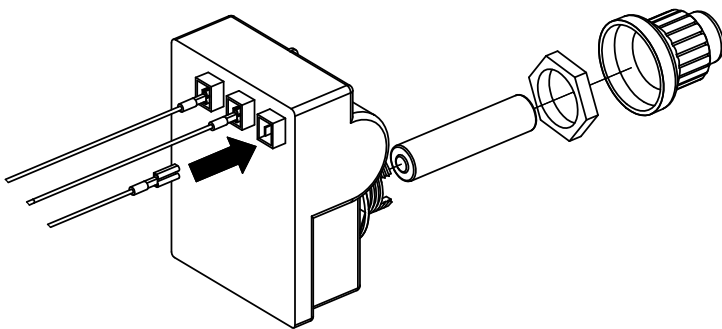
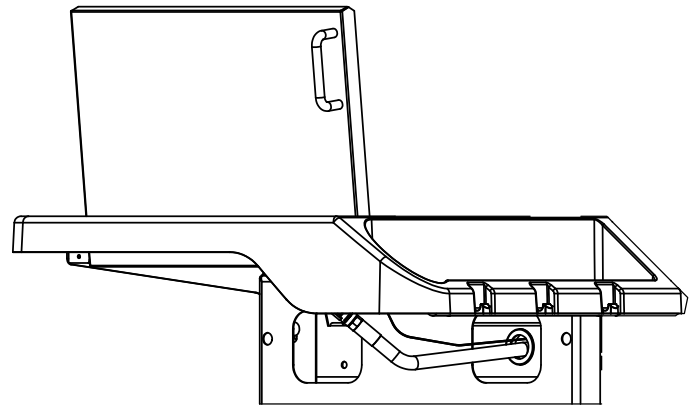
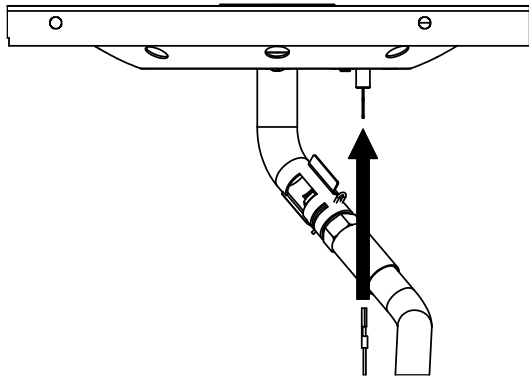
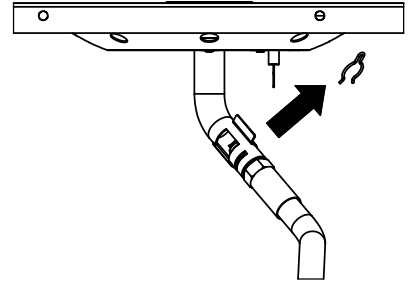
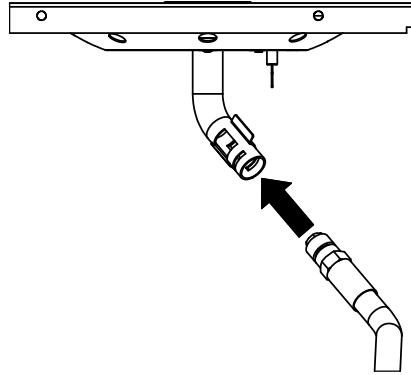
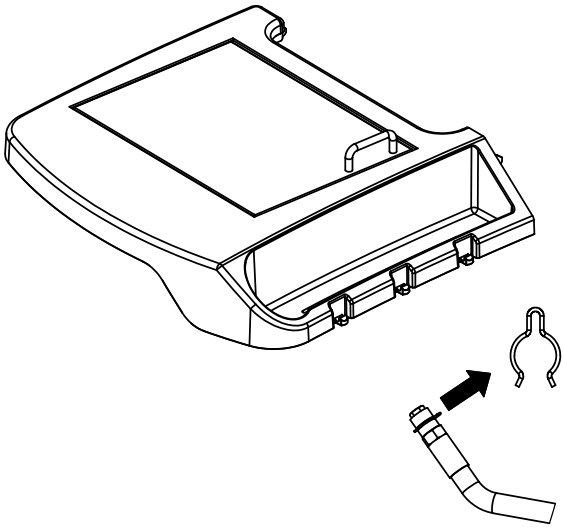

12

(2)

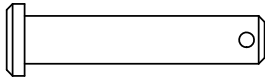

(2)

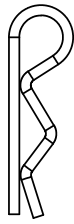

(2)

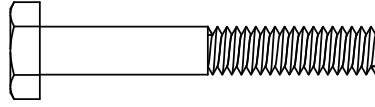

(2)

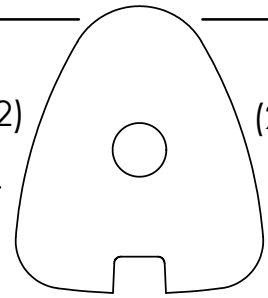

(2)

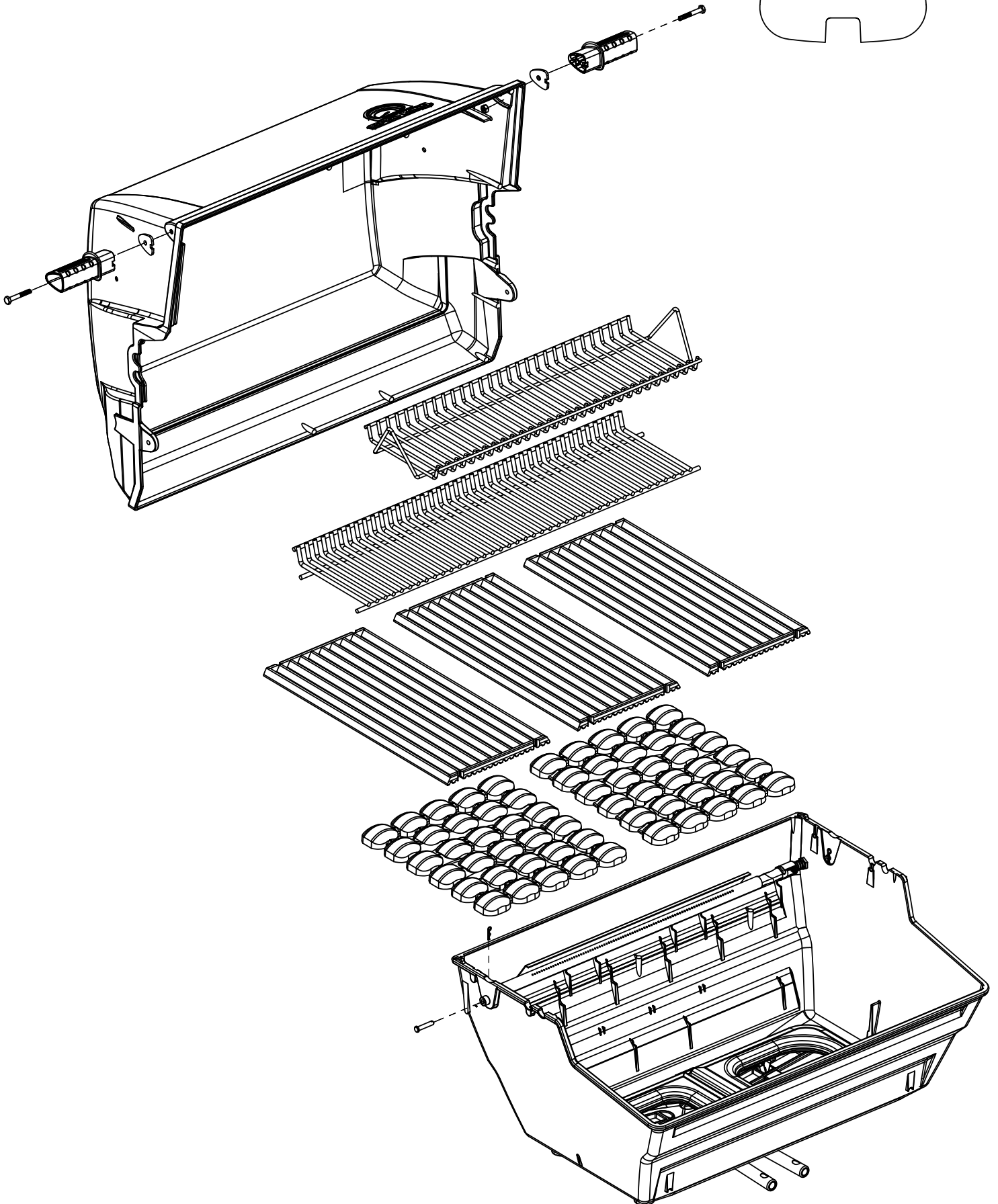
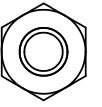

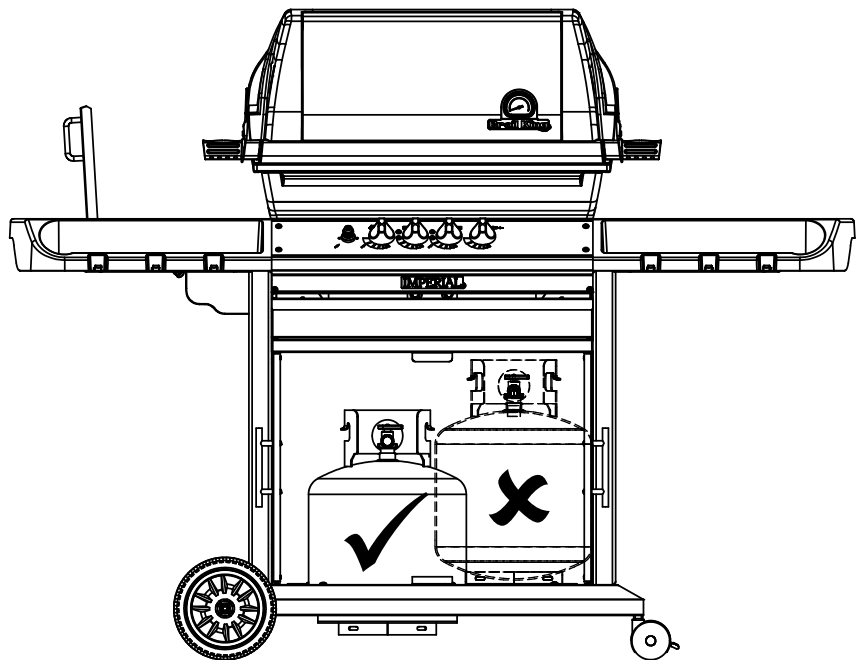
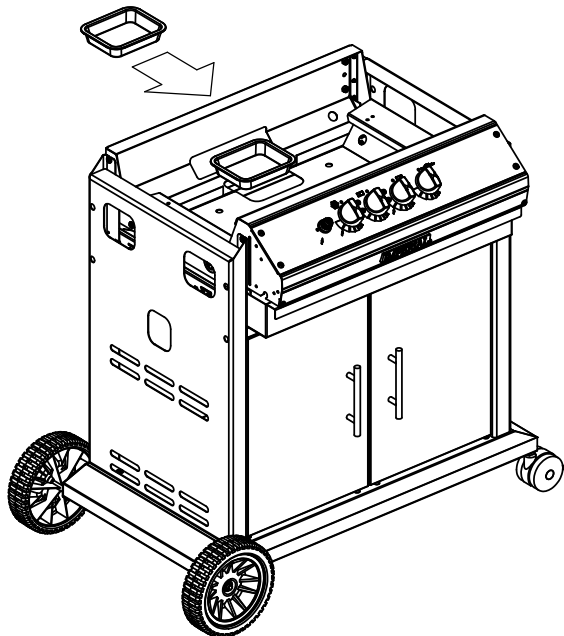
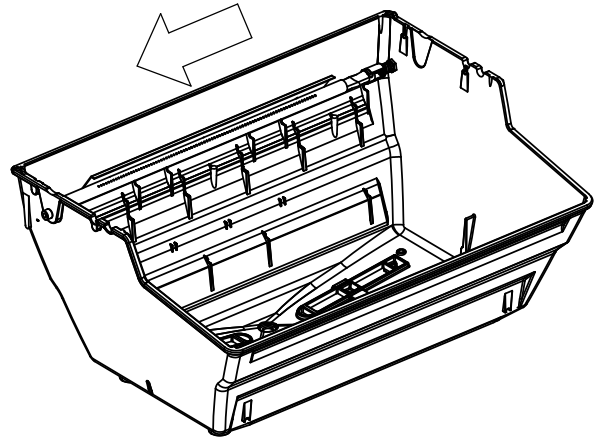
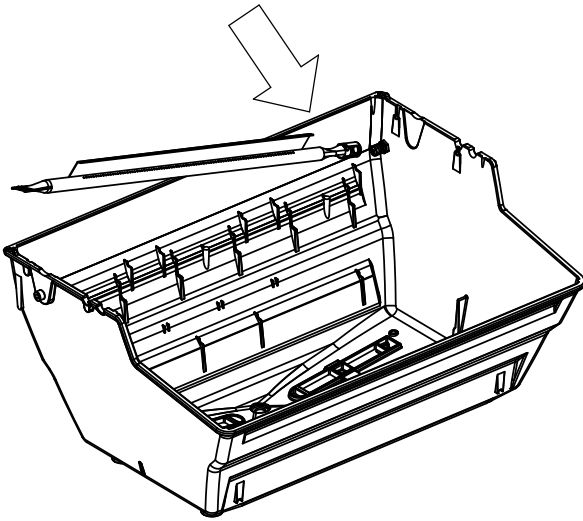
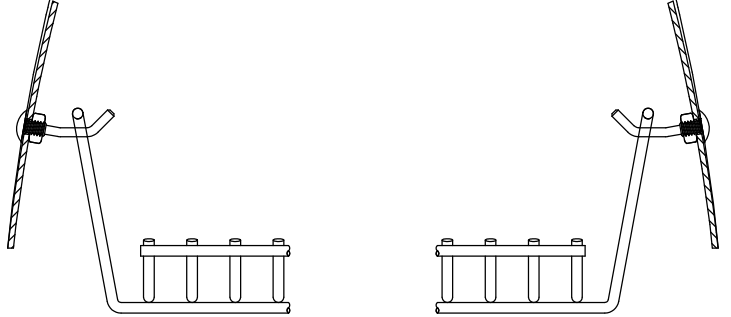
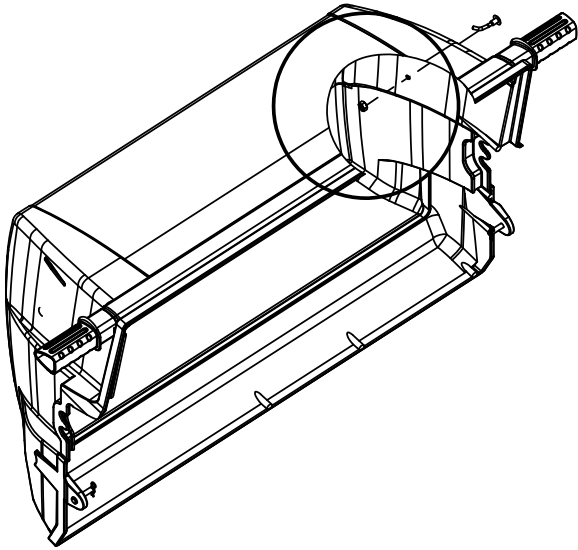
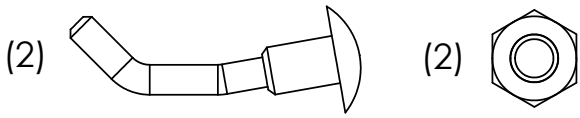

## PARTS LIST/LISTE DES PIÈCES

KEY #	ITEM #	DESCRIPTION	DESCRIPTION	970-74	970-77	970-94	970-97
1	10909-T60	CASTING BOTTOM	FOND DU FOYER	1	1	1	1
2	10473-T60	CASTING TOP	COUVERCLE	1	1	1	1
3	10081-BK603	NAMEPLATE	PLAQUE D'IDENTIFICATION	1	1	1	1
4	10958-K70	TOP CASTING INSERT	PANNEAU DE COUVERCLE	1	1	1	1
5	10571-6	HEAT INDICATOR	INDICATEUR DE CHALEUR	1	1	1	1
6	10240-15	HINGE PIN	ATTACHE DE CHEVILLE	2	2	2	2
6A.	S21237	HINGE PIN SPACER	ESPACEUR DE CHEVILLE CHARNIÈRES	2	2	2	2
7	S21233	HITCH PIN CLIP	ATTACHE DE CHEVILLE	2	2	2	2
9	10225-T626	GRID - PORCELAIN	GRILLE EN PORCELAINE	3	3	3	3
10	10222-T626	FLAV-R-CAST	FLAV-R-CAST	2	2	2	2
11	10225-T628	GRID - WARMING RACK	GRILLE DE RÉCHAUD	1	1	1	1
12	10225-T627	SWING BASKET	PANIER À BALANCOIR	1	1	1	1
13	Y-11797	BOLT SWING BASKET	BOULON POUR PANIER A BALANCOIR	2	2	2	2
15	10390-T501	BURNER/VENTURI ASSY	ENSEMBLE DE BRÛLEUR	1	1	1	1
17	10342-245	ELECTRONIC IGNITOR	ALLUMAGE ÉLECTRONIQUE	1	1	•	•
	10342-246	ELECTRONIC IGNITOR	ALLUMAGE ÉLECTRONIQUE	•	•	1	1
18	10342-T301	ELECTRODE	ÉLECTRODE	2	2	2	2
21	10440-R64	CONTROL ASSY LP-3V	SOUPAPE, (GAZ PROPANE)	1	•	•	•
	10440-R65	CONTROL ASSY NG-3V	SOUPAPE, (GAZ NATUREL)	•	1	•	•
	10442-R66	CONTROL ASSY LP-4V	SOUPAPE, (GAZ PROPANE)	•	•	1	•
	10442-R67	CONTROL ASSY NG-4V	SOUPAPE, (GAZ NATUREL)	•	•	•	1
21A.	S13467-091	HOSE-SIDE BURNER LP	TUYAU DU BRÛLEUR LATÉRAL PL	•	•	1	•
	S13467-132	HOSE-SIDE BURNER NG	TUYAU DU BRÛLEUR LATÉRAL GN	•	•	•	1
	Y-11230	COTTER PIN	ATTACHE DE CHEVILLE	•	•	1	1
21B.	10110-91	TUBE-REAR BURNER ASSY	TUBE DE BRÛLEUR ARRIÈRE	1	1	1	1
22	10114-17	HOSE & REGULATOR LP - QCC1	TUYAU ET REGULATEUR PL - QCC1	1	•	1	•
	10111-K47	HOSE NATURAL GAS	TUYAU POUR GAZ NATUREL	•	1	•	1
22A.	10111-27	FLEX HOSE - SS	TUYAU DE CÂBLE - AI	1	1	1	1
23	10472-K37	CONTROL KNOB	BOUTON DE CONTROLE	3	3	4	4
24	10153-44	HOSE CONNECTOR	CONNECTEUR DE TUYAU	1	1	1	1
25	Y-12854	WASHER	RONDELLE	1	1	1	1
26	10153-47	ELBOW - 90 DEG.	COUDE 90 DEGRÉS	1	1	1	1
30a.	10081-BK613	NAMEPLATE	PLAQUE D'IDENTIFICATION	1	1	1	1
31	10194-R651	CONTROL COVER	PANNEAU DE CONTROLE	1	1	1	1
	10194-D77	CONTROL COVER	PANNEAU DE CONTROLE	1	1	•	•
	10194-D79	CONTROL COVER	PANNEAU DE CONTROLE	•	•	1	1
33	10184-R801	RADIATION SHIELD	ÉCRAN DE CHALEUR	1	1	1	1
35	10184-R641	SUPPORT-CASTING-LEFT	SUPPORT DU FOYER - GAUCHE	1	1	1	1
36	10184-R651	SUPPORT-CASTING-RIGHT	SUPPORT DU FOYER - DROIT	1	1	1	1
37	10184-R581	SUPPORT-SIDE SHELF-LEFT	SUPPORT TABLETTE DE GAUCHE	2	2	2	2
38	10184-R591	SUPPORT-SIDE SHELF-RIGHT	SUPPORT TABLETTE DE DROIT	2	2	2	2
39	10958-R831	BRACE-REAR	SUPPORT ARRIÈRE	1	1	1	1
40	10711-D501	BASE	TABLETTE INFÉRIEURE	1	•	1	•
	10711-D511	BASE	TABLETTE INFÉRIEURE	•	1	•	1
40A.	10184-D821	TANK RETAINER	SERVITEUR DU RESERVOIR	1	•	1	•
41	10958-K851	BRACE - FRONT	SUPPORT AVANT	1	1	1	1
42	10958-D89	DOOR - FRONT	PORTE DE L'AVANT	2	2	2	2
42A.	10958-D921	DOOR - INNER	PORTE INTÉRIEURE	2	2	2	2
43	10958-D861	SIDE PANEL BLK	PANNEAU LATÉRALE	2	2	2	2
44	10958-D901	REAR PANEL BLK	PANNEAU ARRIÈRE	1	1	1	1
45	10958-D961	DRAWER	TIROIR	1	1	1	1
46	10958-D841	BRACE - FRONT	SUPPORT AVANT	1	1	1	1
50	10711-K561	SHELF-SIDE-RIGHT	PLANCHETTE LATÉRALE - DROIT	1	1	1	1
51	10711-K562	SHELF-SIDE-LEFT	PLANCHETTE LATÉRALE - GAUCHE	1	1	•	•
	10711-K563	SHELF-SIDE-BURNER	PLANCHETTE - BRÛLEUR DE CÔTÉ	•	•	1	1
56	10892-8	WHEEL	ROUE	2	2	2	2
65	S13005	BURNER ROTISSERIE	BRÛLEUR DE TOURNEBROCHE	1	1	1	1
68	S21362	SPRING	RESSORT	1	1	1	1
70	Y-11990	HEX NUT	ÉCROU	1	1	1	1
71	10696-127	REARBURNER-ORIFICE LP	ORIFICE DU BRÛLEUR ARRIÈRE PL	1	•	1	•
	10696-185	REARBURNER-ORIFICE NG	ORIFICE DU BRÛLEUR ARRIÈRE GN	•	1	•	1
73	S21420	PUSH NUT	POUSSE ÉCROU	2	2	2	2
74	Y-6616	BOLT 1/4-20 X 1 1/2	BOULON - 1/4-20 X 1 1/2	2	2	2	2
75	10338-145	HANDLE	POIGNÉE	2	2	2	2
76	10239-6	WASHER-HANDLE	RONDELLE DE LA POIGNÉE	2	2	2	2

78	10892-22	CASTOR	ROULETTES	2	2	2	2
79	Y-11560	BOLT – 1/4:20 x 1 1/2	BOULON - 1/4:20 X 1 3/4	2	2	2	2
80	Y-11546	SCREW- 1/4-20 X 5/8	VIS – 1/4-20 X 5/8	8	8	8	8
81	Y-11545	SCREW – 1/4-20 X 1 3/8	VIS – 1/4-20 X 1 3/8	4	4	4	4
82A.	Y-12855	SCREW 1/4-20 X 3/8	VIS – 1/4-20 X 3/8	30	26	30	26
84	S15172	AXEL	ESSIEU	1	1	1	1
85	Y-12220	BUSHING	DOUILLE	1	1	1	1
86	Y-11795	LOCK NUT – 1/4-20	ÉCROU DE SERRURE – 1/4-20	8	8	8	8
87	Y-11793	NUT - 1/4-20	ÉCROU – 1/4-20	16	12	16	12
88	Y-11598	NUT-WING – 1/4-20	ÉCROU-PAPILLON – 1/4-20	2	2	2	2
97	Y-12642	SCREW – 8 X 1/2	VIS - 8 X 1/2	6	6	6	6
98	S21124	SCREW – 8 X 1/2	VIS - 8 X 1/2	18	18	18	18
104	Y-12835	SCREW – 6-32 X 1/4	VIS – 6-32 X 1/4	•	•	2	2
105	Y-29307	NUT – 10-24	ECROU – 10-24	•	•	4	4
108	PB20-60	LID HANDLE	POIGNÉE	•	•	1	1
109	S21136	SCREW – 8-32 X 3/8	VIS – 8-32 X 3/8	6	6	8	8
110	10225-T10	GRID	GRILLE	•	•	1	1
111	10390-E10	SIDE BURNER	BRÛLEUR DE CÔTÉ	•	•	1	1
113	10342-T14	ELECTRODE – SIDE BURNER	ÉLÉCTRODE – BRÛLEUR DE CÔTÉ	•	•	1	1
114	10393-K40	COVER-SIDE BURNER	COUVERCLE LATÉRAL	•	•	1	1
115	Y-29304S	SCREW – 10-24 X 3/8 SS	VIS – 10/24 X 3/8 AI	4	4	4	4
116	Y-29304	SCREW – 10-24 X 3/8	VIS – 10/24 X 3/8	•	•	4	4
117	10393-R50	SHELF-SIDE BURNER	SUPPORT DE BRÛLEUR DE CÔTÉ	•	•	1	1
121	10184-D611	BRACKET – CASTOR SUPPORT	SUPPORT DE ROULETTE	1	1	1	1
123	S15115	GREASE PAN - DISPOSABLE	CUVETTE À GRAISSE	2	2	2	2
127	10184-D801	BRACKET – MAGNET STOP	SUPPORT – ARRÊT AIMANT	1	1	1	1
128	Y-12118	1/2 HEYCO PLUG	PRISE DE 1/2 HEYCO	8	8	8	8
129	Y-9997	DRAWER SLIDE	GLISSIÈRE DE TIROIR	2	2	2	2
130	Y-12221	MAGNET	AIMANT	4	4	4	4
131	10184-D81	WIRE HINGE	CHARNIÈRE DE FIL	2	2	2	2
132	Y-12288	LOCK NUT – 3/8-16	ÉCROU DE SERRURE – 3/8-16	2	2	2	2
133	PB20-62	HANDLE – SS	POIGNÉE - AI	2	2	2	2
134	Y-12084	LOCK NUT – 8-32	ÉCROU DE SERRURE – 8-32	4	4	4	4
135	Y-12119	3/8 HEYCO BUSHING	DOUILLE DE 3/8 HEYCO	4	4	4	4



