

This Owner's Manual is provided and hosted by [Appliance Factory Parts](#).



COMFORT-AIRE HRG1460-1A Owner's Manual

[Shop genuine replacement parts for COMFORT-AIRE
HRG1460-1A](#)



[Find Your COMFORT-AIRE HVAC Parts - Select From 1486 Models](#)

----- Manual continues below -----

HRG14-1A

HEAT CONTROLLER, INC.

Parts List
15-February-2012



This parts list is current as of the above revision date.

Form Number: 92-42810-HRG14-1A

Table of Contents

Model Explanation	Page 3
Parts Numbers	
Panels - Miscellaneous	Page 4
Electrical-Fan Group	Page 5
Coil Parts	Page 5
Compressor Group	Page 6
Accessories	Page 7
Drawings/Photographs	
Exploded View	Page 8
Control Box Assembly	Page 9
Valve Mounting Detail	Page 10
Notes	Page 11

MODEL NUMBER EXPLANATION

H	R	G	1	4	1	8	-	1	A
1			2			3			

- (1) SERIES**
- (2) COOLING CAPACITY (BTU/HR)**
 - 18= 18,000
 - 24= 24,000
 - 30= 30,000
 - 36= 36,000
 - 42= 42,000
 - 48= 48,000
 - 60= 60,000
- (3) OPTIONS**

SERIAL NUMBER EXPLANATION

7	0	9	2	N	0	7	0	1	9	9	9	9	9
1				2	3		4		5				

- (1) COMPRESSOR IDENTIFICATION NUMBER**
- (2) PRODUCTION LOCATION**
- (3) WEEK OF PRODUCTION**
- (4) YEAR OF PRODUCTION**
- (5) PRODUCTION NUMBER**

No.	Notes	MODEL COOLING CAPACITY VARIATION	HRG14 18 1A	HRG14 24 1A	HRG14 30 1A	HRG14 36 1A
SHEET METAL PARTS, MISCELLANEOUS						
1		Cabinet	AE-100726-31	AE-100726-31	AE-100726-32	AE-100726-33
2		Cabinet Panel	AE-100727-31	AE-100727-31	AE-100727-32	AE-100727-33
3		Base Pan	AS-100058-01	AS-100058-01	AS-100058-02	AE-101588-03
4		Control Box	AE-100654-31	AE-100654-31	AE-100654-31	AE-100654-31
5		Control Box Cover	AE-100657-31	AE-100657-31	AE-100657-31	AE-100657-31
6		Top Panel	AE-100652-01	AE-100652-01	AE-100652-02	AE-100652-03
8		Grille	95-100906-01	95-100906-01	95-100906-03	95-100906-04
		Center Cap - Blank (for Grille)	91-101123-09	91-101123-09	91-101123-09	91-101123-09
12		Valve Mounting Panel	AE-57780-01	AE-57780-01	AE-57780-01	AE-57780-01
14		Service Valve - Suction	See Coil Group			
15		Service Valve - Liquid	See Coil Group			
17		Low Voltage Cover	AE-57756-01	AE-57756-01	AE-57756-01	AE-57756-01
		Touch-up Paint - Dark Gray (Aerosol)	523009	523009	523009	523009
		Touch-up Paint - Dark Gray (Paint Pens)	523011	523011	523011	523011
		Touch-up Paint - Light Gray (Aerosol)	523014	523014	523014	523014
		Touch-up Paint - Light Gray (Paint Pens)	523015	523015	523015	523015

No.	Notes	MODEL COOLING CAPACITY VARIATION	HRG14 42 1A	HRG14 48 1A	HRG14 60 1A
SHEET METAL PARTS, MISCELLANEOUS					
1		Cabinet	AE-100726-34	AE-100726-34	AE-100726-34
2		Cabinet Panel	AE-100727-34	AE-100727-34	AE-100727-34
3		Base Pan	AE-101588-03	AE-101588-03	AE-101588-03
4		Control Box	AE-100654-34	AE-100654-34	AE-100654-34
5		Control Box Cover	AE-100657-31	AE-100657-31	AE-100657-31
6		Top Panel	AE-100652-03	AE-100652-03	AE-100652-03
8		Grille	95-100906-04	95-100906-04	95-100906-04
		Center Cap - Blank (for Grille)	91-101123-09	91-101123-09	91-101123-09
12		Valve Mounting Panel	AE-100185-31	AE-100185-31	AE-100185-31
14		Service Valve - Suction	See Coil Group		
15		Service Valve - Liquid	See Coil Group		
17		Low Voltage Cover	AE-57756-01	AE-57756-01	AE-57756-01
		Touch-up Paint - Dark Gray (Aerosol)	523009	523009	523009
		Touch-up Paint - Dark Gray (Paint Pens)	523011	523011	523011
		Touch-up Paint - Light Gray (Aerosol)	523014	523014	523014
		Touch-up Paint - Light Gray (Paint Pens)	523015	523015	523015

No.	Notes	MODEL COOLING CAPACITY VARIATION	HRG14	HRG14	HRG14	HRG14
			18 1A	24 1A	30 1A	36 1A
ELECTRICAL/FAN GROUP						
7	Stk	Fan Motor	51-101774-04	51-101774-04	51-101774-02	51-101774-02
9	Stk	Fan Blade	70-102033-05	70-102033-05	70-102033-02	70-102011-04
16	Stk	Contactora	42-42478-03	42-42478-03	42-42478-03	42-42478-03
17		Low Voltage Cover	See Panels - Miscellaneous			
18		Control Box Bottom	AE-100655-01	AE-100655-01	AE-100655-01	AE-100655-01
19		Capacitor - Compressor/Fan	See Compressor Group			
20	Stk	Defrost Control Board	47-21517-16	47-21517-16	47-21517-16	47-21517-16
21		Low Ambient Control	See Accessories Group			

No.	Notes	MODEL COOLING CAPACITY VARIATION	HRG14	HRG14	HRG14	
			42 1A	48 1A	60 1A	
ELECTRICAL/FAN GROUP						
7	Stk	Fan Motor	51-102008-03	51-102008-03	51-102008-03	
9	Stk	Fan Blade	70-102011-04	70-102011-04	70-102011-04	
16	Stk	Contactora	42-42478-03	42-42478-03	42-42478-02	
17		Low Voltage Cover	See Panels - Miscellaneous			
18		Control Box Bottom	AE-100655-01	AE-100655-01	AE-100655-01	
19		Capacitor - Compressor/Fan	See Compressor Group			
20	Stk	Defrost Control Board	47-21517-16	47-21517-16	47-21517-16	
21		Low Ambient Control	See Accessories Group			

No.	Notes	MODEL COOLING CAPACITY VARIATION	HRG14	HRG14	HRG14	HRG14
			18 1A	24 1A	30 1A	36 1A
COIL GROUP						
11	Stk	Condenser Coil	AS-101766-03	AS-101766-03	AS-102391-03	AS-101768-03
13		Valve Mounting Bracket	AE-57781-01	AE-57781-01	AE-57781-01	AE-57781-02
14		Service Valve - Suction	61-21368-23	61-21368-23	61-21368-07	61-21368-22
15		Service Valve - Liquid	61-21368-05	61-21368-05	61-21368-05	61-21368-05
22		Bulkhead Valve	61-22369-04	61-22369-04	61-22369-04	61-22369-04
		Locknut - Bulkhead Valve	63-22368-01	63-22368-01	63-22368-01	63-22368-01
	Stk	Filter Drier	83-41719-04	83-41719-04	83-41719-04	83-41719-04
		TXV/Distributor Assembly	61-102437-01	61-102437-02	61-102437-03	61-102437-03
	Stk	Reversing Valve	61-102498-04	61-102498-04	61-101684-02	61-101684-02
	Stk	Solenoid Coil - Reversing Valve	61-101713-03	61-101713-01	61-101713-01	61-101713-01
		Wiring Harness - Reversing Valve	61-26149-03	61-26149-03	61-26149-03	61-26149-03

No.	Notes	MODEL COOLING CAPACITY VARIATION	HRG14	HRG14	HRG14	
			42 1A	48 1A	60 1A	
COIL GROUP						
11	Stk	Condenser Coil	AS-101760-03	AS-102099-03	AS-101771-01	
13		Valve Mounting Bracket	AE-57781-02	AE-57781-02	AE-57781-02	
14		Service Valve - Suction	61-21368-22	61-21368-08	61-21368-08	
15		Service Valve - Liquid	61-21368-05	61-21368-05	61-21368-05	
22		Bulkhead Valve	61-22369-04	61-22369-04	61-22369-04	
		Locknut - Bulkhead Valve	63-22368-01	63-22368-01	63-22368-01	
	Stk	Filter Drier	83-41719-04	83-41719-04	83-41719-04	
		TXV/Distributor Assembly	61-102437-05	61-102437-06	61-102437-08	
	Stk,2	Reversing Valve - See Note 2	61-101684-02	61-101684-06	61-101684-03	
	Stk	Solenoid Coil - Reversing Valve	61-101713-01	61-101713-01	61-101713-01	
		Wiring Harness - Reversing Valve	61-26149-03	61-26149-03	61-26149-03	

No.	Notes	MODEL COOLING CAPACITY VARIATION	HRG14 18 1A	HRG14 24 1A	HRG14 30 1A	HRG14 36 1A
COMPRESSOR GROUP						
IMPORTANT NOTE: Replacement Compressors MUST be selected using the Compressor ID from the unit's Serial Number. Do not interchange compressors from other Compressor ID's used on the model.						
		Compressor ID:	7782	7776	7777	7779
10	Stk	Compressor	55-102045-14S	55-102045-01S	55-102045-02S	55-102045-03S
19	Stk	Capacitor - Compressor/Fan	43-26261-40	43-26261-09	43-26261-09	43-26261-48
		Muffler	83-26251-01	83-26251-01	83-26251-01	83-26251-01
	Stk	Compressor Wiring Harness (Molded Plug)	45-100834-80	45-100834-80	45-100834-80	45-100834-80
		Compressor ID:			7778	7780
10	1	Original Compressor - See Note 1			55-101545-44S	55-102282-07S
10	Stk,1	Replacement Compressor (Retrofit Kit Required) - See Note 1			55-102045-02S	55-102045-03S
	Stk,1	Retrofit Kit - See Note 1			831019	831020
19	Stk	Capacitor - Compressor/Fan			43-26261-44	43-26261-48
		Muffler/Check Valve			83-101828-01	N/A
		Muffler			N/A	83-26251-01

No.	Notes	MODEL COOLING CAPACITY VARIATION	HRG14 42 1A	HRG14 48 1A	HRG14 60 1A	
COMPRESSOR GROUP						
IMPORTANT NOTE: Replacement Compressors MUST be selected using the Compressor ID from the unit's Serial Number. Do not interchange compressors from other Compressor ID's used on the model.						
		Compressor ID:	7781	7783	7784	
10	Stk	Compressor	55-102045-12S	55-102045-09S	55-102045-26S	
19	Stk	Capacitor - Compressor/Fan	43-26261-42	43-26261-47	43-26271-47	
	Stk	Compressor Wiring Harness (Molded Plug)	45-100834-80	45-100834-80	45-100834-80	
		Crankcase Heater	N/A	N/A	44-101884-05	
		Muffler	83-26251-01	83-26251-01	83-26251-01	
		Compressor ID:			7826	
10	1	Original Compressor - See Note 1			55-102282-01S	
10	Stk,1	Replacement Compressor (Retrofit Kit Required) - See Note 1			55-102045-26S	
	Stk,1	Retrofit Kit - See Note 1			831022	
19	Stk	Capacitor - Compressor/Fan			43-26261-47	
		Muffler			83-26251-01	

No.	Notes	MODEL COOLING CAPACITY VARIATION	HRG14 ALL ALL
ACCESSORIES			
		Low Ambient Control	RXAD-A08
		Outdoor Thermostat (One Thermostat w/box)	RXPT-A01
		Outdoor Thermostat (One Thermostat w/o box)	RXPT-A02
		Outdoor Thermostat (One w/Heat Relay and box)	RXPT-A03
		Outdoor Thermostat (Two Thermostats w/Heat and box)	RXPT-A04
		Heat Pump Monitor	RXPM-B01
		Compressor Time Delay Control	RXMD-B01
		Blower Time Delay Control	RXMD-C04
		High Pressure Control	RXAB-A07

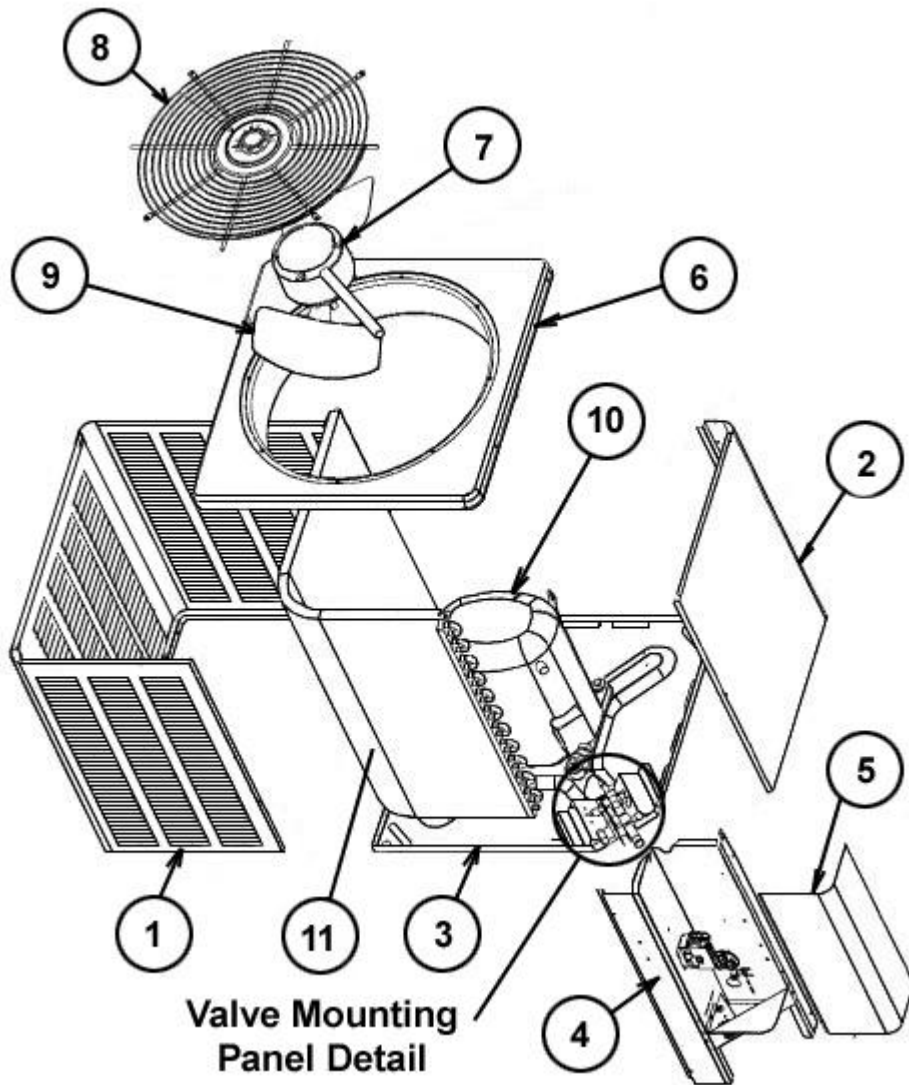

Exploded View

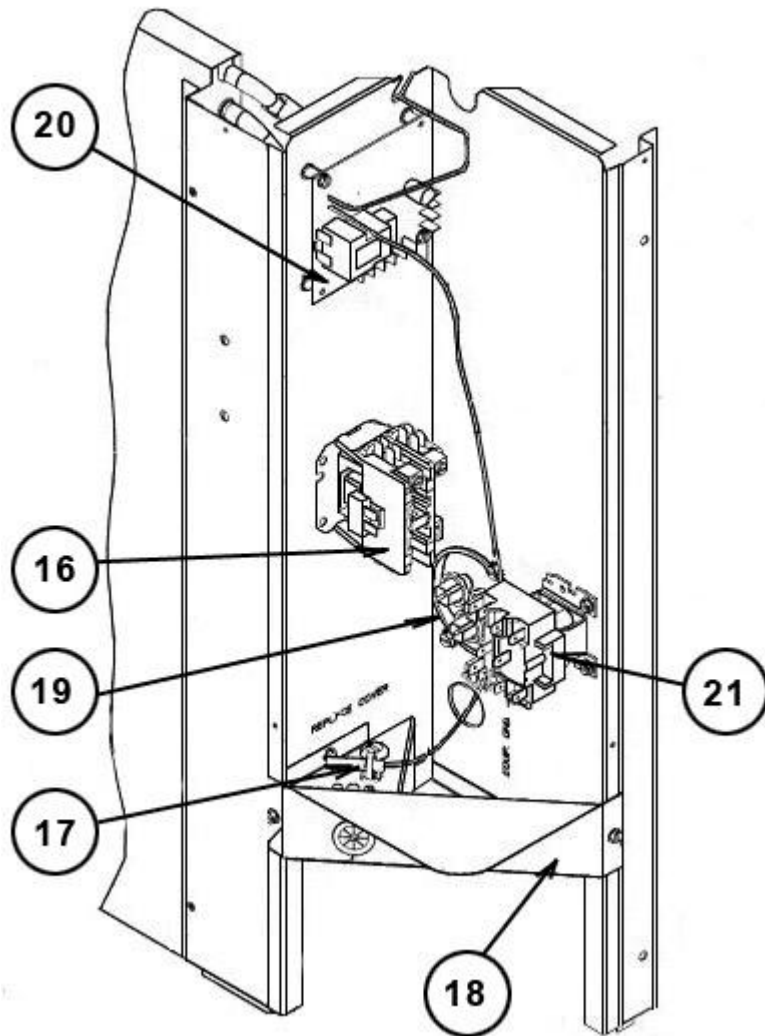

Control Box Assembly

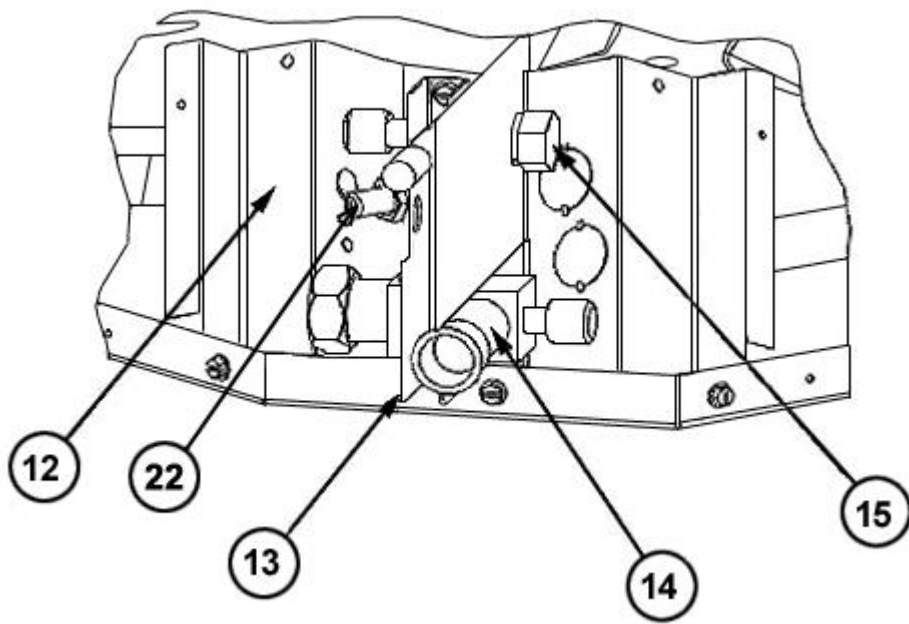

Valve Mounting Detail

NOTES

Stk It is recommended that stock be maintained for this part.

N/A Not Applicable

- 1 This compressor should be replaced with the designated Copleland scroll (55-102045 series) and the specified Retrofit Kit. **USE OF THE RETROFIT KIT IS REQUIRED WHEN PERFORMING THIS REPLACEMENT.** Failure to use the kit will greatly increase the likelihood of future compressor failure and will void the compressor warranty.
- 2 The reversing valve specified for 048 models may be different than the one originally supplied with the equipment. The use of the specified valve is recommended for improved shifting performance.