

This Owner's Manual is provided and hosted by [Appliance Factory Parts](#).

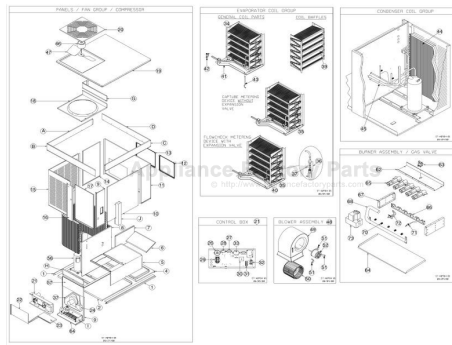

# COMFORT-AIRE RKA-A036C Owner's Manual

[Shop genuine replacement parts for COMFORT-AIRE  
RKA-A036C](#)



[Find Your COMFORT-AIRE HVAC Parts - Select From 1486 Models](#)

----- Manual continues below -----

# **[ - ]RKA / [ - ]RMA**

**Parts List**

## **Gas / Electric Package Units**

Series A

Sizes 018-060



Field Test 10/93, 03/94 ps

Full Production 05/95 ps

This Revision August 2001 ls/ps

Supersedes Form Number 92-21389-76-00

Form Number 92-21389-76-01

**CATALOG TAB - PACKAGE UNITS**

## TABLE OF CONTENTS

Notes	Page 2
Model Number Explanation	Page 3
Serial Number Explanation	Page 3
Exploded View	Page 4
Panels & Miscellaneous Parts	Page 5
Fan - Blower Group	Page 6
Electrical Group	Page 7
Evaporator - Condenser Coil	Page 8
Compressor Group	Page 9-10
Heat Exchanger - Burner Assembly	Page 11
Gas Controls	Page 12

## ORDERING, STOCKING AND NOTE EXPLANATIONS

### Ordering Instructions:

When ordering a replacement part, be sure to read all notes and symbol notations on the parts list. In some cases, it is necessary to determine the unit style number and/or serial number in addition to the model number before selecting a replacement part. When ordering painted cabinet parts, the order **must specify** unit model number, serial number, and paint color. Also, your order can be processed more rapidly if you show the part number and description. Once the product is out of current production, ordering such parts must be cleared with the Parts Department as price and availability will vary.

### Replacement Parts Stocking Information:

See the current "List Price Book For Air Conditioning Parts" for individual stock code information. As a general rule, most parts are in stock or have a short order period as long as the product is in current production. Once the product is out of current production, ordering such parts must be cleared with the Parts Department as price and availability will vary.

### Note Explanation:

<i>np</i>	This part is not shown in exploded view. [no picture]
<i>cr</i>	This original part number has been <b>cross-referenced</b> to an equal, or better than replacement, part number.
<i>dna</i>	<b>Does not apply</b>
<i>fi</i>	<b>Finished Good Accy</b> and must order thru the National Order Center
<i>nw</i>	This part was <b>new</b> to the List Price Book when the product was introduced
<i>stk</i>	This part should be <b>stocked</b> .
<i>()</i>	Order quantity

## MODEL NUMBER EXPLANATION

[ ] R K A - A 036     J     K 10 E  
 (1) (2) (3) (4)     (5) (6)     (7)     (8) (9) (10)

### Position

- (1) Tradename Identification
- (2) R = Rooftop
- (3) Efficiency Designation  
     K = 10 SEER  
     M = 12 SEER
- (4) Design Series
- (5) Technical Variations
- (6) Cooling Capacity (BTUH)  
     018 = 18,000  
     024 = 24,000  
     030 = 30,000  
     036 = 36,000  
     042 = 42,000  
     048 = 48,000  
     060 = 60,000

### Position

- (7) Electrical Designation  
     J = 208-230/1/60
- (8) Drive Package  
     K = Direct Drive
- (9) Heating Capacity - (MBH)  
     04 = 40,000  
     06 = 60,000  
     08 = 80,000  
     10 = 100,000
- (10) Ignition System  
     E = Electric  
     X = Electric Nox

## SERIAL NUMBER EXPLANATION

1X A     1234     A     A     A     A     F2695     0001  
 (1) (2)     (3)     (4)     (5) (6) (7)     (8)     (9)

- (1) **GAS VALVE & IGNITION CONTROL COMBINATION:**  
     [1A] HONEYWELL SNAP OPEN (VR8205) & UNITED TECHNOLOGIES DIRECT SPARK (1016-452)  
     [1C] HONEYWELL SNAP OPEN (VR8205) & JOHNSON CONTROLS DIRECT SPARK (G766BCA)  
     [1D] WHITE-RODGERS SNAP OPEN (36E36) & UNITED TECHNOLOGIES DIRECT SPARK (1016-452)  
     [1E] WHITE-RODGERS SNAP OPEN (36E36) & JOHNSON CONTROLS DIRECT SPARK (G766BCA)  
     [1R] HONEYWELL SNAP OPEN (VR8205) & UNITED TECHNOLOGIES DIRECT SPARK (1068-300)  
     [1S] WHITE-RODGERS SNAP OPEN (36E36) & UNITED TECHNOLOGIES DIRECT SPARK (1068-300)
- (2) **BLOWER CONTROL BOARD:**  
     [D] ROBERTSHAW (100-833-01)
- (3) **COMPRESSOR IDENTIFICATION NUMBER:**
- (4) **IGNITION DEVICE:**  
     [A] PRECISION SPEED EQUIPMENT (PSE-RH6)
- (5) **INDUCER BLOWER:**  
     [A] AMETEK PLASTIC HOUSING  
     [B] EMERSON PLASTIC HOUSING  
     [C] EMERSON METAL HOUSING  
     [D] FASCO METAL HOUSING
- (6) **HEAT EXCHANGER:**  
     [A] T140 ALUMINIZED STEEL TUBULAR 1.750 O.D.
- (7) **TECHNOLOGY VARIATIONS:**  
     [A] INITIAL DESIGN
- (8) **PRODUCTION LOCATION & DATE CODE:**  
     [F] FORT SMITH, AR  
     Date Code = Week and Year
- (9) **PRODUCTION NUMBER:**  
     STARTS WITH 0001 & RUNS THROUGH 9999 & THEN STARTS WITH 0001 AGAIN.

PANELS / FAN GROUP / COMPRESSOR

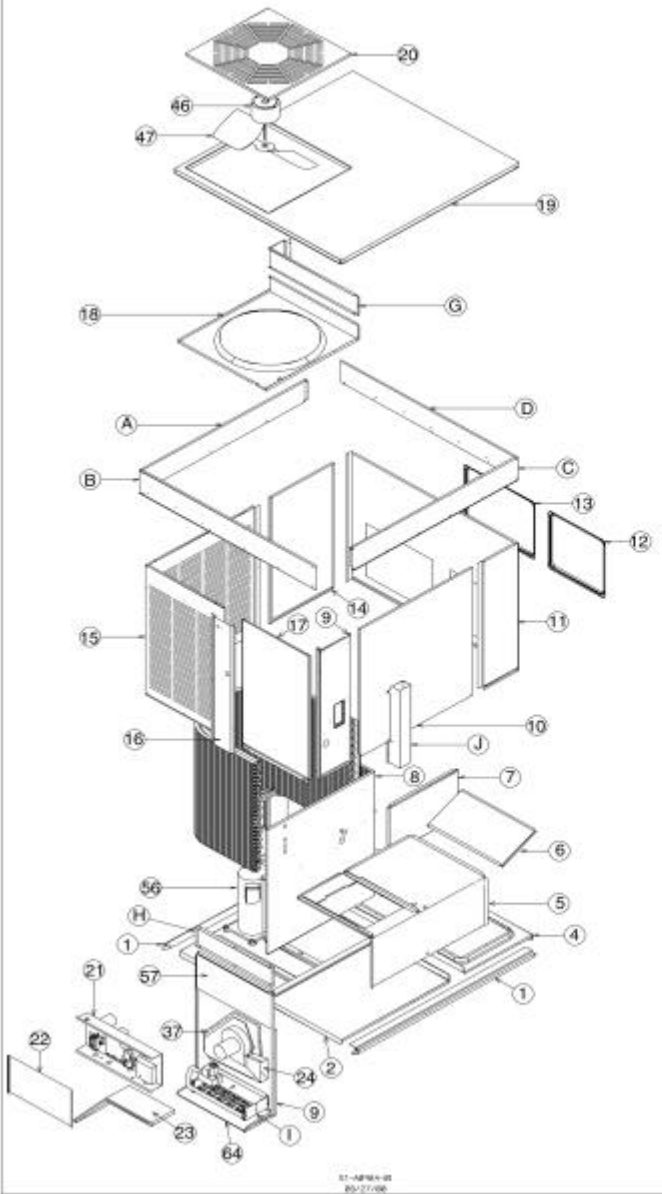

ST-APR-03  
80-27-00

EVAPORATOR COIL GROUP

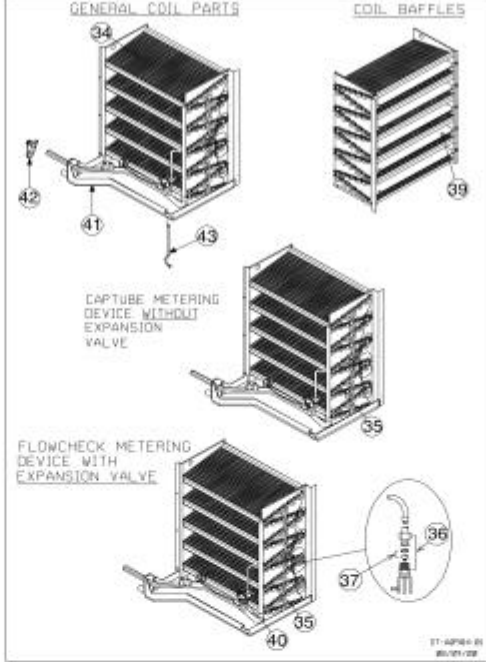

ST-APR-03  
80-27-00

CONTROL BOX 21

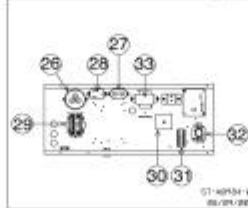

ST-APR-03  
80-27-00

BLOWER ASSEMBLY 48

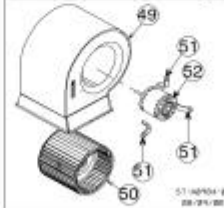

ST-APR-03  
80-27-00

CONDENSER

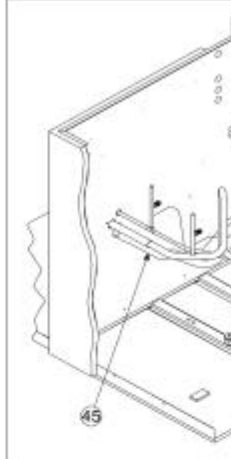

BURNER ASSEMBLY

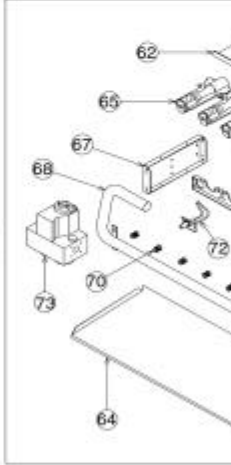

No.	MODEL	Note	[RKA- RMA- A 018	[RKA- RMA- A 024	[RKA- RMA- A 030	[RKA- RMA- A 036	[RKA- RMA- A 042	[RKA- RMA- A 048	[RKA- RMA- A 060	
TECHNICAL VARIATION COOLING CAPACITY										
PANELS AND MISCELLANEOUS PARTS										
1	BASE RAIL (2)		AE-58562-02	AE-58562-02	AE-58562-02	AE-58562-02	AE-58562-02	AE-58562-02	AE-58562-02	
2	FRONT BASE PAN		AS-58628-01	AS-58628-01	AS-58628-01	AS-58628-01	AS-58628-01	AS-58628-01	AS-58628-01	
np	HEAT EXCHANGER TUBE SUPPORT		AE-58590-01	AE-58590-01	AE-58590-01	AE-58590-01	AE-58590-01	AE-58590-01	AE-58590-01	
4	BACK BASE PAN		AS-58607-10	AS-58607-10	AS-58607-10	AS-58607-10	AS-58607-10	AS-58607-10	AS-58607-10	
5	BLOWER SHELF		AS-58630-01	AS-58630-01	AS-58630-01	AS-58630-01	AS-58630-01	AS-58630-01	AS-58630-01	
6	BLOWER SHELF TRANSITION		AS-58607-19	AS-58607-19	AS-58607-19	AS-58607-19	AS-58607-19	AS-58607-19	AS-58607-19	
7	DIVIDER PANEL		AS-58607-03	AS-58607-03	AS-58607-03	AS-58607-03	AS-58607-03	AS-58607-03	AS-58607-03	
8	BULKHEAD ASSEMBLY		AS-58607-01	AS-58607-01	AS-58607-01	AS-58607-01	AS-58607-01	AS-58607-01	AS-58607-01	
9	CORNER POST		AS-58607-40	AS-58607-40	AS-58607-40	AS-58607-40	AS-58607-40	AS-58607-40	AS-58607-40	
10	BLOWER ACCESS PANEL		AS-58607-09	AS-58607-09	AS-58607-09	AS-58607-09	AS-58607-09	AS-58607-09	AS-58607-09	
11	END PANEL		AS-58607-04	AS-58607-04	AS-58607-04	AS-58607-04	AS-58607-04	AS-58607-04	AS-58607-04	
	SUPPLY COVER:									
12	Pictured		AS-58607-06	AS-58607-06	AS-58607-06	AS-58607-06	AS-58607-06	AS-58607-06	AS-58607-06	
np	Side Option		AS-58607-35	AS-58607-35	AS-58607-35	AS-58607-35	AS-58607-35	AS-58607-35	AS-58607-35	
	RETURN COVER:									
13	Pictured		AS-58607-05	AS-58607-05	AS-58607-05	AS-58607-05	AS-58607-05	AS-58607-05	AS-58607-05	
np	Side Option		AS-58607-34	AS-58607-34	AS-58607-34	AS-58607-34	AS-58607-34	AS-58607-34	AS-58607-34	
14	FILTER ACCESS PANEL		AS-58607-08	AS-58607-08	AS-58607-08	AS-58607-08	AS-58607-08	AS-58607-08	AS-58607-08	
15	CONDENSER LOUVER PANEL		AS-58607-37	AS-58607-37	AS-58607-37	AS-58607-38	AS-58607-38	AS-58607-38	AS-58607-38	
16	CENTER POST		AE-58569-01	AE-58569-01	AE-58569-01	AE-58569-01	AE-58569-01	AE-58569-01	AE-58569-01	
17	CONTROL ACCESS PANEL		AS-58607-20	AS-58607-20	AS-58607-20	AS-58607-20	AS-58607-20	AS-58607-20	AS-58607-20	
A	PANEL EXTENSION (Cond)		dna	dna	dna	dna	dna	dna	AS-58607-43	
B	PANEL EXTENSION		dna	dna	dna	dna	dna	dna	AS-59437-03	
C	PANEL EXTENSION (Blower)		dna	dna	dna	dna	dna	dna	AS-58607-44	
D	PANEL EXTENSION (Duct Opening)		dna	dna	dna	dna	dna	dna	AS-58607-45	
G	VENTURI EXTENSION		dna	dna	dna	dna	dna	dna	AE-59432-01	
18	VENTURI		AE-58585-01	AE-58585-01	AE-58585-01	AE-58585-01	AE-58585-01	AE-58585-01	AE-58585-01	
19	TOP PANEL		AS-58607-07	AS-58607-07	AS-58607-07	AS-58607-07	AS-58607-07	AS-58607-07	AS-58607-07	
20	GRILLE		AS-58634-01	AS-58634-01	AS-58634-01	AS-58634-01	AS-58634-01	AS-58634-01	AS-58634-01	
21	CONTROL BOX - Less Components		AE-58597-01	AE-58597-01	AE-58597-01	AE-58597-01	AE-58597-01	AE-58597-01	AE-58597-01	
22	CONTROL BOX COVER		AE-58598-01	AE-58598-01	AE-58598-01	AE-58598-01	AE-58598-01	AE-58598-01	AE-58598-01	
23	FURNACE SHELF		AS-58607-11	AS-58607-11	AS-58607-11	AS-58607-11	AS-58607-11	AS-58607-11	AS-58607-11	
24	EXHAUST HOOD		AS-58629-01	AS-58629-01	AS-58629-01	AS-58629-01	AS-58629-01	AS-58629-01	AS-58629-01	
J	COMBUSTION AIR INLET HOOD		AE-58599-01	AE-58599-01	AE-58599-01	AE-58599-01	AE-58599-01	AE-58599-01	AE-58599-01	
np	EXHAUST TRANSITION		AS-58607-36	AS-58607-36	AS-58607-36	AS-58607-36	AS-58607-36	AS-58607-36	AS-58607-36	
H	HEAT EXCHANGER EXTENSION		dna	dna	dna	dna	dna	dna	AE-59433-01	
51	EVAPORATOR COIL DRAIN PAN		See the Evaporator Coil Group on Page 8 for Drain Pan and Grommet Part Number							

No.	MODEL	Note	[-]RKA- [-]RMA- A 018 J	[-]RKA- [-]RMA- A 024 J	[-]RKA- [-]RMA- A 030 J	[-]RKA- [-]RMA- A 036 J / C	[-]RKA- [-]RMA- A 042 J / C	[-]RKA- [-]RMA- A 048 J / C	[-]RKA- A 060 J / C	
<b>FAN GROUP</b>										
46	Motor:	cr	51-23055-11 1/5 HP, 208-230 Volt, 1 Speed	51-23055-11 1/5 HP, 208-230 Volt, 1 Speed	51-23055-11 1/5 HP, 208-230 Volt, 1 Speed	51-23055-11 1/5 HP, 208-230 Volt, 1 Speed	51-23055-11 1/5 HP, 208-230 Volt, 1 Speed	51-23053-11 1/3 HP, 208-230 Volt, 1 Speed	51-21853-21 1/3 HP, 208-230 Volt, 1 Speed	
29	Run Capacitor		SEE COMPRESSOR GROUP FOR <b>DUAL</b> CAPACITOR PART NUMBER							
47	Fan Blade:	stk	70-20607-05 20", 16" Pitch, CCW	70-20607-05 20", 16" Pitch, CCW	70-21848-05 20", 26" Pitch, CCW	70-21848-05 20", 26" Pitch, CCW	70-21848-05 20", 26" Pitch, CCW	70-21848-07 20", 28" Pitch, CCW	70-21848-07 20", 28" Pitch, CCW	

No.	MODEL	Note	[-]RKA- [-]RMA- A 018	[-]RKA- [-]RMA- A 024	[-]RKA- [-]RMA- A 030	[-]RKA- [-]RMA- A 036	[-]RKA- [-]RMA- A 042	[-]RKA- [-]RMA- A 048	[-]RKA- A 060
<b>BLOWER GROUP</b>									
48	<b>BLOWER ASSEMBLY:</b>		AS-58662-01	AS-58662-01	AS-58662-02	AS-58662-02	AS-58662-02	AS-58662-06	AS-58662-06
49	Housing		AS-58619-01	AS-58619-01	AS-58619-02	AS-58619-02	AS-58619-02	AS-58619-02	AS-58619-02
np	Cut-Off		AE-64401-10	AE-64401-10	AE-64401-06	AE-64401-06	AE-64401-06	AE-64401-06	AE-64401-06
50	Blower Wheel:	cr	70-18631-01 9" x 7" 1/2" Bore CW	70-18631-01 9" x 7" 1/2" Bore CW	70-18625-01 10" x 9" 1/2" Bore CW	70-18625-01 10" x 9" 1/2" Bore CW	70-18625-01 10" x 9" 1/2" Bore CW	70-18625-01 10" x 9" 1/2" Bore CW	70-18625-01 10" x 9" 1/2" Bore CW
51	Motor Mounting Bracket		AS-53148-03	AS-53148-03	AS-53148-03	AS-53148-03	AS-53148-03	AS-53148-04	AS-53148-04
52	Motor:	cr	51-23024-31 1/4 HP, 208-230 Volt, 3 Speed	51-23024-31 1/4 HP, 208-230 Volt, 3 Speed	51-23022-41 1/2 HP, 208-230 Volt, 4 Speed	51-23022-41 1/2 HP, 208-230 Volt, 4 Speed	51-23022-41 1/2 HP, 208-230 Volt, 4 Speed	51-23650-01 3/4 HP, 208-230 Volt, 3 Speed	51-23650-01 3/4 HP, 208-230 Volt, 3 Speed
30	Capacitor:	stk	43-20847-04 5/370 MFD/Volts	43-20847-04 5/370 MFD/Volts	43-20847-12 10/370 MFD/Volts	43-20847-12 10/370 MFD/Volts	43-20847-12 10/370 MFD/Volts	43-20847-45 10/440 MFD/Volts	43-20847-45 10/440 MFD/Volts

No.	MODEL	Note	[-]RKA- [-]RMA- A 018/024	[-]RKA- [-]RMA- A 030/036	[-]RKA- [-]RMA- A 042/048	[-]RKA- A 060		
<b>ELECTRICAL GROUP</b>								
	CONTROL BOX COMPONENTS:							
	Run Capacitors:							
29	Compressor/Fan Motor-Round		See Compressor Group on Page 9 for the <i>Dual</i> Capacitor Part Number					
	Blower Motor - Oval		See Blower Assembly Group on this page for Part Number					
31	Transformer	cr	46-25107-03	46-25107-03	46-25107-03	46-25107-03		
32	Compressor Time Delay Control	stk	42-22756-02	42-22756-02	42-22756-02	42-22756-02		
33	Contactora	cr	42-25101-01	42-25101-01	42-25101-01	42-25101-01		
34	Blower Control Board - 100-833-01 Robertshaw	stk	47-23619-02	47-23619-02	47-23619-02	47-23619-02		
35	Pressure Switch	nw	42-23564-03	42-23564-03	42-23564-03	42-23564-03		
36	Ignition Control:							
	1016-452 United Technologies	stk	62-23554-02	62-23554-02	62-23554-02	62-23554-02		
	G766BCA Johnson Controls	nw	62-23584-01	62-23584-01	62-23584-01	62-23584-01		
61	LIMIT CONTROL (On Blower Shelf)		See the Heat Exchanger/Collector Box/Burner Assembly Group on Page 10					
63	OVERTEMPERATURE SWITCH		for these Part Numbers					
37	(IDB) MOTOR	nw	70-23641-01	70-23641-01	70-23641-01	70-23641-01		
np	IDB MOTOR GASKET	nw	68-23643-01	68-23643-01	68-23643-01	68-23643-01		



No.	MODEL TECHNICAL VARIATION COOLING CAPACITY	Note	[J]RKA- A 018	[J]RKA- A 024	[J]RKA- A 030	[J]RKA- A 036	[J]RKA- A 042	[J]RKA- A 048	[J]RKA- A 060
<b>EVAPORATOR COIL CONDENSER COIL, AND REFRIGERATION GROUP</b>									
34	EVAPORATOR COIL		AS-58627-71	AS-58627-91	AS-58627-52	AS-58627-62	AS-58627-43	AS-58627-83	AS-58627-05
	FLOWCHECK METERING:								
36	Distributor Without Piston		dna	dna	dna	dna	dna	61-23413-08	61-23413-10
37	Flowcheck Piston Kit		dna	dna	dna	dna	dna	61-25414-15	61-25414-17
35	Cap Tube Assembly		AS-21821-43	AS-21821-44	AS-21821-03	AS-21821-29	AS-21821-15	dna	dna
40	EXPANSION VALVE	nw	dna	dna	dna	dna	dna	61-21922-50	61-21922-51
41	DRAIN PAN		AS-58607-32	AS-58607-32	AS-58607-32	AS-58607-32	AS-58607-32	AS-58607-32	AS-58607-32
42	DRAIN PAN GROMMET	nw	56-23601-01	56-23601-01	56-23601-01	56-23601-01	56-23601-01	56-23601-01	56-23601-01
43	AUXILIARY DRAIN PIPE		AE-58611-01	AE-58611-01	AE-58611-01	AE-58611-01	AE-58611-01	AE-58611-01	AE-58611-01
44	CONDENSER COIL		AS-58677-02	AS-58677-02	AS-58677-03	AS-58677-04	AS-58677-05	AS-58677-05	AS-58677-01
	DRAIN TRAP - (attach to Drain Pan)	nw	68-23603-01	68-23603-01	68-23603-01	68-23603-01	68-23603-01	68-23603-01	68-23603-01
No.	MODEL TECHNICAL VARIATION COOLING CAPACITY	Note	[J]RMA- A 018	[J]RMA- A 024	[J]RMA- A 030	[J]RMA- A 036	[J]RMA- A 042	[J]RMA- A 048	
<b>EVAPORATOR COIL CONDENSER COIL, AND REFRIGERATION GROUP</b>									
34	EVAPORATOR COIL		AS-58627-82	AS-58627-82	AS-58627-83	AS-58627-83	AS-58627-94	AS-58627-83	
	FLOWCHECK METERING:								
36	Distributor Without Piston		61-23413-06	61-23413-06	61-23413-08	61-23413-08	AS-59031-04	61-23413-08	
37	Flowcheck Piston Kit		61-25414-09	61-25414-12	61-25414-14	61-25414-14	dna	61-25414-15	
	EVAP. COIL AIR BAFFLE (4)		dna	dna	dna	dna	AE-58631-01	dna	
40	EXPANSION VALVE	nw	61-21922-52	61-21922-35	61-21922-53	61-21922-54	61-21922-54	61-21922-50	
41	DRAIN PAN		AS-58607-32	AS-58607-32	AS-58607-32	AS-58607-32	AS-58607-32	AS-58607-32	
42	DRAIN PAN GROMMET	nw	56-23601-01	56-23601-01	56-23601-01	56-23601-01	56-23601-01	56-23601-01	
43	AUXILIARY DRAIN PIPE		AE-58611-01	AE-58611-01	AE-58611-01	AE-58611-01	AE-58611-01	AE-58611-01	
44	CONDENSER COIL		AS-58677-06	AS-58677-06	AS-58677-05	AS-58677-07	AS-58677-01	AS-58677-05	
	DRAIN TRAP - (attach to Drain Pan)	nw	68-23603-01	68-23603-01	68-23603-01	68-23603-01	68-23603-01	68-23603-01	

**COMPRESSOR GROUP**

THE ORIGINAL COMPRESSORS LISTED ARE THE PRIMARY PARTS USED ON THESE UNITS. OTHER COMPRESSORS MAY SOMETIMES BE USED. THE REPLACEMENT COMPRESSORS LISTED BELOW SHOULD BE USED TO REPLACE THE ORIGINAL COMPRESSORS. IF YOUR UNIT HAS A DIFFERENT COMPRESSOR, REFER TO YOUR "COMPRESSOR STANDARIZATION MANUAL" AND "COMPRESSOR ID SHEETS".

No.	MODEL TECHNICAL VARIATION COOLING CAPACITY.	Note	[-]RKA-A 018 J	[-]RKA-A 024 J	[-]RKA-A 030 J	[-]RKA-A 036 J	[-]RKA-A 042 J	[-]RKA-A 048 J	[-]RKA-A 060 J
<b>ORIGINAL AND REPLACEMENT COMPRESSOR - READ NOTE ABOVE</b>									
56	COMPRESSOR:								
	<i>Original Compressor ID Code</i>		<b>6228</b>	<b>6301</b>	<b>5538</b>	<b>5539</b>	<b>5540</b>	<b>6020</b>	<b>6670</b>
	Original Compressor		55-23140-03	55-23140-10	55-23139-50	55-23139-62	55-23139-41	55-23140-50	55-23140-46
	Replacement Compressor		55-23139-03s	55-23139-10s	55-23139-50s	55-23139-62s	55-23139-41s	55-23139-37s	55-23139-33s
29	DUAL RUN CAPACITOR-ROUND								
	<i>For Original Compressor</i>		43-23204-03 30/3/370 MFD/Volts	43-23204-28 30/3/440 MFD/Volts	43-23204-34 45/3/370 MFD/Volts	43-23204-32 55/3/370 MFD/Volts	43-23204-31 60/3/370 MFD/Volts	43-23204-13 45/5/440 MFD/Volts	43-23204-43 70/5/370 MFD/Volts
	<i>For Replacement Compressor</i>		43-23204-03 30/3/370 MFD/Volts	43-23204-28 30/3/440 MFD/Volts	43-23204-34 45/3/370 MFD/Volts	43-23204-32 55/3/370 MFD/Volts	43-23204-31 60/3/370 MFD/Volts	43-23204-13 45/5/440 MFD/Volts	43-23204-43 70/5/370 MFD/Volts
np	START KIT ACCESSORY	stk	SK-A1-1	SK-A1-1	SK-A1-1	SK-A1-1	SK-A1-1	SK-A4-1	data n/avail
	Start Relay	stk	42-18282-09	42-18282-09	42-18282-09	42-18282-09	42-18282-09	42-18282-09	data n/avail
	Start Capacitor	stk	43-17075-04	43-17075-04	43-17075-04	43-17075-04	43-17075-04	43-17075-07	data n/avail

No.	MODEL TECHNICAL VARIATION COOLING CAPACITY.	Note	[-]RKA-A 036 C	[-]RKA-A 042 C	[-]RKA-A 048 C	[-]RKA-A 060 C			
<b>ORIGINAL AND REPLACEMENT COMPRESSOR - READ NOTE ABOVE</b>									
56	COMPRESSOR:								
	<i>Original Compressor ID Code</i>		<b>5813</b>	<b>5814</b>	<b>6021</b>	<b>6671</b>			
	Original Compressor		55-23139-63	55-23139-71	55-23140-51	55-23140-47			
	Replacement Compressor		55-23139-63s	55-23139-71s	55-23139-38s	55-23139-34s			
29	DUAL RUN CAPACITOR-ROUND		dna	dna	dna	dna			
np	START KIT ACCESSORY		dna	dna	dna	dna			

**COMPRESSOR GROUP**

THE ORIGINAL COMPRESSORS LISTED ARE THE PRIMARY PARTS USED ON THESE UNITS. OTHER COMPRESSORS MAY SOMETIMES BE USED. THE REPLACEMENT COMPRESSORS LISTED BELOW SHOULD BE USED TO REPLACE THE ORIGINAL COMPRESSORS. IF YOUR UNIT HAS A DIFFERENT COMPRESSOR, REFER TO YOUR "COMPRESSOR STANDARIZATION MANUAL" AND "COMPRESSOR ID SHEETS".

No.	MODEL TECHNICAL VARIATION COOLING CAPACITY.	Note	[~]RMA- A 018 J	[~]RMA- A 024 J	[~]RMA- A 030 J	[~]RMA- A 036 J	[~]RMA- A 042 J	[~]RMA- A 048 J
-----	---	------	--------------------------	--------------------------	--------------------------	--------------------------	--------------------------	--------------------------

**ORIGINAL AND REPLACEMENT COMPRESSOR - READ NOTE ABOVE**

56	COMPRESSOR:							
	<i>Original Compressor ID Code</i>		<b>6229</b>	<b>5534</b>	<b>5535</b>	<b>5536</b>	<b>5537</b>	<b>6026</b>
	Original Compressor		55-23139-03	55-23139-44	55-23139-46	55-23139-57	55-23139-62	55-23139-25
	Replacement Compressor		55-23139-03s	55-23139-44s	55-23139-46s	55-23139-57s	55-23139-62s	55-23139-25Ss
29	DUAL RUN CAPACITOR-ROUND							
	<i>For Original Compressor</i>		43-23204-03 30/3/370 MFD/Volts	43-23204-33 40/3/370 MFD/Volts	43-23204-34 45/3/370 MFD/Volts	43-23204-14 50/3/370 MFD/Volts	43-23204-32 55/3/370 MFD/Volts	43-23204-19 60/5/370 MFD/Volts
	<i>For Replacement Compressor</i>		43-23204-03 30/3/370 MFD/Volts	43-23204-33 40/3/370 MFD/Volts	43-23204-34 45/3/370 MFD/Volts	43-23204-14 50/3/370 MFD/Volts	43-23204-32 55/3/370 MFD/Volts	43-23204-19 60/5/370 MFD/Volts
np	START KIT ACCESSORY		SK-A1-1	SK-A1-1	SK-A1-1	SK-A1-1	SK-A1-1	SK-A4-1
	Start Relay		42-18282-09	42-18282-09	42-18282-09	42-18282-09	42-18282-09	42-18282-09
	Start Capacitor		43-17075-04	43-17075-04	43-17075-04	43-17075-04	43-17075-04	43-17075-07

No.	MODEL TECHNICAL VARIATION COOLING CAPACITY.	Note	[~]RMA- A 036 C	[~]RMA- A 042 C	[~]RMA- A 048 C			
-----	---	------	--------------------------	--------------------------	--------------------------	--	--	--

**ORIGINAL AND REPLACEMENT COMPRESSOR - READ NOTE ABOVE**

56	COMPRESSOR:							
	<i>Original Compressor ID Code</i>		<b>5815</b>	<b>5816</b>	<b>6027</b>			
	Original Compressor		55-23139-58	55-23139-63	55-23139-26			
	Replacement Compressor		55-23139-58s	55-23139-63s	55-23139-26s			
29	DUAL RUN CAPACITOR-ROUND		dna	dna	dna			
np	START KIT ACCESSORY		dna	dna	dna			

No.	MODEL	Note	[-]RKA- [-]RMA- A 04	[-]RKA- [-]RMA- A 06	[-]RKA- [-]RMA- A 08	[-]RKA- [-]RMA- A 10			
<b>TECHNICAL VARIATION HEATING CAPACITY.</b>									
<b>HEAT EXCHANGER/COLLECTOR BOX/</b>									
<b>BURNER ASSEMBLY: BURNERS, MANIFOLD, ORIFICE, FLAME SENSOR, IGNITION ELECTRODE &amp; CABLE</b>									
37	HEAT EXCHANGER - Includes Center Panel & Turbulators		AS-58632-01	AS-58632-02	AS-58632-03	AS-58632-04			
np	COLLECTOR BOX GASKET	stk	68-23644-01	68-23644-01	68-23644-01	68-23644-01			
np	COLLECTOR BOX		AE-58588-01	AE-58588-01	AE-58588-01	AE-58588-01			
np	LIMIT CONTROL (On Blower Shelf)	nw	47-23610-11	47-23610-05 (018/024) 47-23610-03 (024/030) (036/042)	47-23610-03	47-23610-01			
<b>THE FOLLOWING PARTS ARE REPRESENTED IN THE DRAWING MARKED "BURNER ASSEMBLY/GAS VALVE".</b>									
62	RADIATION SHIELD		AE-58595-01	AE-58595-01	AE-58595-01	AE-58595-01			
63	OVERTEMPERATURE SWITCH	stk	47-22861-01	47-22861-01	47-22861-01	47-22861-01			
64	BURNER FLOOR		AE-58594-01	AE-58594-01	AE-58594-01	AE-58594-01			
I	BURNER ASSEMBLY CONSISTING OF:								
65	Burner	stk	75-22840-01 QTY 2	75-22840-01 QTY 3	75-22840-01 QTY 4	75-22840-01 QTY 5			
66	Burner Support - (Holds the Burners between the Burner Support Brackets)		AE-58592-01	AE-58592-01	AE-58592-01	AE-58592-01			
67	Burner Support Bracket (2)		AE-61588-01	AE-61588-01	AE-61588-01	AE-61588-01			
68	Manifold Less Orifices or Plugs	stk	81-23604-01	81-23604-01	81-23604-01	81-23604-01			
69	Square Head Plug - (Used on Manifold to Plug Extra Holes.)	nw	81-23593-01 QTY 3	81-23593-01 QTY 2	81-23593-01 QTY 1	dna			
71	Flame Sensor	stk	62-23543-02	62-23543-02	62-23543-02	62-23543-02			
72	Ignitor w/Cable	stk	62-23556-01	62-23556-01	62-23556-01	62-23556-01			

No.	MODEL	Note	[-]RKA- [-]RMA- A 04	[-]RKA- [-]RMA- A 06	[-]RKA- [-]RMA- A 08	[-]RKA- [-]RMA- A 10		
<b>TECHNICAL VARIATION HEATING CAPACITY.</b>								
<b>DIRECT SPARK IGNITION - HONEYWELL GAS CONTROL</b>								
<b>SERIAL CONTROL CODES - 1A, 1C, 1R</b>								
73	GAS VALVE - HW VR8205M1106	stk	60-22447-07	60-22447-07	60-22447-07	60-22447-07		
WARNING: WHEN CONVERTING NOx MODELS TO LP/PROPANE GAS REMOVE THE NOx BURNER INSERTS.								
np	LP/PROPANE GAS CONVERSION KIT	stk	[EP-85H]	[EP-85H]	[EP-85H]	[EP-85H]		
73 np	Gas Valve for LP/Propane, Use HW VR8205M1106, Natural & Spring Conversion Assembly	stk	60-22447-07 60-22513-01	60-22447-07 60-22513-01	60-22447-07 60-22513-01	60-22447-07 60-22513-01		
70	Burner Orifice - LP/Propane - (See Conversion Kit Index 92-21519-47 for Complete High Altitude Orifice Instructions)							
	U.S. Models 2,000' - 4,000' and Canadian Models 2,000' - 4,500' Elevation		62-21551-13 QTY 2	62-21551-13 QTY 3	62-21551-13 QTY 4	62-21551-13 QTY 5		
<b>DIRECT SPARK IGNITION - WHITE-RODGERS GAS CONTROL</b>								
<b>SERIAL CONTROL CODES - 1D, 1F, 1S</b>								
73	GAS VALVE - WR 36E36-274	nw	60-23490-03	60-23490-03	60-23490-03	60-23490-03		
WARNING: WHEN CONVERTING NOx MODELS TO LP/PROPANE GAS REMOVE THE NOx BURNER INSERTS.								
np	LP/PROPANE GAS CONVERSION KIT	alt	[EP-84W]	[EP-84W]	[EP-84W]	[EP-84W]		
73 np	Gas Valve for LP/Propane, Use WR 36E36-274, Natural & Spring Conversion Assembly	nw	60-23490-03 60-21193-01	60-23490-03 60-21193-01	60-23490-03 60-21193-01	60-23490-03 60-21193-01		
70	Burner Orifice - LP/Propane - (See Conversion Kit Index 92-21519-47 for Complete High Altitude Orifice Instructions)							
	U.S. Models 2,000' - 4,000' and Canadian Models 2,000' - 4,500' Elevation		62-21551-13 QTY 2	62-21551-13 QTY 3	62-21551-13 QTY 4	62-21551-13 QTY 5		