

This Owner's Manual is provided and hosted by [Appliance Factory Parts](#).



# DYNA-GLO RA18LPB-1 Owner's Manual

[Shop genuine replacement parts for DYNA-GLO  
RA18LPB-1](#)



[Find Your DYNA-GLO HVAC Parts - Select From 146 Models](#)

----- Manual continues below -----

# PROPANE CONSTRUCTION HEATER

## USER'S MANUAL AND OPERATING INSTRUCTIONS

MODEL # RA18LPDG, RA18LPDGD, RA18LPL  
RA18LPDGP, RA18LPA, RA18LPB, and RA18LPC



C US

ANS Z83.7-2011 CSA 2.14-2011



Adequate ventilation must be provided.



GHP Group, Inc.  
6440 W Howard St  
Niles, IL 60714-3302

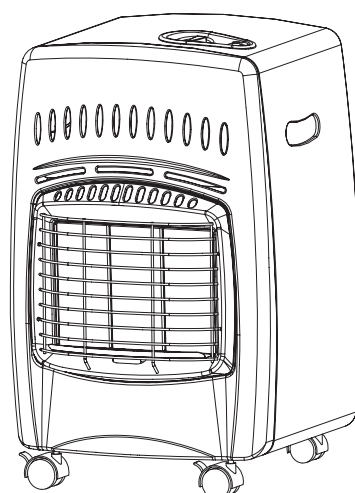

**IMPORTANT:** READ AND UNDERSTAND THIS MANUAL BEFORE ASSEMBLING, STARTING OR SERVICING HEATER. IMPROPER USE OF HEATER CAN CAUSE SERIOUS INJURY. KEEP THIS MANUAL FOR FUTURE REFERENCE.

**CALIFORNIA PROPOSITION 65:** Fuels used in gas or oil fired appliances and the products of combustion of such fuels, contain chemicals known to the State of California to cause cancer, birth defects or other reproductive harm. This product contains chemicals, including lead and lead compounds, known to the State of California to cause cancer, birth defects or other reproductive harm. **Wash hands after handling.**



### GENERAL HAZARD WARNING:

FAILURE TO COMPLY WITH THE PRECAUTIONS AND INSTRUCTIONS PROVIDED WITH THIS HEATER, CAN RESULT IN DEATH, SERIOUS BODILY INJURY AND PROPERTY LOSS, OR DAMAGE FROM THE HAZARDS OF FIRE, EXPLOSION, BURN, ASPHYXIATION, CARBON MONOXIDE POISONING, AND/OR ELECTRICAL SHOCK.

ONLY PERSONS WHO CAN UNDERSTAND AND FOLLOW THE INSTRUCTIONS SHOULD USE OR SERVICE THIS HEATER.

IF YOU NEED ASSISTANCE OR HEATER INFORMATION SUCH AS AN INSTRUCTION MANUAL, LABELS, ETCETERA, CONTACT THE MANUFACTURER.

**CONSUMER:** Retain this manual for future reference.

Questions, problems, missing parts? Before returning to your retailer, call our customer service department at 877-447-4768 8:30 a.m. – 4:30 pm CST, Monday – Friday or email us at [customerservice@ghpgroupinc.com](mailto:customerservice@ghpgroupinc.com)

# PROPANE CONSTRUCTION HEATER

## TABLE OF CONTENTS

General Safety Information .....	3 - 4
Specifications .....	5
Product Features .....	5
Unpacking and Assembly .....	6
Propane Supply .....	7
Connecting Heater to Gas Supply .....	8
Propane Safety .....	9
Checking For Leaks .....	9
Lighting & Shutdown Instructions .....	10 – 11
Storage of Heater .....	11
Moving and Positioning .....	11
Maintenance .....	12
Troubleshooting .....	13–14
Replacements Parts List .....	15
Exploded Parts Drawing .....	16
Warranty .....	17–18



**WARNING:** FIRE, BURN, INHALATION, AND EXPLOSION HAZARD, KEEP SOLID COMBUSTIBLES, SUCH AS BUILDING MATERIALS, PAPER OR CARDBOARD, A SAFE DISTANCE AWAY FROM THE HEATER AS RECOMMENDED BY THE INSTRUCTIONS.

NEVER USE THE HEATER IN SPACES WHICH DO OR MAY CONTAIN VOLATILE OR AIRBORNE COMBUSTIBLES, OR PRODUCTS SUCH AS GASOLINE, SOLVENTS, PAINT THINNERS, DUST PARTICLES OR UNKNOWN CHEMICALS.



**WARNING!**

**NOT FOR HOME OR RECREATIONAL VEHICLE USE.**

**NEVER LEAVE THE HEATER UNATTENDED WHILE BURNING!**

# PROPANE CONSTRUCTION HEATER

## GENERAL SAFETY INFORMATION

### *Radiant Propane Construction Heaters*

The heater is designed and approved for use as a construction heater under ANS Z83.7 CSA 2.14. It is hard to anticipate every use which may be made of this heater. **CHECK WITH YOUR LOCAL FIRE SAFETY AUTHORITY IF YOU HAVE QUESTIONS ABOUT APPLICATIONS.**

Other standards govern the use of fuel gases and heat producing products in specific applications. Your local authority can advise you about these.

**IMPORTANT:** READ THIS USER'S MANUAL CAREFULLY AND COMPLETELY BEFORE TRYING TO OPERATE OR SERVICE THIS HEATER. IMPROPER USE OF THIS HEATER CAN CAUSE SERIOUS INJURY OR DEATH FROM FIRE, EXPLOSION AND CARBON MONOXIDE POISONING.

This is a direct-fired cabinet construction heater for indoor construction. The heater must be placed where it is not directly exposed to water spray, rain, and/or dripping water. Its intended use is primarily the temporary heating of buildings or structures under construction, alteration or repair. All the products of combustion generated by the heater are released into the area being heated. This heater operates at approximately 99% combustion efficiency but still produces a small amount of carbon monoxide. Humans can tolerate small amounts of carbon monoxide for short periods. Carbon monoxide can build up in a heated space and failure to provide adequate ventilation could result in poisoning or death.

 **WARNING:** NOT FOR USE WITH DUCTWORK.

## IMPORTANT INSTRUCTIONS - Safety Information

**NEVER LEAVE HEATER UNATTENDED WHILE BURNING  
OR WHILE CONNECTED TO A FUEL SOURCE.**

 **WARNING** FIRE, BURN, INHALATION, AND EXPLOSION HAZARD. KEEP SOLID COMBUSTIBLES, SUCH AS BUILDING MATERIALS, PAPER OR CARDBOARD, A SAFE DISTANCE AWAY FROM THE HEATER AS RECOMMENDED BY THESE INSTRUCTIONS. NEVER USE THE HEATER IN SPACES WHICH DO OR MAY CONTAIN VOLATILE OR AIRBORNE COMBUSTIBLES, OR PRODUCTS SUCH AS GASOLINE, SOLVENTS, PAINT THINNERS, DUST PARTICLES OR UNKNOWN CHEMICALS.

 **CAUTION** THIS IS AN UNVENTED PORTABLE HEATER. IT USES AIR (OXYGEN) FROM THE AREA WHICH IT IS USED. AMPLE COMBUSTION AND VENTILATION AIR MUST BE PROVIDED.

 **WARNING** IF THE INFORMATION IN THIS MANUAL IS NOT FOLLOWED EXACTLY, A FIRE OR EXPLOSION MAY RESULT CAUSING PROPERTY DAMAGE, PERSONAL INJURY OR LOSS OF LIFE.

- ⇒ DO NOT STORE OR USE GASOLINE OR OTHER FLAMMABLE VAPORS AND LIQUIDS IN THE VICINITY OF THIS OR ANY OTHER APPLIANCE.
- ⇒ AN LP CYLINDER NOT CONNECTED FOR USE SHALL NOT BE STORED IN THE VICINITY OF THIS OR ANY OTHER APPLIANCE.

**NEVER LEAVE THE HEATER  
UNATTENDED WHILE BURNING!**

# **PROPANE CONSTRUCTION HEATER**

## **GENERAL SAFETY INSTRUCTIONS**

Accidents are always tragic especially because so many of them could have been prevented with little care and judgment. There are some basic good practices, we hope you will follow for safe use of your heater.

## **IMPORTANT SAFETY INFORMATION**

- Children and pets should be carefully supervised, when they are in the area.
- Always maintain proper clearance from combustible materials. Minimum clearance from combustibles: Front: 3' (92 cm) Top: 2' (60 cm) Side & Rear: 1' (30 cm) Floor: Combustible, not for use on finished floors.
- Heater must be placed on level and stable surface.
- Never place anything including clothes or other flammable items on the heater.
- The appliance area shall be kept clear and free from combustible materials, gasoline and other flammable vapours and liquids.
- Do not modify or operate a heater which has been modified.
- Adequate clearance for accessibility and for combustion & ventilation air supply must be maintained at all times when the heater is operating.
- Service and repair should be done by a qualified service person. The heater should be inspected before each use and at least annually by a qualified person. More frequent cleaning may be required as necessary. Do not service while hot or operating.
- Never connect heater to an unregulated gas supply.
- The heater is shipped from the factory for LP(Propane) gas. This heater is for use with propane gas only, do not convert heater to any other gas. Installation must conform to local codes or, in the absence of local codes, with the standard for the Storage and Handling of Liquefied Petroleum Gases ANSI/NFPA 58 and the Natural Gas and Propane Installation Code CSA B149.1
- The minimum and maximum inlet pressures to the regulator from the gas tank are 5 psi and bottle pressure, respectively. Use only the regulator & hose assembly provided with the heater. Inspect the regulator/hose assembly prior to each use of the heater. If there is excessive abrasion or wear, or hose is cut, replace with regulator/hose assembly listed on the parts list prior to using this heater.
- Gas supply connections should be checked using a 50/50 solution of liquid dish soap and never use a flame to check for gas leaks.
- This heater needs fresh outside air for combustion to run properly. This heater has an oxygen depletion sensor (ODS) pilot safety system. The ODS shuts down the heater if not enough fresh air (>18%) is available.
- Do not restrict inlet or outlet by any means. The flow of combustion and ventilation air is not to be obstructed.
- This heater should not be directed toward any propane-gas container within 20 ft (6M). The heater must be located at least 6 ft. (1.83 m) in the U.S.; or (ii) 10 ft. (3 m) in Canada, from any other propane gas container.
- The propane cylinder supply system must be arranged to provide for vapour withdrawal from the operating cylinder.
- Children and adults should be alerted to the hazard of high surface temperatures and should stay away to avoid burns and clothing ignition. Young children should be carefully supervised when they are in the same room with the appliance. Never allow them to sit, stand or play on or around the appliance.
- Make sure that if the safety screen or guard is removed for servicing the appliance that it is replaced prior to operating the appliance.
- Do not use the heater if any part has been under water. Immediately call a qualified service technician to inspect the appliance and replace any part of the control system which has been under water.

**NEVER LEAVE THE HEATER  
UNATTENDED WHILE BURNING!**

# PROPANE CONSTRUCTION HEATER

## SPECIFICATIONS

### *Vent Free Radiant Heater - Propane Vapor Only*

Fuel Type ..... Propane Vapor Only  
 Ignition Type ..... Piezo Electric/ODS Pilot  
 Min Operating Temperature ..... 0°F (-18°C)  
 Clearances to Combustibles ..... Front: 3' (92cm), Top: 2' (60cm), Sides: and Rear: 1' (30cm),  
 Floor: Combustible, not for use on finished floors.

Model #	Input Rating (BTU/Hr)			Supply Pressure		Manifold Pressure	Gas Consumption		Size ( Assembled) (L X W X H)
	High	Medium	Low	Maximum	Minimum		lb/h	kg/h	
RA18 Series	18,000	12,000	6,000	Bottle Pressure	5psi	11.0" WC	0.83/0.28	0.377/0.127	15.75"x14.96"x23.35" (40 x 38 x 59.3 cm)

## PRODUCT FEATURES

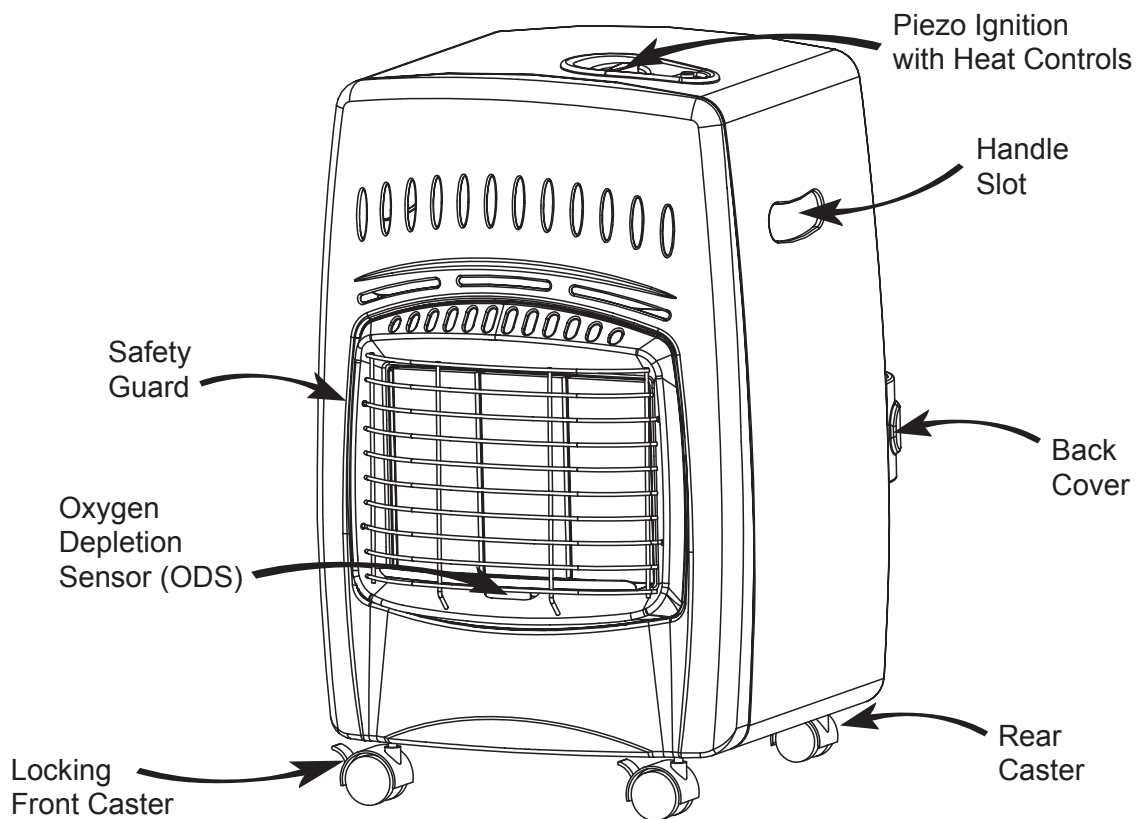

**NEVER LEAVE THE HEATER UNATTENDED WHILE BURNING!**

# PROPANE CONSTRUCTION HEATER

## CONTENTS

1. Unit
2. Rear Guard
3. Manual
4. Hardware Kit

Includes:

M8 Flat Washers(4) Locking Casters(2) Non Locking Casters(2) 14 mm Wrench(1)

**Estimated Assembly Time:**  
10 Minutes

**Tools Required:**  
14 mm Wrench (Included)

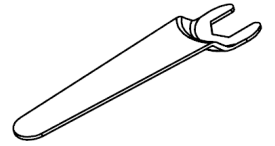
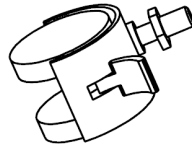
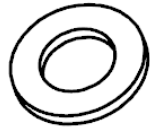

## UNPACKING THE HEATER

1. Remove heater from carton.
2. Remove all protective packaging applied to heater for shipment.
3. Retain carton and packing material until you confirm the unit operates and is found in good condition.
4. Check heater for any shipping damage. If heater shows any external or internal damage, promptly inform dealer/distributor where you purchased heater.
5. Remove back cover.
6. Locate the four (4) casters shipped with the unit. There are two (2) locking casters and two non-locking casters. Also find the four (4) washers and wrench shipped with the casters.
7. Carefully lay the unit on its back.
8. Place one washer on each of the threaded portions of the caster. (see Figure 1).
9. Thread the casters into the four threaded holes in the base of the unit by turning them clockwise . The locking casters should be placed at the front of the unit and the other two at the back of the unit. (See Figure 1).
10. Tighten The casters using the wrench supplied with the casters.
11. Install 20 lb propane cylinder. (see Propane Supply section)
12. Install back cover by inserting the mounting tabs into the slots on the rear flange of the heater.

 **CAUTION:** The casters must be installed onto the unit before it is used. Failure to install the casters may result in a fire or explosion causing property damage, personal injury or loss of life.

**FIGURE 1**

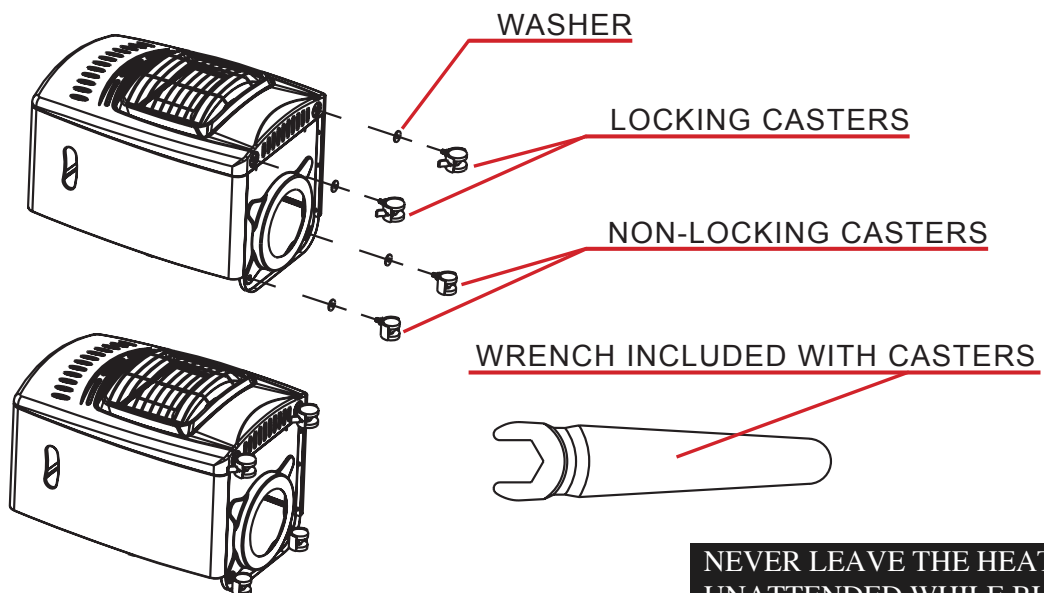

**NEVER LEAVE THE HEATER  
UNATTENDED WHILE BURNING!**



# PROPANE CONSTRUCTION HEATER

## PROPANE SUPPLY

You must provide the propane gas and cylinder(s). Use this heater only with a propane vapor withdrawal supply system. Refer to Chapter 5 of the Standard for Storage and Handling of Liquefied Petroleum Gas, ANSI/NFPA 58. Your local library or fire department will have this booklet.

- The cylinder must be equipped with a collar to protect the gas valve, an arrangement of vapor withdrawal, a shutoff valve terminating the cylinder valve outlet as specified in the American National Standard for Compressed Gas Cylinder Valve Outlet and Inlet Connections, and a safety relief valve in direct contact with the vapor space of the tank.
- Always keep the cylinder in an upright position. Avoid knocking the cylinder over on its side with the hose/regulator connected, as this can cause damage to the regulator diaphragm.
- Never store a propane (LP) cylinder indoors or in the vicinity of any gas burning appliances.
- Protect the cylinder valve, and handle it with care.
- Be sure that the shut-off valve is closed tightly after each use.
- Be sure to protect the POL fitting from damage when disconnected. Damage to this fitting can lead to leaks.
- The hose assembly shall be visually inspected prior to each use of the heater. If it is evident that there is excessive abrasion or wear, or the hose is cut, it must be replaced prior to the heater being put into operation. The replacement hose assembly shall be that specified by the manufacturer.
- Never connect an unregulated cylinder to the heater. Always use the hose and regulator supplied.
- Never use any other hose and regulator.
- Do not subject the cylinder to excessive heat.

**NEVER LEAVE THE HEATER  
UNATTENDED WHILE BURNING!**



# PROPANE CONSTRUCTION HEATER

## CONNECTING TO GAS SUPPLY

**IMPORTANT!** ALWAYS USE A PROPANE (LP) CYLINDER THAT HAS A CONNECTION DEVICE THAT IS COMPATIBLE WITH THE HOSE AND REGULATOR ASSEMBLY SUPPLIED.

**CAUTION** THE PROPANE (LP) GAS PRESSURE REGULATOR AND HOSE ASSEMBLY SUPPLIED WITH THE HEATER MUST BE USED WITHOUT ALTERATION. BE SURE TO INSPECT THE REGULATOR HOSE BEFORE EACH USE. IF THE HOSE IS CUT OR FRAYED, REPLACE IT WITH THE MANUFACTURER SUGGESTED ASSEMBLY.

1. Provide propane/LP supply system (see Propane Supply, page 7).
2. Insert the 20 lb (9 kg) propane cylinder into the rear of the heater and position it such that the outlet of the cylinder valve is facing towards the front-left corner of the unit. See Figure 2.
3. Connect the fitting of the hose/regulator assembly to the cylinder outlet. Turn the fitting counterclockwise  into the threads of the cylinder valve. Some models have a hand wheel that can be slid off the nut so that a wrench can be used to tighten the fitting, if desired.

**CAUTION** Position the regulator such that the side with the tower is facing down and the flat side is facing up. See Figure 2.

**WARNING** Ensure that the gas hose is not touching the unpainted heat shield at the front of the cylinder enclosure. See Figure 2.

4. Open propane/LP supply valve on propane/LP tank(s) slowly.

NOTE: If not opened slowly, excess flow device in regulator may stop gas flow. If this happens, close propane/LP supply valve, wait one minute (or until you hear a click) and open again slowly.

5. Check all connections for leaks. Apply a 50/50 solution of liquid dish soap and water to gas joints. Bubbles forming show a leak that must be corrected.
6. Close propane / LP supply valve before attempting to repair connection.

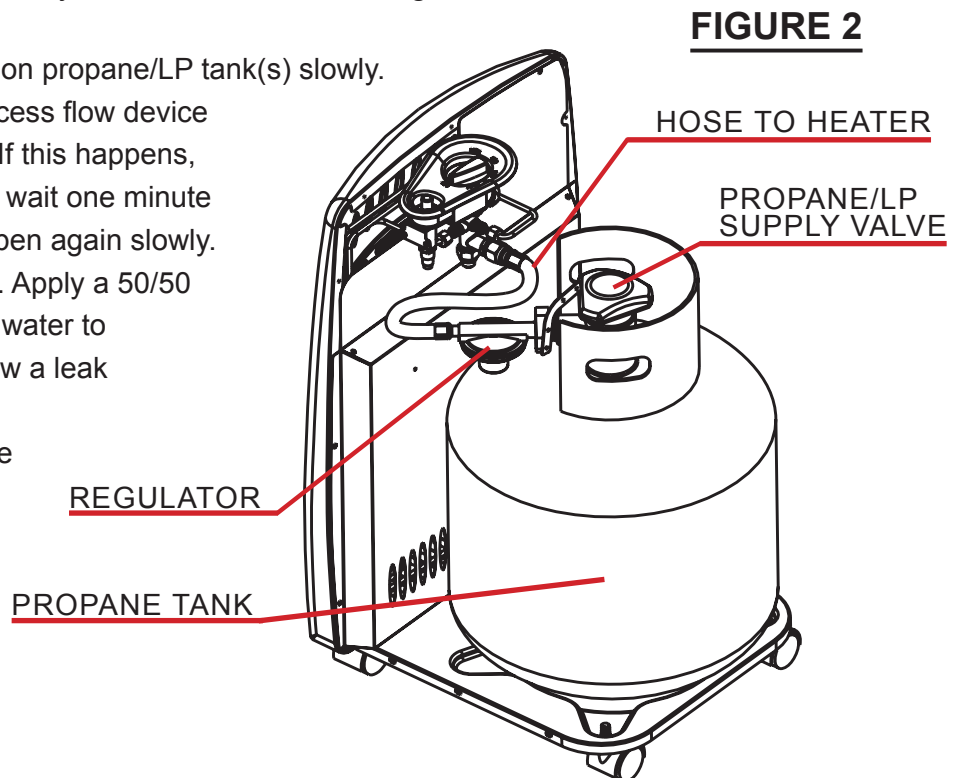

**NEVER LEAVE THE HEATER UNATTENDED WHILE BURNING!**

# PROPANE CONSTRUCTION HEATER

## PROPANE SAFETY

Propane is safe to use when properly handled. Careless handling of the Propane gas tank could result in fire and/or an explosion. Therefore:

- Always keep tank/cylinder securely fastened in an upright position.
- Avoid tipping tank on its side when connected to a regulator since this may cause damage to diaphragm in regulator.
- Handle valves with care.
- Never connect an unregulated Propane tank to construction heater.
- Do not subject Propane tank to excessive heat.
- Tightly close the gas shutoff valve on the Propane tank after each use.
- The POL fitting must be protected when disconnected from the propane tank.
- Never store a Propane gas tank inside a building or in the vicinity of any gas burning appliance.

**THE DISCONNECTED TANK MUST NEVER BE STORED IN A BUILDING,  
GARAGE OR ANY OTHER ENCLOSED AREA.**

## CHECKING FOR LEAKS

Check all gas connections with a soap solution to be sure they are tight and leak proof. Soap bubbles indicate gas leakage that must be corrected.

- The installation of your heater must meet all local codes and/or gas utility requirements or, in the absence of local codes, with the Storage and Handling of Liquefied Petroleum Gases, ANSI/NFPA 58 and the Natural and Propane Installation Code, CSA B149.1.
- Do not use a match or flame to check for gas leaks.
- The hose assembly should be visually inspected prior to each use of the heater. If it is evident that there is excessive abrasion or wear, or the hose is cut, it must be replaced prior to the heater being put into operation.
- The replacement hose assembly shall be that specified by the manufacturer (See page 17 for part numbers).

 **WARNING** PURGING AND FILLING OF LP GAS TANKS MUST BE PERFORMED BY PERSONNEL WHO HAVE BEEN THOROUGHLY TRAINED IN ACCEPTED LP GAS INDUSTRY PROCEDURES. FAILURE TO FOLLOW THESE INSTRUCTIONS MAY RESULT IN EXPLOSION, FIRE, SEVERE PERSONAL INJURY, OR DEATH.

**NEVER LEAVE THE HEATER  
UNATTENDED WHILE BURNING!**

# PROPANE CONSTRUCTION HEATER

## LIGHTING INSTRUCTIONS

1. STOP! Read and heed warnings and cautions on the side of the heater.

2. Check that the gas supply to the heater is on.

3. Push in gas control knob slightly and turn clockwise  to OFF (○) position. (A)

**Note:** knob cannot be turned from PILOT (★) position to OFF (○) unless the knob is pushed in slightly. Do not force.

4. Wait five (5) minutes to clear any gas. Then smell for gas, including near the floor. If you smell gas, STOP! Follow the leak checking section in the manual. If you do not smell gas, go to next step.

5. Push in the gas control knob slightly and turn counterclockwise  to PILOT (★) position and depress for 5 seconds. (B)

**Note:** The first time that the heater is operated after connecting the gas supply, the control knob should be depressed for at least 30 seconds. This will allow air to bleed from the gas system.

6. Depress control knob while depressing the piezo ignitor button (⚡). This should cause the spark from the piezo ignitor to light the pilot gas. Keep control knob depressed thirty (30) seconds before releasing. If the pilot does not light, depress the control knob and turn to the OFF (○) position. Repeat steps 5 and 6.

7. When pilot is lit, turn the knob counterclockwise  to desired heat level, LOW (●), MEDIUM (●●), or HIGH (●●●). (C)

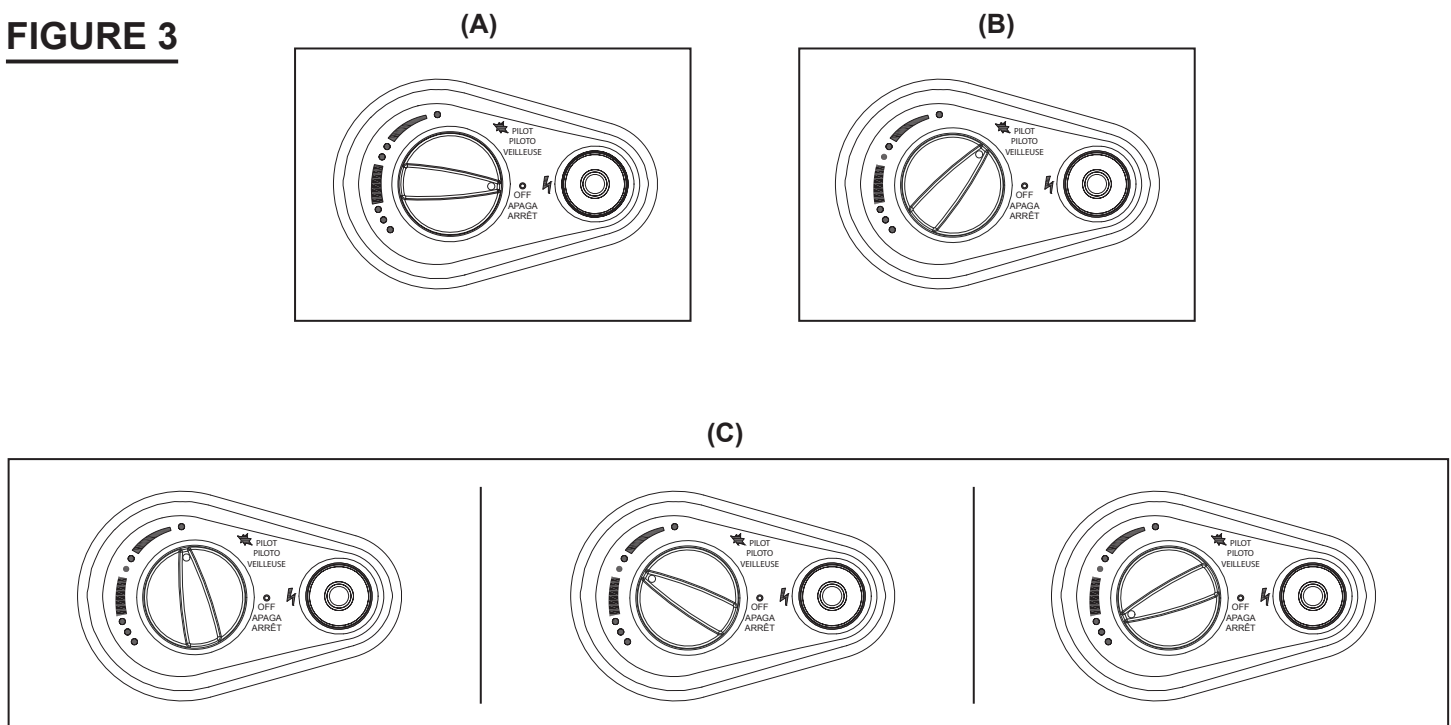

**FIGURE 3**



**NEVER LEAVE THE HEATER  
UNATTENDED WHILE BURNING!**

# PROPANE CONSTRUCTION HEATER

## SHUTDOWN INSTRUCTIONS

1. Push in gas control knob slightly and turn clockwise  to OFF (O) position. Do not force. (A)
2. Turn gas supply off by turning propane tank valve clockwise  to close.

**Turning burner only OFF (pilot stays lit).**

Turn control knob clockwise  to PILOT (★) position. (B)

## STORAGE

Never store a Propane gas tank inside a building or in the vicinity of any gas or oil burning appliance. When the Propane tank is not disconnected from the construction heater, the gas tank and heater must be stored outdoors in a well ventilated area, out of the reach of children. If for any reason the heater is to be stored indoors, the tank must be disconnected and stored outdoors in a well ventilated area out of reach of children, in accordance with the standard for the the Storage and Handling of Liquefied Petroleum Gases, ANSI / NFPA 58 and CSA B149.1, Natural Gas and Propane Installation Code. The plastic tank valve plug supplied with your tank must be tightly installed when the tank is disconnected from the heater.

## MOVING AND POSITIONING HEATER

There is a brake in each of the front wheels of your heater that helps keep it in place when in use. To engage the brakes, push the lever down on each wheel. To move the heater, release the brakes, simply by flipping the levers on both brakes up.

**NEVER LEAVE THE HEATER  
UNATTENDED WHILE BURNING!**

# PROPANE CONSTRUCTION HEATER

## MAINTENANCE

Repair should be done by a qualified service person. The appliance should be inspected before use and at least annually by a professional service person. More frequent cleaning may be required due to excessive debris. It is imperative that control compartments, burners and circulating air passageways of the heater be kept clean. Dust, lint, cobwebs or debris may affect heater performance. The heater draws air into it during normal operation and in the process dust, lint or debris may be drawn into it. Before cleaning ensure the gas supply is turned off at the cylinder and the gas control knob is in the "OFF" position.

### *Pilot and Burning Inspection*

Each time you light the heater check that the pilot flame and burner flame patterns are as shown in figures 4 and 5. If flame patterns are incorrect, turn the heater off and contact your dealer or qualified service person for assistance. Do not operate the heater until the pilot and burner flames are correct.

Note: Do not mistake orange flames with yellow tipping. Dirt or dust particles may enter the burner flames and cause transient patches of orange flame.

**FIGURE 4** Proper Pilot Flame

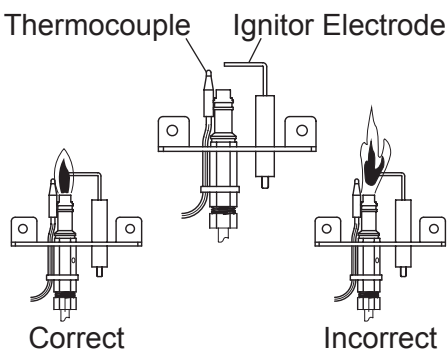

**FIGURE 5**  
Correct Burner Flame Pattern

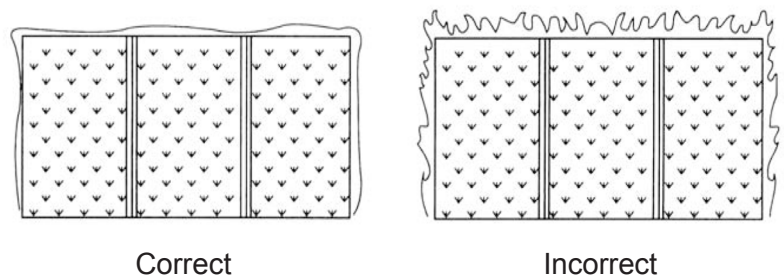

### *Burner and ODS Pilot Cleaning*

Clean the exterior with soft bristle brush, vacuum cleaner or pressurized air. Never use a wooden toothpick as it may break off and clog the ODS pilot or main burner port.

Use a flashlight to inspect the main burner inlet to ensure it is not blocked. If obstruction can be seen, use a metal coat hanger that has been straightened out. Use a vacuum cleaner to clean the primary air openings to the main burners.

**WARNING:** FAILURE TO KEEP THE PRIMARY AIR OPENINGS TO THE BURNER(S) CLEAN "MAY RESULT IN SOOTING, PROPERTY DAMAGE AND INCREASED CARBON MONOXIDE PRODUCTION".

In order to clean ODS pilot orifice, use pressurized air to blow dust out through the primary air opening on the side of the pilot.

### *Cleaning Air Passageways and Unit Casings*

Use a vacuum cleaner or pressurized air to clean the combustion and circulating air passageways and a damp cloth to clean the cabinet/casing.

**NEVER LEAVE THE HEATER UNATTENDED WHILE BURNING!**

# PROPANE CONSTRUCTION HEATER

## TROUBLESHOOTING

Problem	Possible Cause	What To Do
When ignitor is depressed there is no spark at ODS pilot.	<ol style="list-style-type: none"> <li>1. Ignitor electrode positioned wrong.</li> <li>2. Ignitor electrode broken.</li> <li>3. Ignitor cable pinched or broken.</li> <li>4. Ignitor cable not connected to ignitor electrode.</li> <li>5. Ignitor defective.</li> </ol>	<ol style="list-style-type: none"> <li>1. Reposition ignitor electrode.</li> <li>2. Replace electrode.</li> <li>3. Free ignitor cable, if damaged, replace.</li> <li>4. Connect cable to electrode.</li> <li>5. Replace ignitor.</li> </ol>
When control knob is pressed in and turned counterclockwise to pilot and piezo is depressed, pilot does not light.	<ol style="list-style-type: none"> <li>1. Gas supply turned off.</li> <li>2. Control knob not in pilot position.</li> <li>3. Control knob not pressed in while in pilot position.</li> <li>4. ODS pilot is clogged.</li> <li>5. Air in gas lines.</li> </ol>	<ol style="list-style-type: none"> <li>1. Turn gas supply on.</li> <li>2. Turn control knob to pilot position.</li> <li>3. Press in control while in pilot position.</li> <li>4. Call a qualified service technician.</li> <li>5. Purge gas lines and repeat ignition operation.</li> </ol>
ODS pilot lights but flame goes out when control knob is released.	<ol style="list-style-type: none"> <li>1. Control knob not pressed long enough.</li> <li>2. Safety interlock is triggered.</li> <li>3. Pilot flame not touching the thermocouple. Problem could be result of one or both of the following: <ul style="list-style-type: none"> <li>• Partially clogged ODS pilot orifice.</li> <li>• Low gas pressure.</li> </ul> </li> <li>4. Thermocouple damaged.</li> <li>5. Thermocouple connection loose at gas control valve.</li> <li>6. Gas control valve damaged.</li> </ol>	<ol style="list-style-type: none"> <li>1. After ODS pilot lights, keep control knob pressed in approximately 30 seconds.</li> <li>2. Wait one minute, repeat ignition operation.</li> <li>3. Contact your gas company, gas supplier or qualified service technician.</li> <li>4. Replace thermocouple.</li> <li>5. Hand tight until snug then tighten 1/4 turn with a wrench.</li> <li>6. Replace gas control.</li> </ol>
Burner does not light after ODS pilot is lit.	<ol style="list-style-type: none"> <li>1. Burner orifice clogged.</li> <li>2. Gas supply pressure is very low.</li> </ol>	<ol style="list-style-type: none"> <li>1. Clean burner orifice.</li> <li>2. Contact gas supplier.</li> </ol>
Delayed ignition.	<ol style="list-style-type: none"> <li>1. Main burner carry over ports clogged.</li> <li>2. Gas supply pressure is very low.</li> </ol>	<ol style="list-style-type: none"> <li>1. Clean main burner ports.</li> <li>2. Contact gas supplier.</li> </ol>
Burner backfiring during operation.	<ol style="list-style-type: none"> <li>1. Burner orifice is clogged.</li> <li>2. Burner ports damaged.</li> </ol>	<ol style="list-style-type: none"> <li>1. Clean burner orifice.</li> <li>2. Replace burner.</li> </ol>
Yellow flames during burner operation.	<ol style="list-style-type: none"> <li>1. Not enough air.</li> </ol>	<ol style="list-style-type: none"> <li>1. Check air passageways and burner for dirt and debris. (Refer to Maintenance section)</li> </ol>
Burner plaque(s) does not glow.	<ol style="list-style-type: none"> <li>1. Plaque(s) is damaged.</li> <li>2. Inlet gas pressure too low.</li> <li>3. Control knob set between locked positions.</li> </ol>	<ol style="list-style-type: none"> <li>1. Replace burner.</li> <li>2. Contact local gas supplier.</li> <li>3. Turn control knob until it locks at desired setting.</li> </ol>
Slight smoke and odor during Initial operation.	<ol style="list-style-type: none"> <li>1. Residues from manufacturing processes.</li> </ol>	<ol style="list-style-type: none"> <li>1. Will stop after a few hours of operation.</li> </ol>
Heater produces a whistling noise when burner is lit.	<ol style="list-style-type: none"> <li>1. Air passageways blocked.</li> <li>2. Air in gas line.</li> </ol>	<ol style="list-style-type: none"> <li>1. Check minimum installation clearances and air passageways for debris.</li> <li>2. Operate burner until the air is completely purged.</li> </ol>
Heater produces a clicking noise just after burner is lit or turned off.	<ol style="list-style-type: none"> <li>1. Metal expanding and contracting.</li> </ol>	<ol style="list-style-type: none"> <li>1. This is common with heaters. If noise is excessive, contact a qualified, service technician.</li> </ol>

**NEVER LEAVE THE HEATER UNATTENDED WHILE BURNING!**

# PROPANE CONSTRUCTION HEATER

## ***TROUBLESHOOTING (continued)***

<b>Problem</b>	<b>Possible Cause</b>	<b>What To Do</b>
Gas odor even when control knob is in OFF position.	<ol style="list-style-type: none"><li>1. Gas leaks. Refer to front of page Warnings.</li><li>2. Gas control defective.</li></ol>	<ol style="list-style-type: none"><li>1. Locate and correct leaks immediately.</li><li>2. Replace gas control</li></ol>
Gas odor during combustion.	<ol style="list-style-type: none"><li>1. Foreign matter in gas or on burner ports.</li><li>2. Heater burning vapors from paint, impurities in air.</li><li>3. Gas leaks, refer to front page Warnings</li></ol>	<ol style="list-style-type: none"><li>1. Check gas passage way and burner.</li><li>2. Ventilate room, stop storing and using odor causing products near heater.</li><li>3. Locate and correct leaks immediately.</li></ol>
Heater shuts off on ODS.	<ol style="list-style-type: none"><li>1. Not enough fresh air is available.</li><li>2. Low gas pressure.</li><li>3. ODS pilot partially clogged.</li></ol>	<ol style="list-style-type: none"><li>1. Open window.</li><li>2. Contact gas supplier.</li><li>3. Clean the pilot.</li></ol>



# PROPANE CONSTRUCTION HEATER

## REPLACEMENT PARTS LIST

### RA18 SERIES

Item/Model Number	Part No.
1. Lower Shield	PT-N11B-8
2. Guard Assembly	PT-N11B-3
3. Front Panel	PT-N11B-1
4. Reflector	PT-N11B-2
5. ODS Assembly	PT-N11B.6
6. Burner Assembly	PT-N11B.4
7. Gas Valve	GS7
8. Piezo Ignitor	PT-N11B.5
9. Knob Base	PT-N11B-10

Item/Model Number	Part No.
10. Tilt Switch	FD4
11. Gas Pipe	PT-N11B-7
12. Regulator & Hose Assembly	KR-106-01 (HW-350)
13. Rear Chassis	PT-N11B-4
14. Castor With Lock	PT-N06-33
15. Castor Without Lock	PT-N06-32
16. Heat Insulation Board	PT-N11-6
17. Back Cover	PT-N11B.2-1
18. Knob	PT-N06-24

### **WARNING!**

This heater is not intended for residential use.

**NEVER LEAVE THE HEATER  
UNATTENDED WHILE BURNING!**

# PROPANE CONSTRUCTION HEATER

## EXPLODED PARTS DRAWING

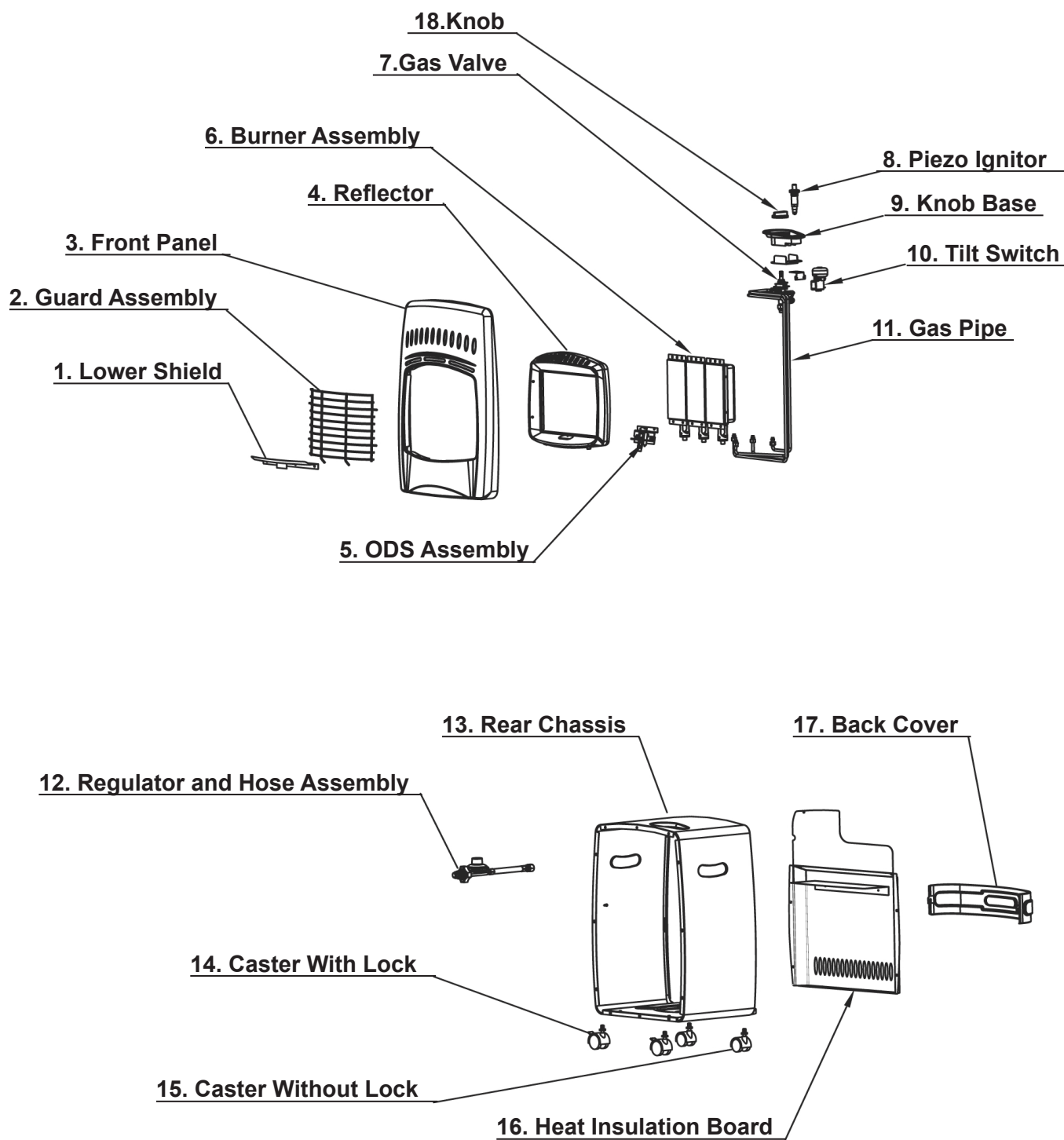

**NEVER LEAVE THE HEATER  
UNATTENDED WHILE BURNING!**

# WARRANTY

## LIMITED WARRANTY:

This limited warranty is extended to the original retail purchaser of this Forced Air/Convection/Radiant Heater and warrants against any defect in materials and workmanship for a period of one (1) year from the date of retail sale. GHP Group, Inc., at its option, will either provide replacement parts or replace or repair the unit, when properly returned to the retailer where purchased or one of our service centers as directed by GHP Group, Inc., within one (1) year of retail purchase. (Shipping costs, labour costs, etc. are the responsibility of the purchaser.)

## DUTIES OF THE OWNER:

This heating appliance must be operated in accordance with the written instructions furnished with this heater. This warranty shall not excuse the owner from properly maintaining this heater in accordance with the written instructions furnished with this heater. A bill of sale, canceled check or payment record must be kept to verify purchase date and establish warranty period. Original carton should be kept in case of warranty return of unit.

## WHAT IS NOT COVERED:

1. Damage resulting from use of improper fuel.
2. Damage caused by misuse or use contrary to the owners manual and safety guidelines.
3. Damage caused by a lack of normal maintenance.
4. Fuses
5. Use of non-standard parts or accessories.
6. Damage caused in transit. Freight charges on warranty parts or heaters to and from the factory shall be the responsibility of the owner.

This warranty does not imply or assume any responsibility for consequential damages that may result from the use, misuse, or the lack of routine maintenance of this heating appliance. A cleaning fee and the cost of parts may be charged for appliance failures resulting from lack of maintenance. This warranty does not cover claims which do not involve defective workmanship or materials. **FAILURE TO PERFORM GENERAL MAINTENANCE (INCLUDING CLEANING) WILL VOID THIS WARRANTY.**

THIS LIMITED WARRANTY IS GIVEN TO THE PURCHASER IN LIEU OF ALL OTHER WARRANTIES, EXPRESSED OR IMPLIED, INCLUDING BUT NOT LIMITED TO THE WARRANTIES OF MERCHANTABILITY OF FITNESS FOR A PARTICULAR PURPOSE. THE REMEDY PROVIDED IN THIS WARRANTY IS EXCLUSIVE AND IS GRANTED IN LIEU OF ALL OTHER REMEDIES. IN NO EVENT WILL GHP GROUP, INC. BE LIABLE FOR INCIDENTAL OR CONSEQUENTIAL DAMAGES.

Some states do not allow limitations on how long an implied warranty lasts, so the above limitation may not apply to you. Some states do not allow the exclusion or limitation of incidental or consequential damages so the above limitation or exclusion may not apply to you.

## CLAIMS HANDLED AS FOLLOWS:

1. Contact your retailer and explain the problem.
2. If the retailer is unable to resolve the problem, contact our Customer Service Dept. detailing the heater model, the problem, and proof of date of purchase.
3. A representative will contact you. DO NOT RETURN THE HEATER TO GHP GROUP, INC. unless instructed by our Representative. This warranty gives you specific legal rights and you may also have other rights which vary from state to state.

TO REGISTER THE WARRANTY ON YOUR HEATER, PLEASE FILL OUT THIS CARD COMPLETELY AND MAIL WITHIN 14 DAYS FROM DATE OF PURCHASE OR REGISTER ON-LINE AT [www.ghpgroupinc.com](http://www.ghpgroupinc.com)

NAME: \_\_\_\_\_ PHONE: (     ) \_\_\_\_\_ EMAIL: \_\_\_\_\_  
ADDRESS: \_\_\_\_\_ CITY: \_\_\_\_\_ STATE: \_\_\_\_\_ ZIP: \_\_\_\_\_  
MODEL: \_\_\_\_\_ SERIAL #: \_\_\_\_\_ DATE PURCHASED: \_\_\_\_\_  
DEALER PURCHASED FROM: \_\_\_\_\_ TYPE OF STORE: \_\_\_\_\_  
CITY & STATE WHERE PURCHASED: \_\_\_\_\_ PRICE PAID: \_\_\_\_\_

### Please Take a Minute To Give Us Your Answers To The Following Questions.

#### All Responses Are Used Solely For Market Research And Are Held In Strict Confidence.

Who primarily decided this purchase?  Male  Female  18-24  25-39  40-59  60 and over

Purpose of Purchase? \_\_\_\_\_

Do you own any other portable heaters?  Yes  No If yes, type \_\_\_\_\_ brand \_\_\_\_\_

How do you intend to use your new heater?  Construction Site  Farm  Warehouse/Commercial  Garage/Outbuilding  Other

How did you become aware of this heater?  In-Store Display  Newspaper Ad  Magazine Ad  Friend/Relative

TV Commercial  Store Salesperson  Other \_\_\_\_\_

What made you select this heater?  Style  Size/Portability  Price  Package  Brand  Other \_\_\_\_\_

Do you:  own  rent Would you recommend this heater to a friend?  Yes  No

Please give us your comments: \_\_\_\_\_

THANK YOU FOR COMPLETING THIS FORM!

Information will be held confidential.

## WARRANTY REGISTRATION

**IMPORTANT:** We urge you to fill out your warranty registration card within fourteen (14) days of date of purchase. You can also register your warranty on the internet at [www.ghpgroupinc.com](http://www.ghpgroupinc.com). Complete the entire serial number. Retain this portion of the card for your records.



**GHP Group, Inc.**  
6440 W Howard St  
Niles, IL 60714-3302  
  
Tel: (877) 447-4768  
[www.ghpgroupinc.com](http://www.ghpgroupinc.com)

**SAVE THIS CARD!**

Place  
Postage  
Stamp  
Here

**GHP Group, Inc.**  
6440 W Howard St  
Niles, IL 60714-3302