

This Owner's Manual is provided and hosted by [Appliance Factory Parts](#).



# DYNA-GLO RMC-55R7-1 Owner's Manual

[Shop genuine replacement parts for DYNA-GLO  
RMC-55R7-1](#)



[Find Your DYNA-GLO HVAC Parts - Select From 146 Models](#)

----- Manual continues below -----

# *PORTABLE KEROSENE-HEATER “OWNER’S MANUAL”*

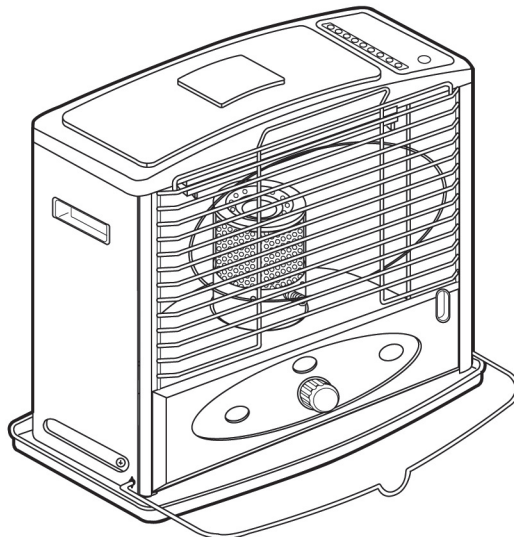

**MODEL : RMC-55R7 / RMC-55R7B**

Before the first use of this heater, please read this OWNER'S MANUAL very carefully. This OWNER'S MANUAL has been designed to instruct you as to the proper manner in which to assemble the heater maintain the heater, store the heater, and most importantly, how to operate the heater in a safe and efficient manner. Please keep this manual for future reference.

**GHP Group, Inc.,  
Niles, IL 60714-3302, USA  
TELEPHONE : 1-877-447-4768**

# CAUTIONS

## - SAFETY GUIDE -

### **1 WARNING!! RISK OF EXPLOSION / RISK OF FIRE**

- ! **NEVER** use any fuel other than water-clear 1-K kerosene or red dyed 1-K kerosene.
- ! **NEVER** use fuel such as gasoline, benzene, paint thinners or other oil compounds in this heater.
- ! **NEVER** refill heater fuel tank when heater is operating or still hot.
- ! **NEVER** use heater in areas where flammable vapors or gases may be present.
- ! **NEVER** fill heater fuel tank in living space; fill tank outdoors.
- ! **NEVER** store or transport kerosene in other than a metal or plastic container that is (1) acceptable for kerosene, (2) non-red in color, and (3) clearly marked "Kerosene." **NEVER** store kerosene in the living space; kerosene should be stored in a well ventilated place outside the living area.

! The unit is **EXTREMELY HOT** while in operation. Due to high surface temperatures, keep children, clothing, furniture, and other combustible objects at least 36" away from top and front area.

### **! RISK OF INDOOR AIR POLLUTION**

**USE HEATER ONLY IN WELL VENTILATED AREAS.** People with breathing problems should consult a physician before using the heater. In a house of typical construction, that is, one that is not of unusually tight construction due to heavy insulation and tight seals against air infiltration, an adequate supply of air for combustion and ventilation is provided through infiltration; however, if the heater is used in a small room where less than 200 cubic feet (5.7 m<sup>3</sup>) of air space is provided for each 1,000 BTU per hour of heater rating (considering the maximum burner adjustment), the door(s) to adjacent room(s) should be kept open or the window to the outside should be opened at least 1 inch (25.4 mm) to guard against potential buildup of indoor air pollution. **DO NOT** use the heater in a bathroom or any other small room with the door closed.

- ! **NEVER** use heater to cook or boil water. **NEVER** not use as a cooking appliance.
- ! **NEVER** use gasoline in this heater. (RISK OF FIRE)
- ! **NEVER** remove the cartridge tank when the heater is operating or when the heater is hot. **NEVER** use the cartridge tank to transport or store kerosene or any other flammable liquids.

Occasionally during normal operation you will hear the sound of fuel draining from the cartridge tank

to fill the fuel reservoir area. This is normal for a cartridge tank kerosene heater.

### **2 WARNING!!**

**FAILURE TO INSTALL, MAINTAIN, AND/OR OPERATE THIS KEROSENE HEATER ACCORDING TO MANUFACTURER'S INSTRUCTIONS MAY RESULT IN CONDITIONS WHICH CAN PRODUCE BODILY INJURY AND/OR PROPERTY DAMAGE.**

**NOTE:** The **WARNING** and **IMPORTANT** instructions appearing in this manual are not meant to cover all possible conditions and situations that may occur. It must be understood that common sense, caution, and care are factors which cannot be built into this heater. These factors must be supplied by the person(s) installing maintaining, or operating the kerosene heater.

Always contact your dealer, distributor, service agent, or the manufacturer on any problems or conditions you do not understand.

- ! **NEVER** leave heater operating if you intend to leave the room for any period of time. Always make sure to turn the heater off and inspect it to insure that it is completely extinguished prior to going to bed.
- ! **NEVER** leave heater unattended.
- ! **NEVER** use as a source of heat for drying objects.
- ! **NEVER** place objects on the top plate.

### **3 WARNING!! RISK OF BURNS**

- ! **NEVER** operate the heater without the guard or grille completely attached.

**4 IF POOR QUALITY KEROSENE** is used a rapid accumulation of carbon and tar is likely. This may cause a strong odor and will destroy the wick. Additional heater damage may occur as the wick becomes more difficult to adjust. The use of poor quality fuel could also make the wick very hard to extinguish. Always make sure the fire is out. (See page 7, Extinguishing the Heater.)

**5 ADJUSTMENT OF ROOM TEMPERATURE** can not be changed by adjusting the heater. A kerosene heater is either on or off. There is no temperature adjustment. If heater output is reduced by lowering the wick in any way, improper combustion will occur producing odors and an accumulation of tar and carbon. If your room becomes too hot, open a door or a window or turn off the heater.

# SAVE THESE INSTRUCTIONS FOR FUTURE REFERENCE!!

## CONTENTS OF OWNER'S MANUAL

| <u>ITEM</u>                                     | <u>PAGE</u> | <u>ITEM</u>                                   | <u>PAGE</u> |
|---|-------------|---|-------------|
| CAUTIONS-SAFETY GUIDE                           | 1           | <b>11</b> WICK REPLACEMENT                    | 10~12       |
| <b>1</b> INTRODUCTION                           | 2           | <b>12</b> CHECKING THE IGNITION SYSTEM        | 13          |
| <b>2</b> FEATURES                               | 2           | <b>13</b> WICK ADJUSTER MECHANISM             | 13          |
| <b>3</b> KEROSENE (1-K ONLY)                    | 3           | <b>14</b> AUTOMATIC SAFETY SHUT-OFF DEVICE    | 13          |
| <b>4</b> UNPACKING AND ASSEMBLING<br>THE HEATER | 4           | <b>15</b> LONG TERM STORAGE OF YOUR<br>HEATER | 14          |
| <b>5</b> FUELING YOUR HEATER                    | 5           | <b>16</b> SPECIAL SAFETY PRECAUTIONS          | 15          |
| <b>6</b> AUTOMATIC IGNITION SYSTEM              | 6           | <b>17</b> TROUBLE SHOOTING GUIDE              | 16          |
| <b>7</b> ADJUSTING THE WICK                     | 7           | <b>18</b> PARTS LIST                          | 17          |
| <b>8</b> EXTINGUISHING THE HEATER               | 7           | <b>19</b> EXPLODED PARTS DRAWING              | 17          |
| <b>9</b> WICK MAINTENANCE                       | 9           | <b>20</b> SPECIFICATIONS                      | 17          |
| <b>10</b> CARBON REMOVAL / DRY BURNING          | 9           |   |             |

### **1** INTRODUCTION

Please read this OWNER'S MANUAL carefully. It will show you how to assemble, maintain, and operate the heater safely and efficiently to obtain full benefit from its many built-in features.

### **2** FEATURES

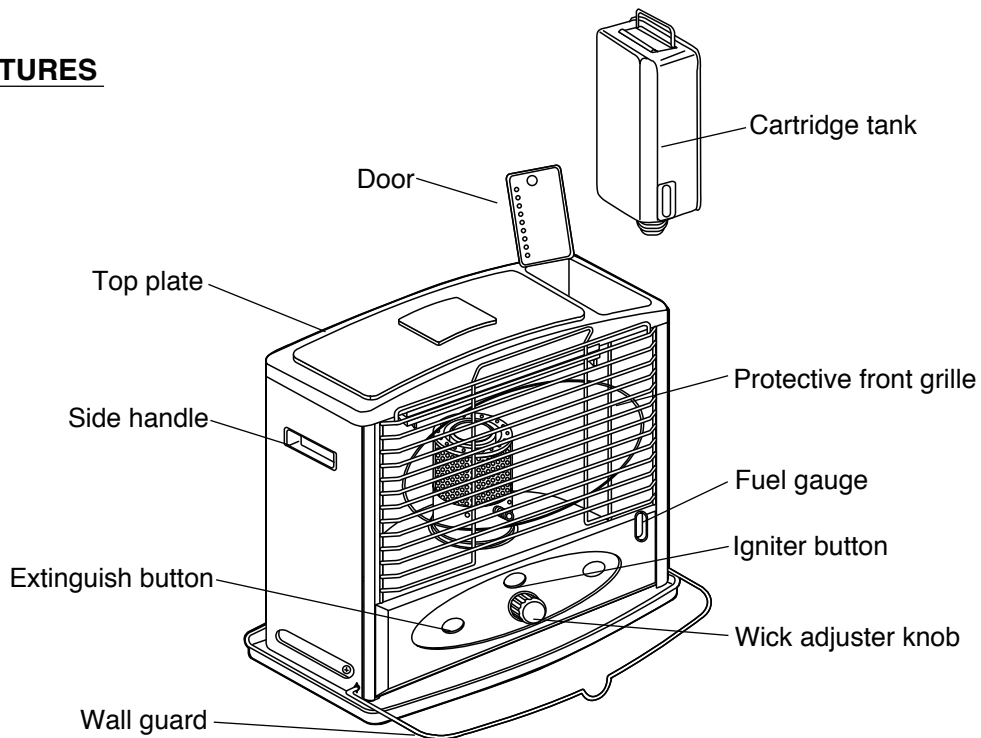

Fig. 1

### **③ KEROSENE (1- K Only)**

It is **EXTREMELY IMPORTANT** to the operation of this heater that you use the proper grade of kerosene. The proper grade of kerosene is identified as **1-K Kerosene**. **DO NOT OPERATE THIS HEATER WITH ANY FUEL OTHER THAN 1-K KEROSENE!** 1-K Kerosene has been refined to virtually eliminate contaminants such as sulphur, which can cause a rotten egg odor during operation of the heater.

**KEROSENE SHOULD ONLY BE STORED IN A BLUE CONTAINER THAT IS CLEARLY MARKED "KEROSENE". NEVER STORE KEROSENE IN A RED CONTAINER.** Red containers are associated with gasoline.

**NEVER** store kerosene in the living space. Kerosene should be stored in a well ventilated place outside the living area.

**NEVER** use any fuel other than water-clear 1-K kerosene or red dyed 1-K kerosene.

**NEVER** use fuel such as gasoline, benzene, alcohol, white gas, camp stove fuel, paint thinners, or other oil compounds in this heater. These are volatile fuels that can cause explosion or uncontrolled flames.

The best way to purchase kerosene is in a pre-packaged, metal or plastic, blue colored container.

The second choice would be to buy it from a dealer who stores it in a 55 gallon drum. The third choice is to buy kerosene from a dealer who stores it in a large underground (or above ground) tank. Kerosene that is contaminated with even a small amount of water will prevent a kerosene heater from functioning properly. As you move from the first choice in purchasing kerosene (pre-packaged container) to the third choice (large storage tank), the likelihood of water being present from condensation increases.

If you purchase kerosene in bulk, know your dealer.

It is normal for a kerosene heater to give off a slight odor upon start-up and shut-down.

After 5-10 minutes of operation, the heater should have reached its normal operating temperature and any odor should be very slight.

**NEVER** store kerosene in direct sunlight or near a source of heat.

**NEVER** use kerosene that has been stored from one season to the next.

Kerosene deteriorates over time. **"OLD KEROSENE" WILL NOT BURN PROPERLY IN THIS HEATER.**

A variety of problems can result from using poor quality kerosene --- smoke, odor, low flame, difficult ignition, difficult shut-down, flame flickers and dies, excessive burning down of the wick, reduced wick life, wick adjuster sticking, excessive deposits on the wick, etc.. If you encounter any of the problems listed above, check your kerosene. If you discover that the kerosene is the problem, get a fresh supply of **WATER-CLEAR 1-K KEROSENE OR RED DYED 1-K KEROSENE** before using your heater again.

#### **4 UNPACKING AND ASSEMBLING THE HEATER**

1. REMOVE THE HEATER AND ALL PACKING MATERIALS FROM THE BOX.(Fig. 2)

**NOTE:** Save the shipping carton and packing materials for future storage.

2. Open the grille from the right hand side, by pulling up on the lower right hand corner. Remove the protective packing materials from the burner. To close grille, slide top bar into slot in housing and lower bottom bar into slot.

3. Open the cartridge tank cover on top of heater and remove the styrofoam protecting the top of the cartridge tank and the cardboard protecting the bottom of the cartridge tank.

4. Keep all packing materials in the carton box.

5. Place the wall guard in the down position. **Never** operate the heater unless the wall guard is in place.

6. INSTALLING BATTERIES(Fig.3)

- The battery holder is located on the back of the heater.
- Insert two(2) "D" cell batteries (supplied with this heater) according to the plus (+) and minus(-) markings inside of the holder.
- Remove dead batteries at once and dispose of them properly. Remove batteries when not in use or when heater is being stored.

7. POSITION THE BURNER (Fig. 4)

- Position the burner on the wick adjuster.
- To confirm proper placement of the burner, grab the burner knob and rotate the burner back and forth three or four times until burner sets properly on the wick adjuster.

8. TEST THE AUTOMATIC SAFETY SHUT-OFF DEVICE

- Turn the wick adjuster clockwise to turn the wick all the way up.
- Press the extinguish button. The wick should drop down to the lowest level.
- To test if the wick has dropped to the lowest level, try to turn the wick down further with the wick adjuster knob, by turning it counter clockwise. If the wick cannot be turned down any further, the automatic safety shut-off device is functioning properly. Do not operate the heater if the automatic safety shut-off device is not functioning properly.

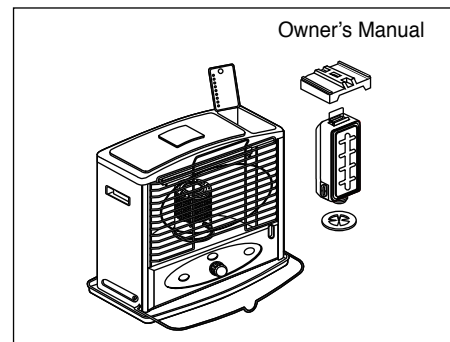

Fig. 2

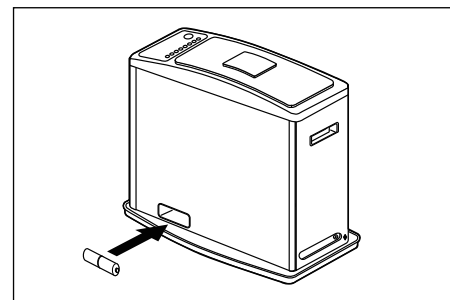

Fig. 3

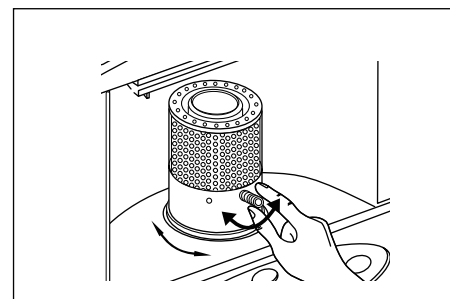

Fig. 4

## 5 FUELING YOUR HEATER

**NOTE :** See section 3, page 3 on **KEROSENE** for instructions on the proper grade of kerosene to use with this heater.

**CAUTION :** NEVER REMOVE THE CARTRIDGE TANK FROM THIS HEATER WHILE THE HEATER IS OPERATING OR WHILE THE HEATER IS STILL HOT. EXTINGUISH THE HEATER AND VERIFY THAT THE HEATER IS COOL TO THE TOUCH BEFORE REFUELING THE HEATER. NEVER REFILL THE CARTRIDGE FUEL TANK WHEN THE HEATER IS OPERATING OR STILL HOT.

**NEVER FILL THE HEATER'S CARTRIDGE FUEL TANK IN THE LIVING SPACE; FILL THE CARTRIDGE FUEL TANK OUTDOORS.**

Before fueling the heater, take the removable cartridge fuel tank, the kerosene, and the manual siphon pump outdoors. To use the manual siphon pump, tighten the cap on the top of the siphon, place the straight tube into the kerosene container, and insert the flexible tube into the opening of the cartridge tank (see Fig. 5A/5B). By squeezing the bulb of the siphon pump, fuel will be transferred from the kerosene container into the heater. Carefully watch the fuel gauge on the cartridge tank so that you will know when the tank is getting full. When you approach the full mark, loosen the cap on top of the siphon pump. This will stop the flow of kerosene. **DO NOT OVERFILL THE CARTRIDGE TANK.** Allow the siphon pump to drain thoroughly before you remove it from the cartridge tank and the kerosene container.

Make sure that you securely replace the fuel tank cap on the cartridge tank and on the kerosene container. Thoroughly clean up any spilled kerosene.

Insert the cartridge tank back into the kerosene heater with the fuel gauge facing toward the front of the heater. (If the cartridge tank is not inserted properly into the heater, the door on the cartridge tank will not close.)

**NOTE:** Refill the cartridge fuel tank before the tank is completely empty (see Fig 6). **DO NOT** refill when the heater is operating or still hot.

**IMPORTANT NOTICE REGARDING FIRST FUELING OF HEATER;**

When first using your heater, make sure that you allow a **minimum of 60 minutes** (carefully check the time) after filling the tank before you attempt to light the heater. This allows time for the wick to become saturated.

**IMPORTANT NOTICE REGARDING FIRST IGNITION OF HEATER;**

The first time you light the heater, it should be done **outdoors**. This allows the oils, etc. used in manufacturing the heater to burn off outside, rather than in your home.

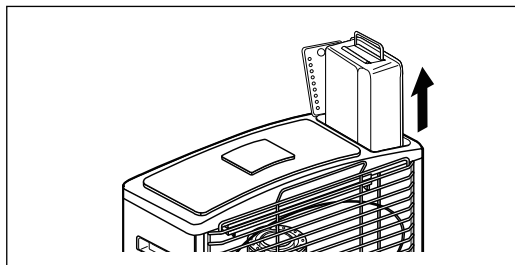

Fig. 5A

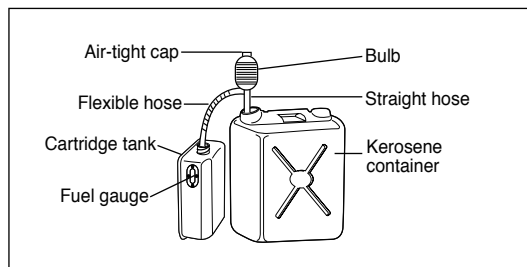
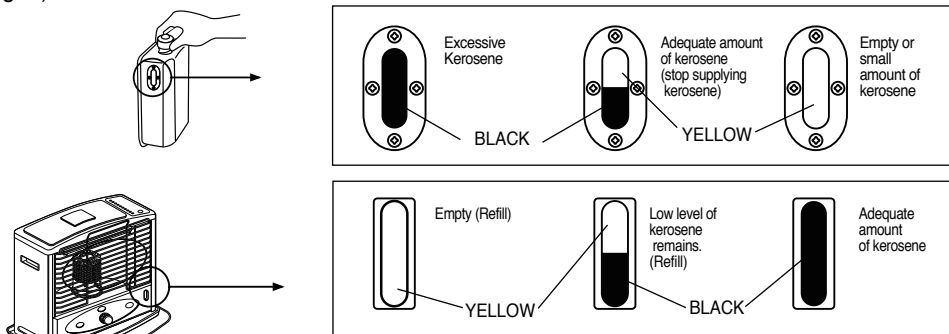

Fig. 5B

**NOTE:** Extinguish the kerosene heater and refill the tank before the fuel reaches the bottom of the cartridge tank. (Fig 6.)



## **6** AUTOMATIC IGNITION SYSTEM

For safety and convenience, this heater features an automatic ignition system.

2 "D" cell batteries, included with the heater, provide the power for the igniter which lights the wick once it has been raised to its maximum height.

When the heater is fueled for the first time, allow a **minimum of 60 minutes** after filling the heater for the wick to absorb kerosene before you attempt to light the heater. Also, the first time you light the heater, it should be done **outdoors** to allow the oils, etc, used in manufacturing the heater to burn off outside, rather than in your home.

### **To use the automatic Ignition system:**

- Make sure the batteries have been installed properly.
- Turn the wick adjuster knob clockwise until the wick has been raised to its maximum height.
- Push the ignition button to bring the glowing igniter into contact with the wick. This will cause ignition to occur.
- As soon as you see that the wick has been lit, release the ignition button. This will automatically lower the burn chamber back down over the wick.
- Rotate the burner knob from side to side a few times to make sure that the burner is positioned properly on the wick adjuster.
- Then begin following the steps outlined in "Adjusting the wick" (page. 7)

## **IGNITION VIA MATCH**

If you encounter a problem with the ignition mechanism, or if you have dead batteries, it is possible to light the heater with a match (Fig. 7).

### **The procedure is as follows:**

- Turn the wick adjuster knob clockwise until the wick has been raised to its maximum height.
- Lift the burn chamber by using the burner knob.
- Touch a lighted match to the exposed top edge of the wick.
- Once you see that the wick has been lit, lower the burn chamber back down over the wick.
- Rotate the burner knob from side to side a few times to make sure that the burner is positioned properly on the wick adjuster.
- Then begin following the steps outlined in "Adjusting the wick" (page. 7)

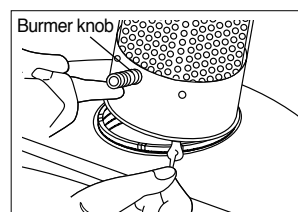

Fig. 7

**CAUTION :** Make sure that you do not leave the match, or any portion of it (match head, etc.) in the burner area. Debris left from the match can cause an uneven alignment of the burner and may result in smoke, incomplete combustion, odor, or fire.

**NOTE :** Once you have extinguished the heater, wait at least 10 minutes before reigniting the wick. Failure to do this will result in a very strong odor and / or smoke being produced.

**NOTE :** Do not use excessive force when pushing the ignition button. This can cause the igniter to catch the wick and may prevent ignition from occurring. Pushing too lightly on the Ignition button can prevent ignition from occurring by keeping the igniter too far from the wick. As Fig. 10 (Page 9) shows, the optimal distance between the igniter and the wick is 1/64- 1/32 inch (0.5 to 1mm). If it is difficult to ignite the heater, the filament on the igniter might be bent, broken or misshaped.



## **7** ADJUSTING THE WICK

After lighting the heater, it is important to check the heater flame within the first 5-7 minutes of operation. After 5-7 minutes of operation, you should use the wick adjuster knob to obtain the proper flame height (see Fig 8). **IF THE FLAME IS TOO YELLOW, TURN THE WICK ADJUSTER KNOB DOWN SLIGHTLY UNTIL YOU GET THE YELLOW FLAME INDICATED IN FIG.8. IF THERE IS NO FLAME, OR A VERY LOW FLAME, TURN THE WICK ADJUSTER KNOB UP SLIGHTLY UNTIL YOU GET THE YELLOW FLAME INDICATED IN FIG.8.**

**VERY FINE ADJUSTMENTS TO THE FLAME CAN BE MADE BY GRABBING THE BURNER KNOB AND MOVING THE BURNER FROM SIDE TO SIDE UNTIL THE YELLOW FLAME IS EVENLY DISTRIBUTED.**

**CAUTION :** Do not grab the burner knob once the heater has reached normal operating temperature and the flame has stabilized. The burner knob is very hot during operation.

As you continue to operate the heater, the temperature of the heater and the temperature of the room will continue to change. As the heater warms up, the kerosene in the tank will vaporize faster, and this could require adjusting the wick down in order to maintain the proper flame. **THE FLAME MAY NEED TO BE ADJUSTED DURING THE TIME THE HEATER IS BEING OPERATED.** Therefore, it is necessary to continue to monitor the flame , and to make adjustments using the wick adjuster knob to keep the proper flame height. It is recommended that the heater be checked every 30 minutes in order to keep the proper adjustment because periodic adjustment is required. **FAILURE TO KEEP THE WICK ADJUSTED PROPERLY WILL RESULT IN SMOKE, ODOR, IMPROPER COMBUSTION, CARBON BUILD-UP, AND A SHORTER WICK LIFE.**

**NOTE :** Occasionally during normal operation you will hear the sound of fuel draining from the cartridge tank to fill the fuel reservoir area. This is normal for a cartridge tank kerosene heater.

**WARNING :** **NEVER** turn the wick adjuster knob lower than the "LOW" setting of the wick adjustment. If you operate the heater below the position where the wick stop engages (the "LOW" setting), smoke, odor, excess emissions, CO (carbon monoxide), and flare-ups can result.

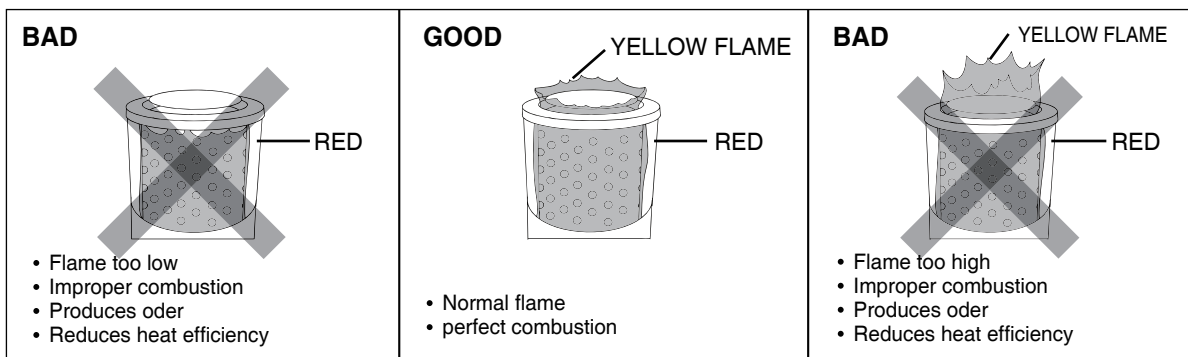

Fig.8

## **8** EXTINGUISHING THE HEATER

To extinguish the heater, push the extinguish button. This should lower the wick to its lowest level. If the wick is not completely lowered, continue to push the extinguish button and turn the wick adjuster knob in a counterclockwise direction (towards "OFF") as far as it will go. After 2 or 3 minutes, lift up the burner assembly using the burner knob and confirm that the heater has extinguished.(see Fig.9.)

**NOTE :** Carbon build-up on the wick may prevent the wick from completely lowering when the extinguish button is pushed. This can result in the flame not extinguishing. If this happens, continue to push the extinguish button and turn the wick adjuster knob in a counterclockwise direction (towards “OFF”) as far as it will go. If this condition exists, inspect the heater and perform the checks and maintenances described on page 9.

**NOTE:** If the heater is jarred or shaken, the automatic safety shut-off device may automatically function.

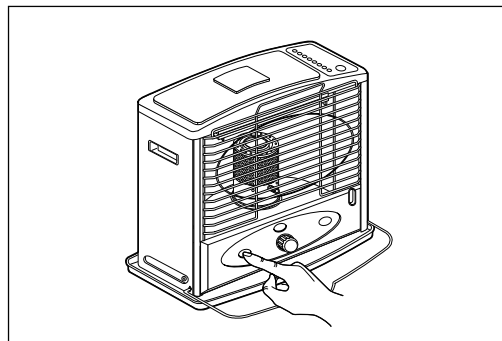

Fig.9

**CAUTION: NEVER** adjust or attempt to disassemble the automatic safety shut-off extinguishing device. This can cause the automatic safety shut-off extinguishing device to not function properly in the case of an emergency.

**CAUTION :** After extinguishing the heater, **allow at least 10 minutes before reigniting the heater.** This allows the heater time to cool off and return to a normal temperature. Failure to allow the 10 minute cooling off period before reigniting the heater will result in the creation of a strong odor and possible flare-up.

**WARNING :** Carbon and tar can build up on the wick after the heater has been in use for a while. This can interfere with the ability of the wick to be lowered into the body of the heater, and can result in the flame not extinguishing completely. It is the responsibility of the owner to inspect the wick, to maintain proper position of the wick, and to replace the wick when necessary in order to prevent the build up of carbon and tar from creating a dangerous situation where the heater does not fully extinguish.

## DAILY CHECK AND MAINTENANCE PROCEDURE

It is important to perform the following check and maintenance procedure on a daily basis during the heating season.

**WARNING:** In performing the check and maintenance procedure,

**NEVER ATTEMPT TO REPAIR THE FOLLOWING PARTS:**

- Automatic safety shut-off Device - Do not adjust or attempt to disassemble this important safety device. This is the principal safety mechanism of the heater.
- Do not spill kerosene on the device.
- Fuel Gauge - Do not remove or unfasten the screws that attach the fuel gauge to the tank.
- Do not disassemble the fuel gauge.

- **Inspect the cleanliness of the heater**

Keep the heater clean at all times. Keep the reflective panel free from dust, dirt, oil, grease, etc.. It is not safe to use a dirty kerosene heater. Dirt, dust and spilled kerosene cause unwanted odors.

- **Inspect the cartridge tank**

Lift out the cartridge tank and inspect for dents, cracks, leaks, etc. If damage is present, replace the tank at once. Check the drip tray to see if kerosene is present. This could indicate a leak. Do not use the heater if kerosene is present in the drip tray. Check for rust or foreign materials in the tank or fuel reservoir.

- **Inspect wick adjuster and wick guide cylinder**

Check daily to look for carbon accumulation. If carbon is present, lower the wick and remove the carbon using a flat edge screwdriver. Be careful not to allow any carbon deposits to drop into the heater.

- **Inspect the igniter**

If the automatic ignition system does not work, check the filament on the igniter (see Fig. 10) (page 9) to see if it is broken or misshapen. A small distortion can be fixed with a match stick. If the filament is stretched or broken, replace the igniter with a new one. **NOTE: Remove the batteries before replacing the igniter.** Refer to section "CHECKING THE IGNITION SYSTEM" on page 3 for instructions on how to replace the igniter.

- **Inspect the batteries**

If the igniter filament does not get hot enough to ignite the wick and the igniter filament appears to be normal, replace the batteries. For best results use non-alkaline batteries only.

- **Inspect the wick**

Inspect the wick before each use to see if carbon has accumulated on the wick. If it has, perform the Carbon Removal procedure described on page 9.

Check the height of the wick as described on page 7.

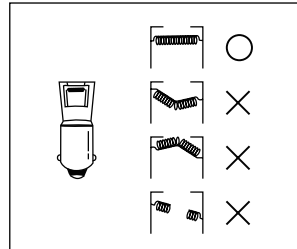
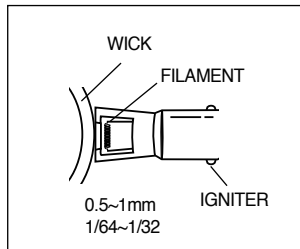

Fig. 10

## 9 WICK MAINTENANCE / DRY BURN

Wick maintenance is necessary to prevent soot production, low heat output and performance issues. Carbon and tar will build up on the top of the wick during regular use of this product. Wick maintenance is required within the first seven (7) days of your first use of the heater and every 2 tankfuls of fuel and/or every week during the heating season. If the wick feels hard and brittle, this indicates that wick maintenance is necessary in order to keep your heater performing accordingly.

### Check Your Wick Often!

- ✓ If the wick is hard to light.
- ✓ If the wick is hard to raise or difficult to adjust by turning the wick adjustment knob.
- ✓ If the wick fails to drop completely when you press the shut-off knob.
- ✓ If the top of the wick is stiff and hard.

Note: Poor fuel or fuel contaminated with water will also turn the wick hard.

## 10 PERFORMING WICK DRY BURN / REMOVING CARBON FROM THE WICK

"Dry burning" your heater will cause a strong odor. For this reason it is best to "dry burn" your heater outdoors on a day that is completely calm and windless. If it's too windy outside you can consider a porch, breezeway or other room with all of the windows open to disperse the strong odor.

Step 1 With your fuel tank nearly empty, burn your heater (without refilling) until the flame starts to burn out then raise the wick to its highest possible setting and leave it there until it burns out completely. Wait 60 minutes, then re-light the wick (with a match if necessary) and allow it to burn out again. Once the heater is cool to the touch, remove the cabinet and brush the top of the wick with an old tooth brush or other stiff bristle brush to remove any remaining ash. A canister type vacuum cleaner may be a useful tool in removing this ash.

Step 2 The first step should remove most carbon and your wick should feel softer to the touch. If any part still feels hard, you can use small pliers to pinch these hard spots and break up the carbon into pieces. After doing this, replace the cabinet, add a small amount of fuel, wait at least one hour and then repeat step 1.

Carry out Carbon Removal / Dry Burning within (7) seven days after your first use of your new heater to reduce carbon build-up on the wick's burning surface, after every two tankfuls of fuel and/or every week during the heating season. Afterwards, dry burn your heater anytime the wick appears to be hard. CHECK YOUR WICK OFTEN! Dry burn your wick and remove all fuel from your heater at the end of the heating season.

**Note: Burn your heater dry, as noted above, weekly during the heating season or necessary thereafter. Check your wick often to see if CARBON REMOVAL / DRY BURNING is necessary. Carbon removal will NOT be effective if your fuel has been contaminated by water or any other liquid. In this case you must clean the fuel tank, replace the wick and soak it for 60 MINUTES in fresh, K-1 Kerosene.**

## **11 WICK REPLACEMENT**

Wick replacement should be performed on a completely cool heater after the cartridge tank has been removed and the remainder of the kerosene in the heater has been burned off.

Use only genuine replacement wick.

Replacement wick number : Glowick 200-B, Kero-World 20401-U, Dura Heat DH-200, Pick-A-Wick-PW27.

Open the tank cover and remove the cartridge tank. Remove the batteries to prevent possible burns. Open the front grille and remove the chimney. Remove the wick adjusting knob by pulling straight out.

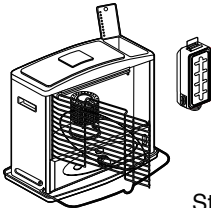

Step 1

Unscrew 5 screws, two from the back and one from the right side and two from the left side of the cabinet.

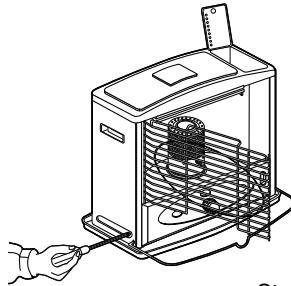

Step 2

Remove the cabinet. By pulling it straight up.

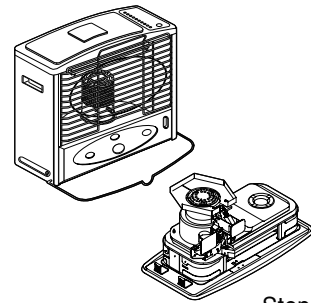

Step 3

Remove the screw on the wind cover.

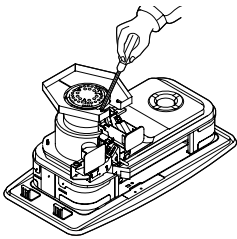

Step 4

Remove the wind cover.

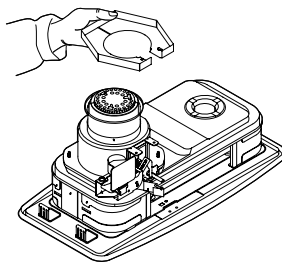

Step 5

Remove the automatic ignition Assembly by unscrewing 2 screws.

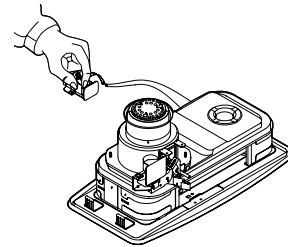

Step 6

Unscrew 4 wing nuts.

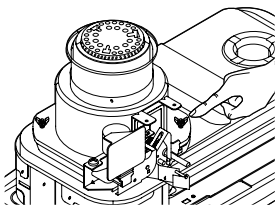

Step 7

Remove the wick adjuster assembly.

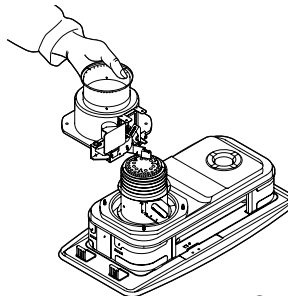

Step 8

Remove the wick from the holder by folding it toward the center loosening it from the sharp metal teeth on the inner surface of the holder, and slide it out.

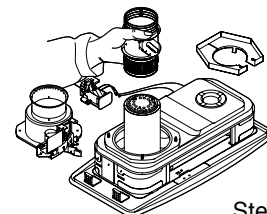

Step 9

Replacement wick has a black line. Fold the new wick and slide it into the holder.

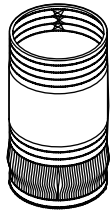

Step 10

The black line on the outside of the wick should match the top edge of the holder. Then press it against the teeth inside the holder to obtain a firm grip.

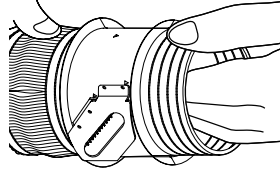

Step 11

Replace the wick and holder in the burner tank. Rotate 90 degrees left and right as well as up and down until the wick slides freely. Check to see that gasket is still in place on the burner tank.

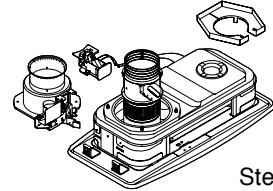

Step 12

It is recommended to reinstall the wick adjusting knob for easier assembling.

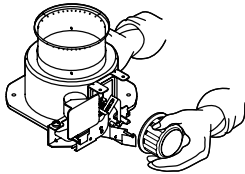

Step 13

Insert the pinion at the other end of the wick control shaft into top portion of the rack of the wick holder. This step can be easily carried out if the wick holder is raised.

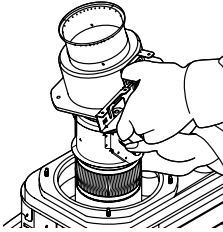

Step 14

Slide the wick adjuster assembly down the draft tube. Position the adjuster shaft to the front of the heater.

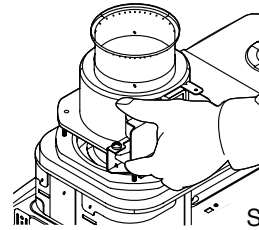

Step 15

Snug 4 wing nuts on the mounting stud, but do not tighten.

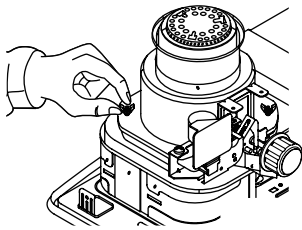

Step 16

Raise the wick to the full "up" position, and evenly tighten wing nuts in several steps.

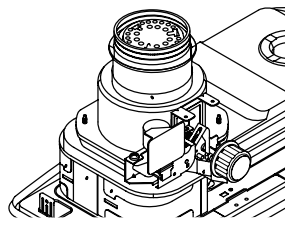

Step 17

Check height of wick. It should be 5/16" above collar.

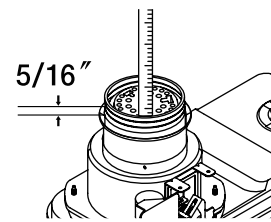

Step 18

Check for correct clearance between wick holder and draft tube. It should be the same all around.

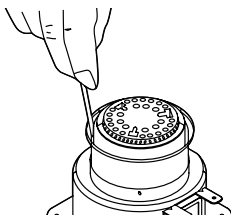

Step 19

Check the function of safety shut-off mechanism by pushing the extinguish button to upset the pendulum.

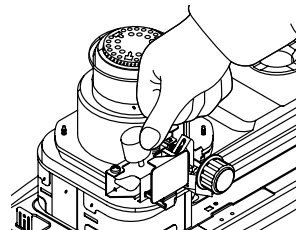

Step 20

Reinstall the automatic ignition assembly.

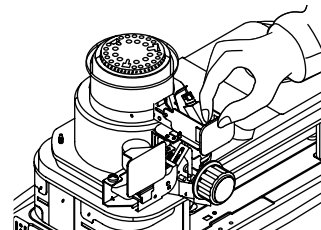

Step 21

Reinstall the wind cover.

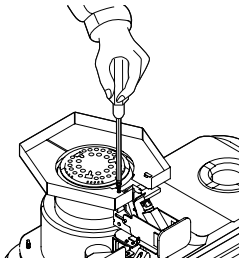

Step 22

Remove the wick adjusting knob once again, if it was reinstalled before.

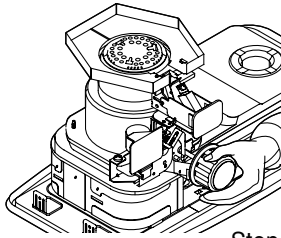

Step 23

Reinstall the cabinet.

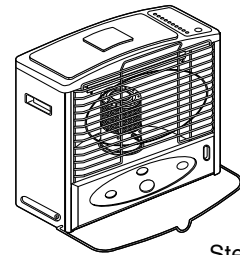

Step 24

Tighten 5 screws on the cabinet

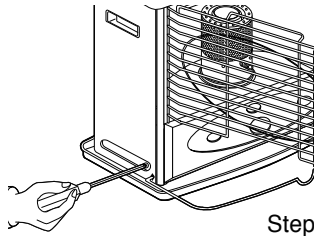

Step 25

Reinstall the chimney and the cartridge tank.

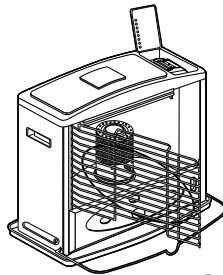

Step 26

Reinstall the wick adjusting knob. Close the front grille.

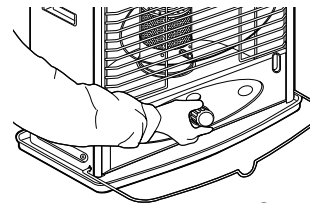

Step 27

Install the batteries in the battery case, and fill the Cartridge tank with clean, pure kerosene. Set the tank into the heater and wait at least 60 minutes for the new wick to fully saturate with kerosene.

## **12 CHECKING THE IGNITION SYSTEM**

If the automatic ignition system fails to operate properly, perform the following checks:

- **BATTERIES** - 2 "D" cell batteries are located at the rear of the heater. Check for proper installation. And / or Replace with new batteries.
- **IGNITE R PLUG** - If the automatic ignition system still doesn't work after replacing the batteries, check the igniter plug. If the glow coil filament is broken, bent, or doesn't glow when engaged via the ignition lever, it must be replaced. **CAUTION: Be sure Igniter plug is 2.5V DC, 1A only.**

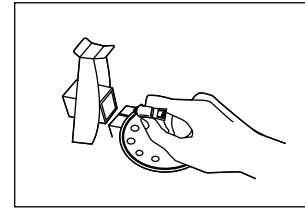

Fig. 11

### **To replace the igniter plug (Fig. 11);**

- Remove the batteries.
- Open the protective grille and remove the burner assembly.
- Push the ignition button to raise the igniter plug.
- Push the igniter plug in and turn in a **counterclockwise** direction to remove.
- Install a new igniter plug (2.5V DC, 1 A only) by pushing it in and turning it in a **clockwise** direction.
- Replace the burner assembly, close the protective grill, and reinstall the batteries.

## **GLASS CYLINDER REPLACEMENT**

Remove speed nuts holding cross pins with a pair of pliers or pry off with a screwdriver. Then pull out cross pins. Replace glass cylinder. In reassembling, make sure that inner and outer cylinders are set in their proper places.

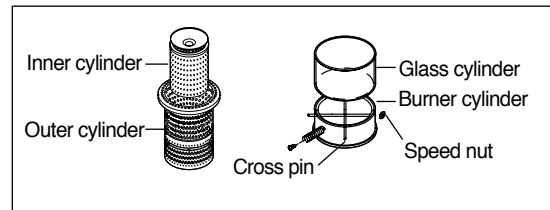

## **13 WICK ADJUSTER MECHANISM**

Turning the wick adjuster knob in a clockwise direction lifts the wick to the top of the wick holder assembly. As the wick is dialed up, the torsion spring located on the wick control shaft is compressed. Raising the wick to the full up position allows the wick to come into contact with the igniter when the ignition knob is depressed. Pressing the extinguish button causes the torsion spring to rapidly lower the wick. You can slow the speed at which the wick is lowered by holding the wick adjuster knob when pressing the manual extinguish button. By slowly releasing the wick adjuster knob, you can slow the speed at which the wick is lowered and reduce the chance of encountering a kerosene odor when extinguishing the heater.

## **14 AUTOMATIC SAFETY SHUT-OFF DEVICE**

This heater is equipped with an automatic safety shut-off device. The purpose of this device is to quickly and efficiently shut off the heater should the heater be jarred or tipped over while in operation. This is the main safety system that is built into the heater, and it functions to prevent the flame from spreading if the heater is knocked over.

The automatic safety shut-off device is built into the mechanism that raises and lowers the wick. It has been designed so that if the pendulum is jarred by a shock of some sort, it retracts a latch from the wick control shaft ratchet, and a torsion spring reacts to drop the wick to its fully lowered position. This rapid lowering of the wick extinguishes the flame. Do not attempt to adjust the torsion spring.

**IMPORTANT NOTICE:** For the automatic safety shut-off device to function properly, the wick must be free of carbon and tar deposits. Regularly performing the "Carbon Removal / Dry burning" procedure described in the "Wick Maintenance" and "Carbon Removal / Dry Burning" sections on page 9 is very important to the proper functioning of this important safety device.

**IMPORTANT NOTICE:** PLEASE CHECK THE AUTOMATIC SAFETY SHUT-OFF DEVICE ONCE A WEEK DURING THE HEATING SEASON TO INSURE THAT IT IS FUNCTIONING PROPERLY.

**IMPORTANT NOTICE:** EVERY TIME THE WICK IS REMOVED OR REPLACED, THE AUTOMATIC SAFETY SHUT-OFF DEVICE MUST BE TESTED TO INSURE THAT IT IS FUNCTIONING PROPERLY.

**TESTING THE AUTOMATIC SAFETY SHUT-OFF DEVICE:** At least once a week during the heating season, it is important to test the safety shut-off device to be sure that it is operating properly. **WITH THE HEATER TURNED OFF,** raise the wick using the wick adjuster knob to the fully raised position. Grabbing the protective grille, give the heater a firm shake. If the automatic safety shut-off device is working properly, you will hear a loud noise as the ratchet is disengaged and the torsion spring drops the wick into the body of the heater. To verify that the wick has been completely lowered, turn the wick adjuster knob in a counterclockwise direction. If the automatic safety shut-off device is functioning properly, the wick will have been completely lowered. If you are able to lower the wick further using the wick adjuster knob, this means that it is time to perform the "Carbon Removal Dry Burning" procedure described on page 9 again.

## **15 LONG TERM STORAGE OF YOUR HEATER**

Carefully following the instructions for storage given below will insure that your heater will operate efficiently and safely next season (Fig. 12/ Fig. 13).

- Using a small amount of kerosene, swirl and rinse the inside of the tank. **NEVER** mix water with the kerosene as it will cause rust inside the tank. Pour the kerosene out making sure that you remove it all.
- With the fuel tank empty, ignite the heater. With the wick at its maximum height, keep the wick burning until it burns out completely (about 1 hour). It is best to do this outside or in an extremely well ventilated area.
- Remove the batteries and the burner assembly. Then, remove the wick adjuster from the fuel reservoir. Dry the Inside of the fuel reservoir completely. If carbon has accumulated on the wick adjuster, remove it. Remove any carbon or soot that is present on the burner assembly.
- Remove the batteries (Fig.12) from the battery case before storing the heater to prevent leakage and corrosion. Remove the 5 cabinet screws and lift off they the cabinet and grille assembly. Remove the burner. Remove the wick adjuster from the fuel reservoir. Thoroughly dry the Inside of the fuel tank. Using a screwdriver and/or a brush, remove any carbon, tar or soot that might have accumulated on the wick adjuster, wick guide or burner.
- After a thorough cleaning, reassemble the heater. It is important when reassembling the wick adjuster to be sure to maintain an equal gap between the wick adjuster and the wick guide cylinder all around. See "Wick Replacement" on page11 for reference. (figure 19)
- Store the heater with the wick in the fully lowered position and the automatic safety shut-off device deactivated.
- Store the heater in the original box with the original packing material and boca also keep the **OWNER'S MANUAL** with the heater. Store in an area that is well ventilated.

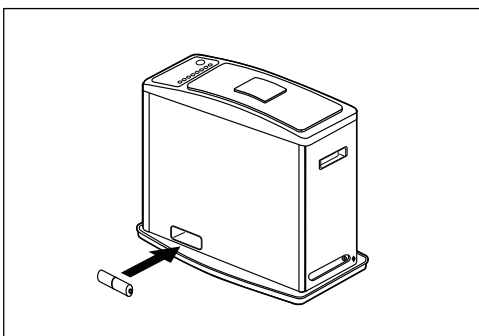

Fig. 12

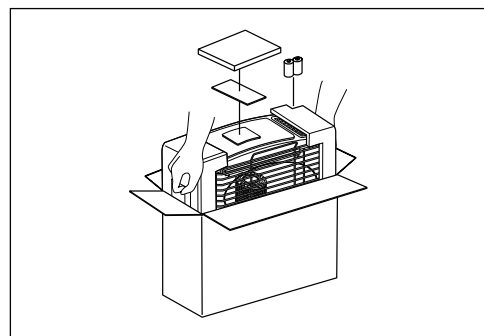

Fig. 13



## **16 SPECIAL SAFETY PRECAUTIONS**

### **Where to use your kerosene heater**

- Only use a kerosene heater on a level surface.
- Do not place a kerosene heater in a traffic areas such as an entrance or exit. Do not use a kerosene heater in a windy area.
- Do not place a kerosene heater under a mantelpiece or a shelf.
- Do not use a kerosene heater in a room where the temperature is more than 86° F (30°C).
- Do not use a kerosene heater near curtains or near any other flammable objects.
- Do not use a kerosene heater in a moving vehicle or in any other unstable environment.
- Never leave the heater unattended while burning.

### **How to use your kerosene heater**

- **Do not try to operate your kerosene heater until you have completely read this owners manual.**
- After igniting the wick according to the instructions in this owner's manual, confirm that the wick is burning in a normal manner. Having the wick raised too high, or lifting the burner can cause abnormal burning. This can be dangerous. The flame may need to be adjusted during the time the heater is being operated (see "Adjusting the Wick", section 7,page 7). Failure to keep the wick adjusted properly will result in smoke, odor, improper combustion, carbon build-up, and a shorter wick life.
- **Use heater only in well ventilated areas.** If there is a shortage of oxygen in the room that it is being used, it can cause improper combustion and can generate carbon monoxide.
- **Never** use heater in areas where flammable vapors or gases may be present.
- **Never** use the heater as a source for drying objects.
- **Never** attempt to carry the heater while it is operating.
- **Never** use the heater to heat or boil water. or use as a cooking appliance.
- **Never** touch any part of the top plate or front grille while the heater is operating. These surfaces are hot.
- **Never leave the heater unattended while burning.** Always make sure to turn the heater off and inspect to insure that it is completely extinguished prior to going to bed.
- If the heater is burning abnormally, and you cannot put out the flame by using the extinguish button,use a fire extinguisher to smother the heater.
- **Never** use any fuel other than water-clear 1-K kerosene or red dyed 1-K kerosene.
- **Never** expose the glass cylinder to water.

### **How to check and maintain your kerosene heater**

- Carefully follow the procedure outlined in the "Daily Check and Maintenance Procedure" in this owner's manual page 8.
- If there is any problem with this heater, have it fixed before operating. Using the heater when a problem exists (even a minor one) can be dangerous.
- Carefully follow the procedure outlined in the "Wick Maintenance" section (section 9, page 9) and the "Carbon Removal / Dry Burning" section (section10, page9) in order to insure that the wick is in proper condition.

## **17 TROUBLE SHOOTING GUIDE**

| <b>TROUBLES</b>  | <b>CORRECTIVE ACTION</b>   |
|--|--|
| <p><b><u>Heater Will Not Light :</u></b></p> <ol style="list-style-type: none"> <li>1. Fuel tank is empty</li> <li>2. Water present in kerosene</li> <li>3. Igniter plug Fails to Glow</li> <li>4. Igniter plug makes contact with side of wick</li> </ol>                     | <ol style="list-style-type: none"> <li>1. Fill tank with <b>water-clear 1-K kerosene or red dyed 1-K kerosene.</b></li> <li>2. Drain tank. Remove wick assembly &amp; replace wick. Reinstall wick assembly. Fill tank with <b>water-clear 1-K kerosene or red dyed 1-K kerosene.</b></li> <li>3. Replace batteries if necessary. Be sure batteries are installed properly. Replace igniter plug. Check for broken or disconnected wire.</li> <li>4. Lower wick using wick adjuster knob until igniter plug makes contact with top of wick.</li> </ol> |
| <p><b><u>Heater Produces Smoke or Odor :</u></b></p> <ol style="list-style-type: none"> <li>1. Flame is too high</li> <li>2. Heater is in an air draft</li> <li>3. Burner is not level</li> <li>4. Carbon or tar built up on wick</li> <li>5. Contaminated kerosene</li> </ol> | <ol style="list-style-type: none"> <li>1. Using wick adjuster knob, lower wick to desired 1/2" flame.</li> <li>2. Move heater out of air draft.</li> <li>3. Using burner knob, rotate burner from side to side until it seats properly over wick.</li> <li>4. Perform "Carbon Removal / Dry Burning" procedure. Replace wick if necessary.</li> <li>5. Drain tank. Remove wick assembly &amp; replace wick. Reinstall wick assembly. Fill tank with <b>water-clear 1-K kerosene or red dyed 1-K kerosene.</b></li> </ol>                               |
| <p><b><u>Flame Flickers or Dies :</u></b></p> <ol style="list-style-type: none"> <li>1. Water present in kerosene</li> <li>2. Carbon or tar built up on wick</li> </ol>  | <ol style="list-style-type: none"> <li>1. Drain tank. Remove wick assembly &amp; replace wick. Reinstall wick assembly. Fill tank with <b>water-clear 1-K kerosene or red dyed 1-K kerosene.</b></li> <li>2. Perform "Carbon Removal / Dry Burning" procedure. Replace wick if necessary.</li> </ol>   |
| <p><b><u>Wick Burning Down Excessively :</u></b></p> <ol style="list-style-type: none"> <li>1. Dangerous, volatile fuel mixed with kerosene (gasoline, benzene, alcohol, white gas, paint thinner, camp, stove fuel, oil compound)</li> </ol>                                  | <ol style="list-style-type: none"> <li>1. Drain and clean tank <ul style="list-style-type: none"> <li>— Remove and replace wick</li> <li>— Fill tank with <b>water-clear 1-K kerosene or red dyed 1-K kerosene.</b></li> </ul> </li> </ol>   |
| <p><b><u>Wick Adjuster Sticks :</u></b></p> <ol style="list-style-type: none"> <li>1. Water present in kerosene</li> <li>2. Carbon or tar built up</li> </ol>  | <ol style="list-style-type: none"> <li>1. Drain tank. Remove wick assembly &amp; replace wick. Reinstall wick assembly. Fill tank with <b>water-clear 1-K kerosene or red dyed 1-K kerosene.</b></li> <li>2. Perform "Carbon Removal / Dry Burning" procedure. Replace wick if necessary.</li> </ol>   |
| <p><b><u>Heater is enveloped in flames :</u></b></p>   | <ul style="list-style-type: none"> <li>– Call Fire Department.</li> <li>– Exit quickly and warn others.</li> <li>– DO NOT: Move heater, try to smother fire, or put water on fire.</li> </ul>  |

## 18 PARTS LIST

| DRAWING NUMBER | DESCRIPTION                             | PART NUMBER        |
|----------------|---|--------------------|
| 1              | FUEL CAP                                | WS-CT01R           |
| 2              | HINGE SPRING                            | WS-CT02R           |
| 3              | DOOR(RMC-55R7)                          | WS-CT03R           |
| 3-1            | DOOR(RMC-55R7B)                         | WS-CT03RB          |
| 4              | TOP PLATE(RMC-55R7)                     | WS-CT04R           |
| 4-1            | TOP PLATE(RMC-55R7B)                    | WS-CT04RB          |
| 5              | CARTRIDGE TANK<br>BAFFLE ASS'Y          | WS-CT05R-1         |
| 6              | VERTICAL REFLECTOR                      | WS-CT06R           |
| 7              | BOTTOM REFLECTOR                        | WS-CT07R           |
| 8              | CABINET HANDLE(RMC-55R7)                | WS-CT08R           |
| 8-1            | CABINET HANDLE(RMC-55R7B)               | WS-CT08RB          |
| 9              | CABINET(RMC-55R7)                       | WS-CT09R           |
| 9-1            | CABINET(RMC-55R7B)                      | WS-CT09RB          |
| 10             | FUEL INDICATOR WINDOW(RMC-55R7)         | WS-CT10R           |
| 10-1           | FUEL INDICATOR WINDOW(RMC-55R7B)        | WS-CT10RB          |
| 11             | TOP FRONT PANEL                         | WS-CT37R           |
| 12             | FRONT PANEL(RMC-55R7)                   | WS-CT12R           |
| 12-1           | FRONT PANEL(RMC-55R7B)                  | WS-CT12RB          |
| 13             | WICK HOLDER GASKET                      | WS-CT13R           |
| 14             | BATTERY CASE ASS'Y(RMC-55R7)            | WS-CT14R           |
| 14-1           | BATTERY CASE ASS'Y(RMC-55R7B)           | WS-CT14RB          |
| 15             | TANK HOLDER                             | WS-CT15R           |
| 16             | BURNER TANK ASS'Y                       | WS-CT16R           |
| 17             | DRIP TRAY ASS'Y                         | WS-CT17R-1         |
| 18             | BURNER ASS'Y                            | WS-CT18R           |
| 19             | GRILLE                                  | WS-CT19R           |
| 20             | WIND COVER                              | WS-CT20R           |
| 21             | IGNITION COIL                           | WS-CT21R           |
| 22             | SAFETY SHUTIOFF DEVICE(RMC-55R7)        | See 24             |
| 22-1           | SAFETY SHUTIOFF DEVICE(RMC-55R7B)       | See 24-1           |
| 23             | IGNITER ASS'Y                           | WS-CT23R-1         |
| 24             | WICK ADJUSTER (RMC-55R7)<br>(COMPLETE)  | 2123-0030-00       |
| 24-1           | WICK ADJUSTER (RMC-55R7B)<br>(COMPLETE) | 2123-0031-00       |
| 25             | WICK ADJUSTER KNOB(RMC-55R7)            | WS-CT25R           |
| 25-1           | WICK ADJUSTER KNOB(RMC-55R7B)           | WS-CT25RB          |
| 26             | WICK HOLDER                             | WS-CT26R           |
| 27             | WICK                                    | See Specs<br>Below |
| 28             | WING NUT                                | WS-CT28R           |
| 29             | TOP DRAFT TUBE A                        | WS-CT29R           |
| 30             | GLASS CYLINDER                          | WS-CT30R           |
| 31             | BOTTOM INSULATOR ASS'Y                  | WS-CT31R           |
| 32             | TOP INSULATOR                           | WS-CT32R           |
| 33             | WALL GUARD                              | WS-CT33R-1         |
| 34             | CARTRIDGE TANK ASS'Y                    | WS-CT34R           |

REPAIR OF DAMAGED OR LEAKING  
CARTRIDGE TANK ASSEMBLY MUST  
BE DONE BY A FACTORY  
AUTHORIZED SERVICE STATION.

## 19 EXPLODED PARTS DRAWING

NOTE: SPECIFY MODEL NUMBER AND  
PART NUMBER WHEN ORDERING PARTS.

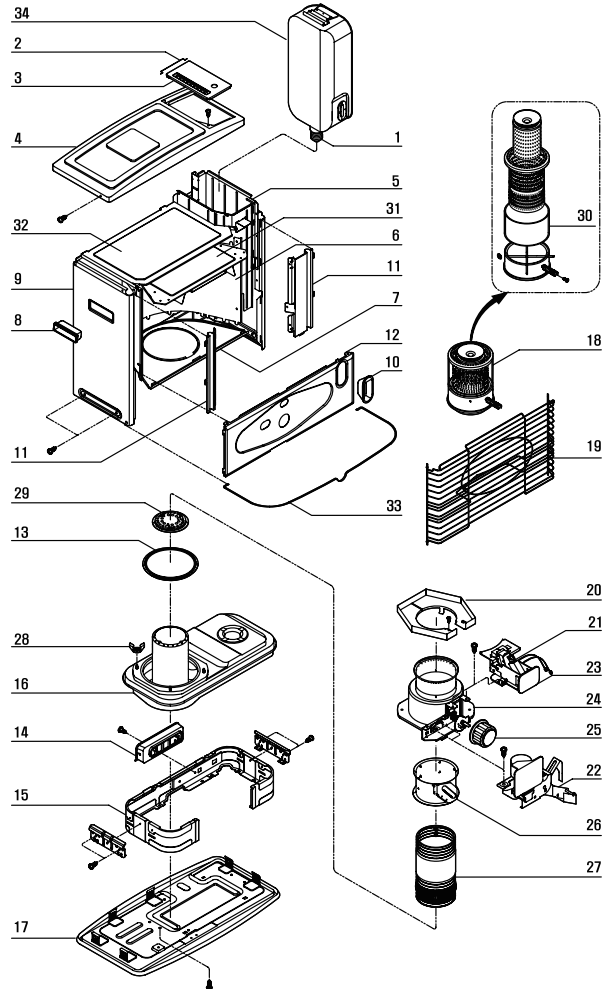

## 20 SPECIFICATIONS

|                            |  |             |
|----------------------------|--|-------------|
| Model No.                  | RMC-55R7/RMC-55R7B   |             |
| Type of Heater             | Radiant Reflection   |             |
| Heat Output                | Max. 10,000 BTU/hr   |             |
| Fuel Tank                  | Cartridge  |             |
| Tank Capacity              | 1.0 U.S. Gallon  |             |
| Continuous Combustion Time | Approx. 11-14 hr.  |             |
| Max. Fuel Combustion       | 0.07 U.S. gallons/hr   |             |
| Ignition Method            | Battery-D Cell × 2   |             |
| Dimensions                 | Height   | 19.3 inches |
|                            | Width  | 22.3 inches |
|                            | Depth  | 11.9 inches |
| Max. Wick Height           | 5/16" (8mm)  |             |
| Replacement Wick Number    | Pick-A-Wick-PW27, Kero-World<br>20401-U, Dura Heat DH-200<br>Glowick 200-B |             |
| U.L. Listed                | Yes  |             |

# Warranty

## LIMITED WARRANTY:

This limited warranty is extended to the original retail purchaser of this Forced Air/Convection/Radiant Heater and warrants against any defect in materials and workmanship for a period of one (1) year from the date of retail sale. GHP Group, Inc., at its option, will either provide replacement parts or replace or repair the unit, when properly returned to the retailer where purchased or one of our service centers as directed by GHP Group, Inc., within one (1) year of retail purchase. (Shipping costs, labour costs, etc. are the responsibility of the purchaser.)

## DUTIES OF THE OWNER:

This heating appliance must be operated in accordance with the written instructions furnished with this heater. This warranty shall not excuse the owner from properly maintaining this heater in accordance with the written instructions furnished with this heater. A bill of sale, canceled check or payment record must be kept to verify purchase date and establish warranty period. Original carton should be kept in case of warranty return of unit.

## WHAT IS NOT COVERED:

1. Damage resulting from use of improper fuel.
2. Damage caused by misuse or use contrary to the owners manual and safety guidelines.
3. Damage caused by a lack of normal maintenance.
4. Fuses
5. Use of non-standard parts or accessories.
6. Damage caused in transit. Freight charges on warranty parts or heaters to and from the factory shall be the responsibility of the owner.

This warranty does not imply or assume any responsibility for consequential damages that may result from the use, misuse, or the lack of routine maintenance of this heating appliance. A cleaning fee and the cost of parts may be charged for appliance failures resulting from lack of maintenance. This warranty does not cover claims which do not involve defective workmanship or materials. **FAILURE TO PERFORM GENERAL MAINTENANCE (INCLUDING CLEANING) WILL VOID THIS WARRANTY.**

THIS LIMITED WARRANTY IS GIVEN TO THE PURCHASER IN LIEU OF ALL OTHER WARRANTIES, EXPRESSED OR IMPLIED, INCLUDING BUT NOT LIMITED TO THE WARRANTIES OF MERCHANTABILITY OF FITNESS FOR A PARTICULAR PURPOSE, THE REMEDY PROVIDED IN THIS WARRANTY IS EXCLUSIVE AND IS GRANTED IN LIEU OF ALL OTHER REMEDIES. IN NO EVENT WILL GHP GROUP, INC. BE LIABLE FOR INCIDENTAL OR CONSEQUENTIAL DAMAGES.

Some states do not allow limitations on how long an implied warranty lasts, so the above limitation may not apply to you. Some states do not allow the exclusion or limitation of incidental or consequential damages so the above limitation or exclusion may not apply to you.

## CLAIMS HANDLED AS FOLLOWS:

1. Contact your retailer and explain the problem.
2. If the retailer is unable to resolve the problem, contact our Customer Service Dept. detailing the heater model, the problem, and proof of date of purchase.
3. A representative will contact you. DO NOT RETURN THE HEATER TO GHP GROUP, INC. unless instructed by our Representative. This warranty gives you specific legal rights and you may also have other rights which vary from state to state.

TO REGISTER THE WARRANTY ON YOUR HEATER, PLEASE FILL OUT THIS CARD COMPLETELY  
AND MAIL WITHIN 14 DAYS FROM DATE OF PURCHASE OR REGISTER ON-LINE AT [www.ghpgroupinc.com](http://www.ghpgroupinc.com)

NAME: \_\_\_\_\_ PHONE: (     ) \_\_\_\_\_ EMAIL: \_\_\_\_\_  
ADDRESS: \_\_\_\_\_ CITY: \_\_\_\_\_ STATE: \_\_\_\_\_ ZIP: \_\_\_\_\_  
MODEL: \_\_\_\_\_ SERIAL #: \_\_\_\_\_ DATE PURCHASED: \_\_\_\_\_  
DEALER PURCHASED FROM: \_\_\_\_\_ TYPE OF STORE: \_\_\_\_\_  
CITY & STATE WHERE PURCHASED: \_\_\_\_\_ PRICE PAID: \_\_\_\_\_

**Please Take a Minute To Give Us Your Answers To The Following Questions.**

**All Responses Are Used Solely For Market Research And Are Held In Strict Confidence.**

Who primarily decided this purchase?  Male  Female  18-24  25-39  40-59  60 and over

Purpose of Purchase? \_\_\_\_\_

Do you own any other portable heaters?  Yes  No If yes, type \_\_\_\_\_ brand \_\_\_\_\_

How do you intend to use your new heater?  Construction Site  Farm  Warehouse/Commercial  Garage/Outbuilding  Other

How did you become aware of this heater?  In-Store Display  Newspaper Ad  Magazine Ad  Friend/Relative

TV Commercial  Store Salesperson  Other \_\_\_\_\_

What made you select this heater?  Style  Size/Portability  Price  Package  Brand  Other \_\_\_\_\_

Do you:  own  rent Would you recommend this heater to a friend?  Yes  No

Please give us your comments: \_\_\_\_\_

THANK YOU FOR COMPLETING THIS FORM!

Information will be held confidential.

## **WARRANTY REGISTRATION**

**IMPORTANT: We urge you to fill out your warranty registration card within fourteen (14) days of date of purchase. You can also register your warranty on the internet at [www.ghpgroupinc.com](http://www.ghpgroupinc.com). Complete the entire serial number. Retain this portion of the card for your records.**



GHP Group, Inc.  
6440 W Howard St  
Niles, IL 60714-3302

Tel: (877) 447-4768  
[www.ghpgroupinc.com](http://www.ghpgroupinc.com)

**SAVE THIS CARD!**

Place  
Postage  
Stamp  
Here

GHP Group, Inc.  
6440 W Howard St  
Niles, IL 60714-3302