

This Owner's Manual is provided and hosted by [Appliance Factory Parts](#).



# DYNA-GLO WK95C6C-1 Owner's Manual

[Shop genuine replacement parts for DYNA-GLO  
WK95C6C-1](#)



[Find Your DYNA-GLO HVAC Parts - Select From 146 Models](#)

----- Manual continues below -----

*PORTABLE  
KEROSENE-HEATER*  
**“OWNER’S MANUAL”**



**MODEL : WK95C6C**



Before the first use of this heater, please read this OWNER'S MANUAL very carefully. This OWNER'S MANUAL has been designed to instruct you as to the proper manner in which to assemble the heater, maintain the heater, store the heater, and most importantly, how to operate the heater in a safe and efficient manner, please keep this manual for future reference.

**GHP Group, Inc.,  
Niles, IL 60714-3302, USA  
TELEPHONE : 1-877-447-4768**

**NEVER LEAVE THE HEATER  
UNATTENDED WHILE BURNING!**

# CAUTIONS - SAFETY GUIDE -

## **1 WARNING!! RISK OF EXPLOSION / RISK OF FIRE**

- ! **NEVER** use any fuel other than water-clear 1-K kerosene or red dyed 1-K kerosene.
- ! **NEVER** use fuel such as gasoline, benzene, paint thinners or other oil compounds in this heater.
- ! **NEVER** refill heater fuel tank when heater is operating or still hot.
- ! **NEVER** use heater in areas where flammable vapors or gases may be present.
- ! **NEVER** fill heater fuel tank in living space; fill tank outdoors.
- ! **NEVER** store or transport kerosene in other than a metal or plastic container that is (1) acceptable for kerosene, (2) non-red in color, and (3) clearly marked "Kerosene". **NEVER** store kerosene in the living space; kerosene should be stored in a well ventilated place outside the living area.

! The unit is **EXTREMELY HOT** while in operation. Due to high surface temperatures, keep children, clothing, furniture, and other combustible objects at least 36" away from top and front area.

### **! RISK OF INDOOR AIR POLLUTION**

#### **USE HEATER ONLY IN WELL VENTILATED**

**AREAS.** People with breathing problems should consult a physician before using the heater. In a house of typical construction, that is, one that is not of unusually tight construction due to heavy insulation and tight seals against air infiltration, an adequate supply of air for combustion and ventilation is provided through infiltration; however, if the heater is used in a small room where less than 200 cubic feet (5.7 m of air space is provided for each 1,000 BTU per hour of heater rating (considering the maximum burner adjustment), the door(s) to adjacent room(s) should be kept open or the window to the outside should be opened at least 1 inch (25.4 mm) to guard against potential buildup of indoor air pollution. **DO NOT** use the heater in a bathroom or any other small room with the door closed.

! **NEVER** use heater to heat or boil water or use as a cooking appliance.

## **2 WARNING!!**

**FAILURE TO INSTALL, MAINTAIN, AND/OR**

**OPERATE THIS KEROSENE HEATER ACCORDING TO MANUFACTURER'S INSTRUCTIONS MAY RESULT IN CONDITIONS WHICH CAN PRODUCE BODILY INJURY AND/OR PROPERTY DAMAGE.**

**NOTE:** The **WARNING** and **IMPORTANT** instructions appearing in this manual are not meant to cover all possible conditions and situations that may occur. It must be understood that common sense, caution, and carefulness are factors which cannot be built into this heater. These factors must be supplied by the person(s) installing, maintaining, or operating the kerosene heater.

Always contact your dealer, distributor, service agent, or the manufacturer on any problems or conditions you do not understand.

! **NEVER** leave heater operating if you intend to leave for any period of time. Always make sure to turn heater off and inspect to insure that it is completely extinguished prior to going to bed.

! **NEVER** leave heater unattended.

! **NEVER** use as a source of heat for drying objects.

! **NEVER** place objects on the top plate.

## **3 WARNING!! RISK OF BURNS**

! **NEVER** operate the heater without the guard or grill completely attached.

**4 IF POOR QUALITY KEROSENE** is used a rapid accumulation of carbon and tar is likely. This may cause a strong odor and will destroy the wick. Additional heater damage may occur as the wick becomes more difficult to adjust. The use of poor quality fuel could also make the wick very hard to extinguish. Always make sure the fire is out. (See page 12, Extinguishing the Heater.)

**5 ADJUSTMENT OF ROOM TEMPERATURE** cannot be changed by adjusting the heater. A Kerosene heater is either on or off. There is no temperature adjustment. If heater output is reduced by lowering the wick in any way, improper combustion will occur producing odors and an accumulation of tar and carbon. If your room becomes too hot, open a door or a window or turn off the heater.

# SAVE THESE INSTRUCTIONS FOR FUTURE REFERENCE!!

**CONTENTS OF OWNER'S MANUAL**

ITEM	PAGE	ITEM	PAGE
CAUTIONS-SAFETY GUIDE	1	10 CARBON REMOVAL / DRY BURNING	8
1 INTRODUCTION	2	11 WICK ASSEMBLY	9
2 FEATURES	2	12 WICK REPLACEMENT	9~11
3 UNPACKING AND ASSEMBLY	3~4	13 EXTINGUISHING THE HEATER	12
4 KEROSENE (1-K ONLY)	4~5	14 AUTOMATIC SAFETY SHUT-OFF DEVICE	12~13
5 FUELING YOUR HEATER	5	15 LONG TERM STORAGE OF YOUR HEATER	13
6 AUTOMATIC IGNITION SYSTEM	6	16 TROUBLE SHOOTING GUIDE	14
7 CHECKING THE IGNITION SYSTEM	7	17 PARTS LIST	15
8 ADJUSTING THE WICK	7~8	18 EXPLODED PARTS DRAWING	15
9 WICK MAINTENANCE	8	19 SPECIFICATIONS	15

**1 INTRODUCTION**

Please read this OWNER'S MANUAL carefully. It will show you how to assemble, maintain, and operate the heater safely and efficiently to obtain full benefit from its many built-in features.

**2 FEATURES**

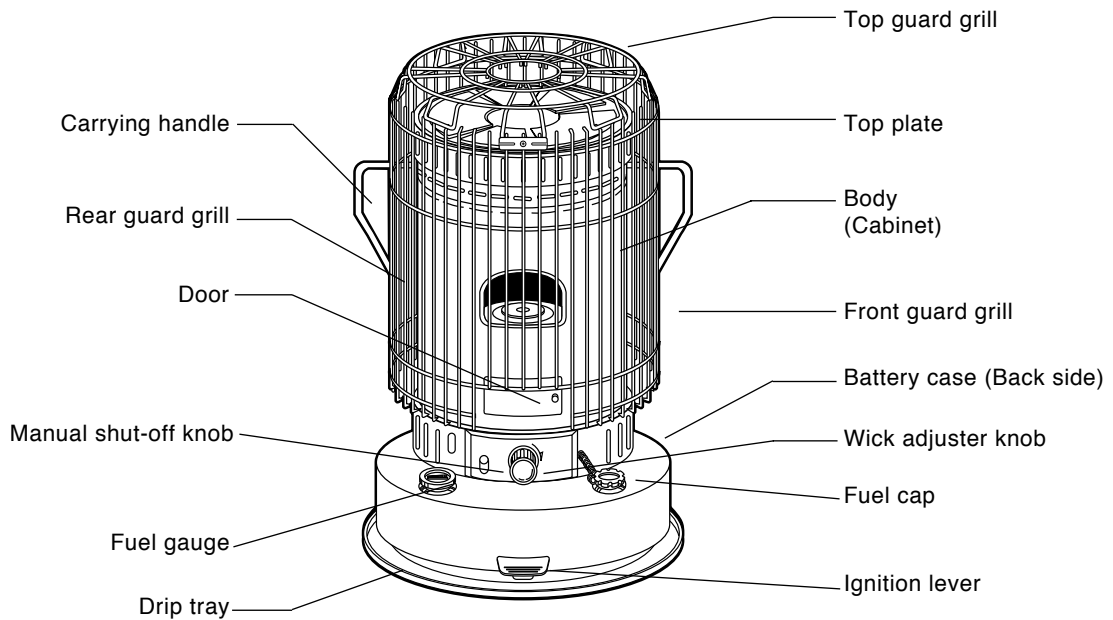

Fig.1

**NEVER LEAVE THE HEATER  
UNATTENDED WHILE BURNING!**

### **3 UNPACKING AND ASSEMBLY**

**CAUTION: "RISK OF BURNS"**

DO NOT OPERATE HEATER WITHOUT INSTALLING THE PROTECTIVE GUARD OR GRILL.

#### **1. REMOVE THE HEATER AND ALL PACKING MATERIALS FROM THE BOX. (Fig.2)**

**NOTE :** Save the shipping carton and packing materials for future storage.

- Heater.
- Top guard.
- Handle.
- Top plate
- 2 "C" cell batteries.
- Siphon pump.
- Bag of screws for top grill assembly.
- Owner's manual.
- Safety Tips Manual.

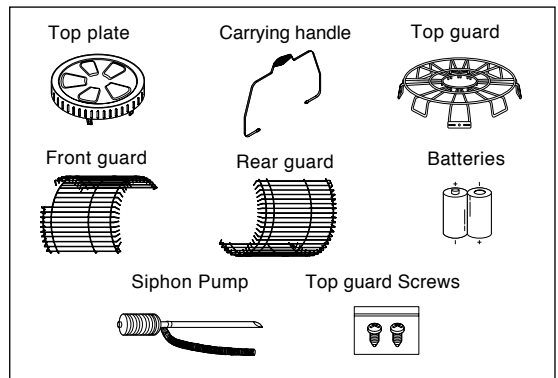

Fig.2

#### **2. ASSEMBLING.**

**A) Remove all packing materials from heater: (Fig.3)**

**B) MOUNTING TOP PLATE: (Fig.4)**

Align the arrow marking on the top plate with the carrying handle hole on the cabinet and place the top plate on the cabinet.

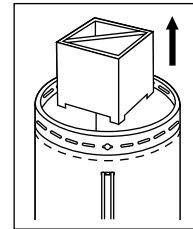

Fig.3

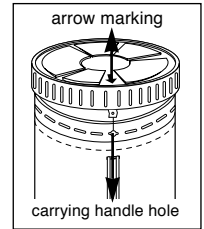

Fig.4

**C) INSTALLING FRONT AND REAR GUARDS:**

(Fig.5A and Fig.5B)

- Hang the upper portion of the front guard (notched to allow for the igniter door) on the Upper Grill brackets with the downward hooked grill rods. (Fig.5A)
- Snap the lower portion of the front guard into the holes in the Lower Grill brackets with the inward hooked grill rods. (Fig.5B)
- Install the rear guard in the same way.

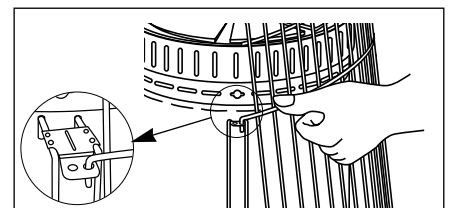

Fig.5A

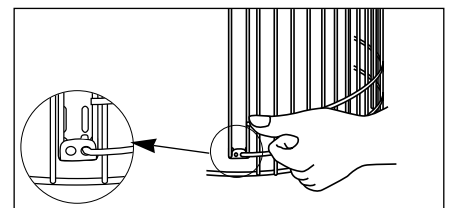

Fig.5B

**NEVER LEAVE THE HEATER  
UNATTENDED WHILE BURNING!**

**D) INSTALLING CARRYING HANDLE:** (Fig.6)

Insert the carrying handle into the holes on the cabinet by aligning holes on brackets of top plate.

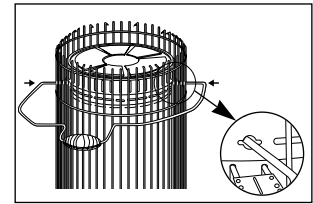

Fig.6

**E) INSTALLING TOP GUARD:** (Fig.7)

- Align the 2 brackets on the top guard with the 2 mounting brackets on the front and rear guards.
- Secure each bracket with a screw. Make sure that the brackets on the top guard are positioned outside the mounting brackets on the front and rear guards.

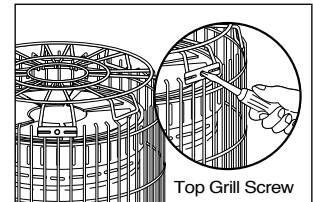

Fig.7

**F) INSTALLING BATTERIES:** (Fig.8)

- Battery holder is located on the back of the heater.
- Open the battery cover from the battery case.
- Insert two(2) "C" cell batteries according to the plus(+) and minus(-) markings inside of the holder.
- Replace the battery cover to the heater.

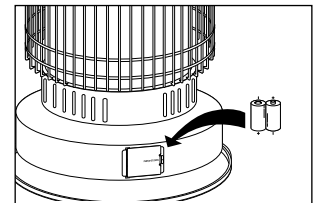

Fig.8

**G) Now your heater is completely assembled:** (Fig.9)

**4 KEROSENE (1-K ONLY)**

It is **EXTREMELY IMPORTANT** to the operation of this heater that you use the proper grade of kerosene. The proper grade of kerosene is identified as **1-K Kerosene**. **DO NOT OPERATE THIS HEATER WITH ANY FUEL OTHER THAN 1-K KEROSENE!** 1-K Kerosene has been refined to virtually eliminate contaminants such as sulphur, which can cause a rotten egg odor during operation of the heater.

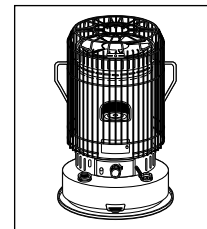

Fig.9

**KEROSENE SHOULD ONLY BE STORED IN A BLUE CONTAINER THAT IS CLEARLY MARKED "KEROSENE". NEVER STORE KEROSENE IN A RED CONTAINER.** Red containers are associated with gasoline.

**NEVER** store kerosene in the living space. Kerosene should be stored in a well ventilated place outside the living area.

**NEVER** use any fuel other than water-clear 1-K kerosene.

**NEVER** use fuel such as gasoline, benzene, alcohol, white gas, camp stove fuel, paint thinners, or other oil compounds in this heater. These are volatile fuels that can cause explosion or uncontrolled flames.

The best way to purchase kerosene is in a pre-packaged, metal or plastic, blue colored container. The second choice would be to buy it from a dealer who stores it in a 55 gallon drum. The third choice is to buy kerosene from a dealer who stores it in a large underground (or above ground) tank. Kerosene that is contaminated with even a small amount of water will prevent a kerosene heater from functioning properly. As you move from the first choice in purchasing kerosene (pre-packaged container) to the third choice (large storage tank), the likelihood of water being present from condensation increases. If you purchase kerosene in bulk, know your dealer.

**NEVER LEAVE THE HEATER  
UNATTENDED WHILE BURNING!**

It is normal for a kerosene heater to give off a slight odor upon start-up and shut-down.

After 5-10 minutes of operation, the heater should have reached its normal operating temperature and any odor should be very slight.

**NEVER** store kerosene in direct sunlight or near a source of heat.

**NEVER** use kerosene that has been stored from one season to the next.

Kerosene deteriorates over time. **"OLD KEROSENE" WILL NOT BURN PROPERLY IN THIS HEATER.**

A variety of problems can result from using poor quality kerosene --- smoke, odor, low flame, difficult ignition, difficult shut-down, flame flickers and dies, excessive burning down of the wick, reduced wick life, wick adjuster sticking, excessive deposits on the wick, etc.. If you encounter any of the problems listed above, check your kerosene. If you discover that the kerosene is the problem, get a fresh supply of **WATER-CLEAR 1-K KEROSENE OR RED DYED 1-K KEROSENE** before using your heater again.

## **5 FUELING YOUR HEATER**

**NEVER FILL THE HEATER FUEL TANK IN THE LIVING SPACE:  
FILL THE TANK OUTDOORS.**

Before fueling the heater, take the heater, the kerosene, and the manual siphon pump outdoors. To use the manual siphon pump, tighten the cap on the top of the siphon, place the straight tube into the kerosene container, and insert the flexible tube into the opening of the fuel tank. By squeezing the bulb of the siphon pump, fuel will be transferred from the kerosene container into the heater tank (Fig.10). Carefully watch the fuel gauge on the base of the heater so that you will know when the tank is getting full. When you approach the full mark, loosen the cap on top of the siphon pump. This will stop the flow of kerosene. **DO NOT OVERFILL YOUR HEATER.** Allow the siphon pump to drain thoroughly before you remove it from the tank and the kerosene container.

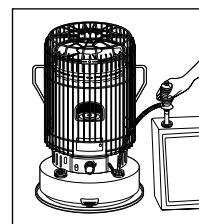

Fig.10

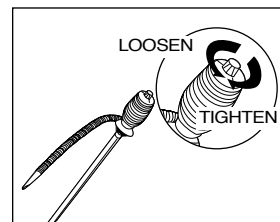

Fig.11

After fueling the fuel tank of the heater by using siphon pump, make sure that you loosen (counter clock wise) the cap on the siphon pump to drain thoroughly the remaining kerosene in the siphon pump. For the reuse of siphon pump, make sure that you tighten (clock wise) the cap on the siphon pump to transfer the kerosene into the fuel tank properly. (Fig.11)

**IMPORTANT NOTICE REGARDING FUELING OF THE HEATER :** When fueling your heater for the first time and any other time when the tank has been completely empty, as in "**Dry Burning**" (page 8) make sure to **allow the wick to soak a minimum 60 minutes** before you attempt to light the heater. Take note of the time you started to soak the wick or use a kitchen timer or wrist watch with an alarm feature. Failure to properly soak the wick can trap air pockets in the wick causing the heater to burn poorly. Premature ignition can destroy your wick.

### **IMPORTANT NOTICE REGARDING FIRST IGNITION OF HEATER**

The first time you light your heater there may be some odor due to the burning off of oils used in the manufacturing process. To avoid this you may wish to burn the heater outside on a calm and windless day. If it's windy consider a porch or garage or other room where the windows can be open to disperse the odor.

**6 AUTOMATIC IGNITION SYSTEM**

For safety and convenience, this heater features an automatic ignition system.

**2 "C"** cell batteries, included with the heater, provide the power for the igniter which lights the wick once it has been raised to its maximum height.

**To use the automatic ignition system:**

- Make sure the batteries have been installed.
- Turn the wick adjuster knob clockwise until the wick has been raised to its maximum height. (Fig.12)
- Push the ignition lever (Fig.13) to bring the glowing igniter into contact with the wick. This will cause ignition to occur.
- As soon as you see that the wick has been lit, release the ignition lever. This will automatically lower the burn chamber back down over the wick.
- Rotate the burner knob from side to side a few times to make sure that the burner is positioned properly on the wick adjuster.
- Then begin following the steps outlined in "Adjusting the wick" (page 7)

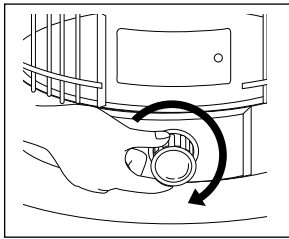

Fig.12

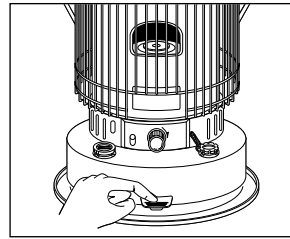

Fig.13

**IGNITION VIA MATCH**

If you encounter a problem with the ignition mechanism, or if you have dead batteries, it is possible to light the heater with a match. (Fig.14)

**The procedure is as follows:**

- Turn the wick adjuster knob clockwise until the wick has been raised to its maximum height.
- Lift the burn chamber by using the burner knob.
- Touch a lighted match to the exposed top edge of the wick.
- Once you see that the wick has been lit, lower the burn chamber back down over the wick.
- Rotate the burner knob from side to side a few times to make sure that the burner is positioned properly on the wick adjuster.
- Then begin following the steps outlined in "Adjusting the wick" (page 7)

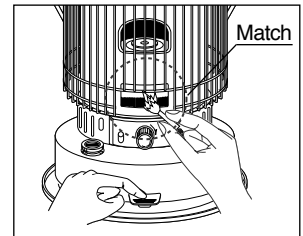
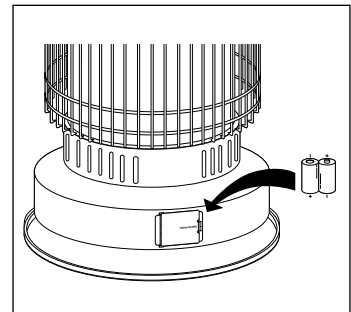
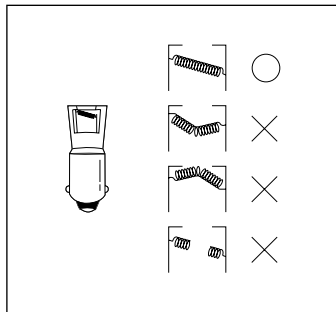
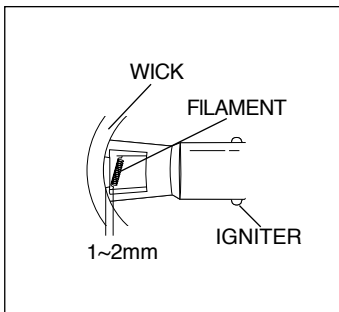

Fig.14

**CAUTION :** Make sure that you do not leave the match, or any portion of it (match head, etc.) in the burner area. Debris left from the match can cause an uneven alignment of the burner and may result in smoke, incomplete combustion, odor, or fire.





**NEVER LEAVE THE HEATER  
UNATTENDED WHILE BURNING!**

## **7 CHECKING THE IGNITION SYSTEM**

If the automatic ignition system fails to operate properly,

### **perform the following checks:**

- **BATTERIES -2 "C"** cell batteries are located at the rear of the heater.  
Replace with new batteries.
- **IGNITER PLUG** - If the automatic ignition system still doesn't work after replacing the batteries, check the igniter plug. If the glow coil filament is broken, bent, or doesn't glow when engaged via the ignition lever, it must be replaced.

**CAUTION: Be sure igniter plug is Type "B", 2.5V DC, 1A only.**

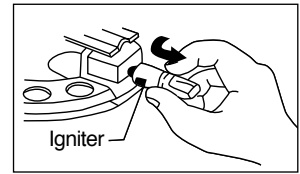

Fig.15

### **To replace the igniter plug (Fig.15):**

- Remove the batteries.
  - Remove the 2 cabinet screws and lift off the cabinet and grill assembly.
  - Pull the ignition lever to raise the igniter plug.
  - Push the igniter plug in and turn in a **clockwise** direction to remove.
  - Install a new igniter plug (Type "B", 2.5V DC, 1A only) by pushing it in and turning it in a **counter-clockwise** direction.
  - Reassemble the heater and replace the batteries.
- **TEST IGNITION** - Using the wick adjuster knob, raise the wick to its maximum height.  
Pull the ignition lever.  
The igniter plug should be within 1~2mm of the wick when the ignition lever is fully engaged.

## **8 ADJUSTING THE WICK**

After lighting the heater, it is important to check the heater flame within the first 5-7 minutes of operation. During the first 5 minutes after ignition, the burner chamber warms up and flames will become visible at the top of burner. These flames will gradually build up. After 5-7 minutes of operation, you should use the wick adjuster knob to obtain the proper flame height. The proper flame height is a 1/2" flame above the center flame spreader disk, with even distribution of flame around the flame spreader disk visible through the clear window of the heater. See pictures below for reference.

As you continue to operate the heater, the temperature of the heater and the temperature of the room will continue to change. As the heater warms up, the kerosene in the tank will vaporize faster, and this could require adjusting the wick adjuster down in order to maintain the desired 1/2" flame height. Therefore, it is necessary to continue to monitor the flame height, and to make adjustments using the wick adjuster knob to keep the proper flame height. It is recommended that the heater be checked every 30 minutes in order to keep the proper adjustment because periodic adjustment is required.

Fig.16

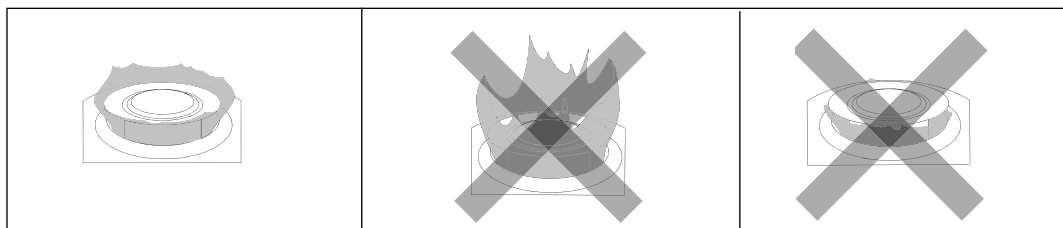

**CORRECT FLAME**  
Proper combustion

**FLAME TOO HIGH**  
Can Produce smoke  
and soot

**FLAME TOO LOW**  
Can produce odor  
and carbon monoxide

### **IMPORTANT NOTE : NEVER LEAVE THE HEATER UNATTENDED WHILE BURNING.**

Always make sure to turn the heater off and inspect it to insure that it is completely extinguished prior to going to bed.

**NEVER LEAVE THE HEATER  
UNATTENDED WHILE BURNING!**

**NOTE :** During start-up, small adjustments to the flame can be performed by using the burner knob on the front of the burner and **MOVING THE BURNER FROM SIDE TO SIDE** until the flame at the top of burner is as even as possible. **THIS HEATER WILL PRODUCE SOOT AND SMOKE IF THE BURNER IS NOT SEATED PROPERLY. DO NOT TOUCH THE BURNER KNOB ONCE THE HEATER HAS REACHED NORMAL OPERATING TEMPERATURE AND THE FLAME HAS STABLIZED. THE BURNER KNOB IS VERY HOT DURING OPERATION.**

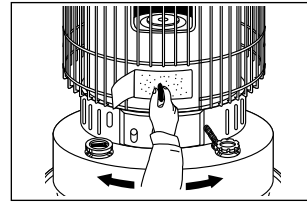

Fig.17

**IMPORTANT NOTE :** This heater is designed to operate with a flame height of a 1/2" above the flame spreader disk at the top of the burner. For proper combustion to occur, it is **very important** that the flame height be adjusted so that it is neither too high, nor too low. Operating the heater at a wick setting below the minimum recommended setting (the wick-stop setting) can result in the risk of carbon monoxide poisoning.

**NOTE :** If you find that the wick will not raise, push the safety reset lever (see diagram on P.2) to engage the safety shut-off device. Then dial the wick up via the wick adjuster knob.

**WARNING : RISK OF INDOOR AIR POLLUTION AND FIRE, DO NOT OPERATE HEATER AT WICK SETTING LOWER THAN MINIMUM WICK-STOP SETTING OR WITH AN EXCESSIVE FLAME HEIGHT.**

## **9 WICK MAINTENANCE / DRY BURN**

Wick maintenance is necessary to prevent soot production, low heat output and performance issues. Carbon and tar will build up on the top of the wick during regular use of this product. Wick maintenance is required within the first seven (7) days of your first use of the heater and every 2 tankfuls of fuel and/or every week during the heating season. If the wick feels hard and brittle, this indicates that wick maintenance is necessary in order to keep your heater performing accordingly.

### **Check Your Wick Often!**

- ✓ If the wick is hard to light.
- ✓ If the wick is hard to raise or difficult to adjust by turning the wick adjustment knob.
- ✓ If the wick fails to drop completely when you press the shut-off knob.
- ✓ If the top of the wick is stiff and hard.

Note: Poor fuel or fuel contaminated with water will also turn the wick hard.

## **10 PERFORMING WICK DRY BURN / REMOVING CARBON FROM THE WICK**

"Dry burning" your heater will cause a strong odor. For this reason it is best to "dry burn" your heater outdoors on a day that is completely calm and windless. If it's too windy outside you can consider a porch, breezeway or other room with all of the windows open to disperse the strong odor.

Step 1 With your fuel tank nearly empty, burn your heater (without refilling) until the flame starts to burn out then raise the wick to its highest possible setting and leave it there until it burns out completely. Wait 60 minutes, then re-light the wick (with a match if necessary) and allow it to burn out again. Once the heater is cool to the touch, remove the cabinet and brush the top of the wick with an old tooth brush or other stiff bristle brush to remove any remaining ash. A canister type vacuum cleaner may be a useful tool in removing this ash.

Step 2 The first step should remove most carbon and your wick should feel softer to the touch. If any part still feels hard, you can use small pliers to pinch these hard spots and break up the carbon into pieces. After doing this, replace the cabinet, add a small amount of fuel, wait at least one hour and then repeat step 1.

Carry out Carbon Removal / Dry Burning within (7) seven days after your first use of your new heater to reduce carbon build-up on the wick's burning surface, after every two tankfuls of fuel and/or every week during the heating season. Afterwards, dry burn your heater anytime the wick appears to be hard. **CHECK YOUR WICK OFTEN!** Dry burn your wick and remove all fuel from your heater at the end of the heating season.

**Note: Burn your heater dry, as noted above, weekly during the heating season or necessary thereafter. Check your wick often to see if CARBON REMOVAL / DRY BURNING is necessary. Carbon removal will NOT be effective if your fuel has been contaminated by water or any other liquid. In this case you must clean the fuel tank, replace the wick and soak it for 60 MINUTES in fresh, K-1 Kerosene.**

**NEVER LEAVE THE HEATER  
UNATTENDED WHILE BURNING!**

**11 WICK ASSEMBLY- Check at least once a month!!**

The burner assembly sits on top of the wick guide. Over time, tar deposits can accumulate on the wick guide, and this can prevent the burner assembly from seating properly. This can result in poor combustion, smoke, odor, etc.. To prevent this from happening, tar deposits on the wick guide can be removed as follows:

- Making sure that the heater is both cool and turned off, lower the wick to the "off" position.
- Remove the batteries (located at the rear of the heater).
- Remove the 2 cabinet screws. Lift off the cabinet and grill assembly as shown in illustration. (Fig.A)
- Using the wick adjuster knob, raise the top of the wick until it is even with the top of the wick guide. Using a flat-edge screwdriver, scrape off the tar deposits. Be careful not to allow any of the tar deposits to drop into the grooves of the wick guide. A small vacuum cleaner can be used to remove the tar deposits that have been scraped off. (Fig.B)
- Reassemble the heater and replace the batteries.

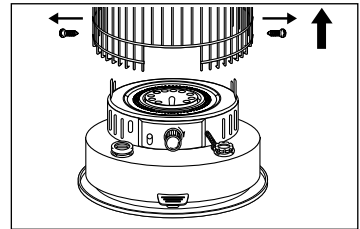

Fig.A

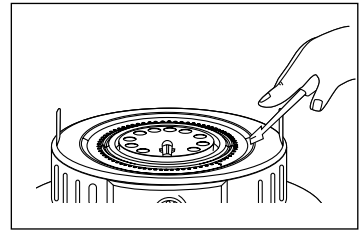

Fig.B

**12 WICK REPLACEMENT**

The wick in your heater needs replacing if, after repeated cleanings, any of the following conditions still exist: slow to light, hard movement of the wick adjuster knob, kerosene odor while burning, low heat output, slow warm up, damaged wick.

**Use only a genuine replacement wick.**

**REPLACEMENT WICK NUMBER: Kero-World 32225, Dura Heat DH-145, Glowick 30856.**

If cleaning the Wick does not improve performance, you will need to replace the wick. Refer to the "TROUBLE SHOOTING GUIDE", see page 14, which outlines conditions under which the wick should be replaced.

DO NOT attempt to substitute any other type of wick device or a wick designed for another brand or model heater. You could damage the heater and create a potential fire hazard.

Call customer service at 1-877-447-4768, to order a wick.

**ATTENTION :** The only tools needed to replace the Wick are :

- A pair of pliers
- A flat blade screwdriver
- A plastic bag with a twist tie

Visit our website at: [www.ghpgroupinc.com/heaters/faqs.aspx](http://www.ghpgroupinc.com/heaters/faqs.aspx) and select RMC-95C6 /RMC-95C6B for a link to a detailed video demonstrating wick replacement.

1. Push down the manual shut-off knob and turn the wick adjustment knob COUNTERCLOCKWISE in the direction of "OFF".

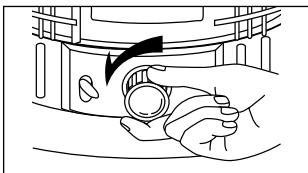

2. Use a screwdriver to loosen and remove cabinet screws on either side of the heater cabinet.

3. Use the carrying handle to lift the cabinet straight up and away from the heater.

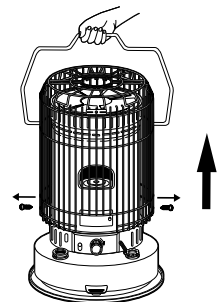

4. Gently pull the wick adjustment knob off the heater.

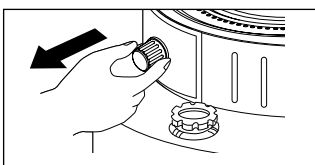

5. Remove the cabinet base by lifting it from the back and tilting it forward to clear the wick adjuster assembly.

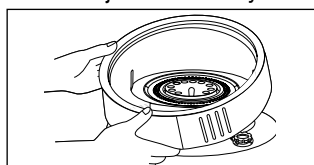

6. Trip the pendulum on the automatic safety shutoff system to lower the wick.

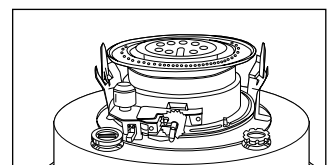

**NEVER LEAVE THE HEATER  
UNATTENDED WHILE BURNING!**

7. Remove the four wing nuts which hold the wick assembly to the heater and carefully lift the wick assembly from the heater.

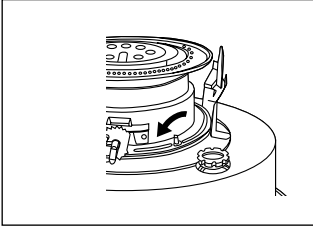

8. Replace the wick adjustment knob temporarily. Turn the knob **CLOCKWISE** to raise the wick.

9. Hold the wick assembly up-side-down, using caution, grasp the wick cover firmly **PULL** it off with a sharp tug. If you have difficulty doing so, try loosening the wick cover with a flat blade screwdriver.

**CAUTION :** The inside of wick cover has sharp teeth. The use of work gloves is suggested to avoid injury.

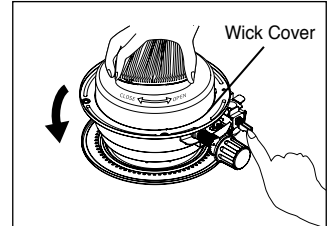

10. Remove the wick by folding it to the inside. Then remove the wick sleeve from the bottom of the assembly.

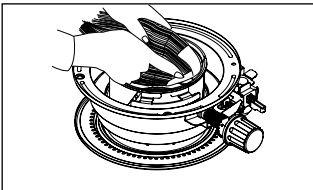

11. Install the new wick and insert the 3 pins on a new wick into the 3 holes on the wick sleeve in the upward direction. (See the arrow marked "↑ up" on the wick sleeve)

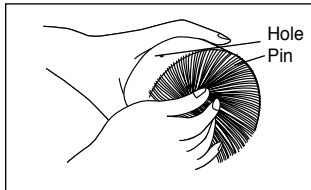

12. Push the new wick into the retainer teeth of the wick sleeve so that the wick adheres tightly around the inside of the wick sleeve, smoothing out any wrinkles.

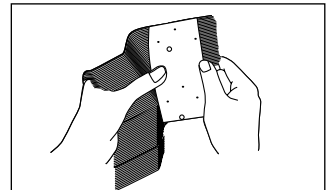

**NOTE : DO NOT DISASSEMBLE THE STAINLESS STEEL WICK HOLDER.**

13. Line up the pins with the slotted holes inside the wick adjuster. Then lightly press each of the three pins of the wick (now attached to the wick sleeve) toward the center, away from the slanted grooves of the wick adjuster allowing the wick to drop slightly. Once the pins line up with each hole, press firmly on each pin toward the slanted grooves securely through each hole.

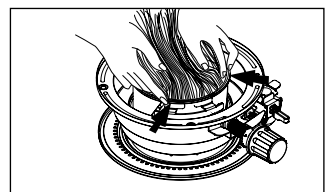

**NOTE :** Turn the wick adjustment knob and check to be sure that the wick moves up and down freely.

14. The wick height will automatically be set to the correct burning height of 3/8" (10mm).

**NOTE :** Be sure to check wick height. It should be 3/8".

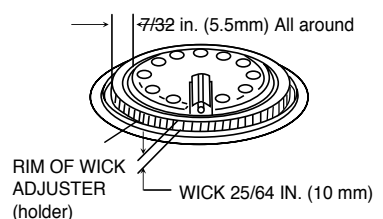
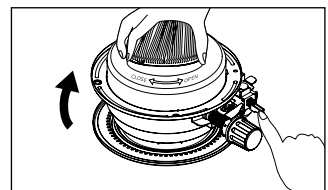

15. Turn the wick assembly upside down to replace the wick cover.
16. Align the tabs on the wick cover with the four screw holes on the bottom of the assembly, as shown, and snap it into place. Be certain of firm contact at all points.
17. Be sure the rubber seal on tank is properly seated. <Fig. B>

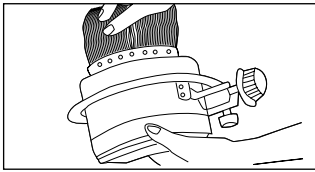

Fig.A

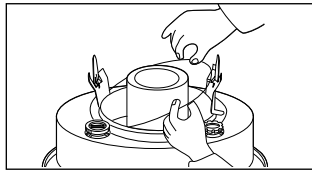

Fig.B

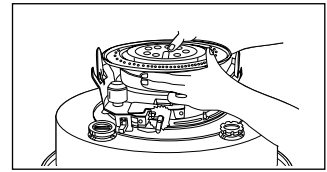
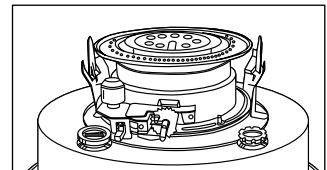

Fig.C

18. (1) Turn the wick adjustment knob to the fully raised position. (2) Pull lightly on the skirt of the wick to remove any slack. (3) Press lightly to secure the skirt to the retainer teeth on the wick cover. (4) You will need to hold the knob in the clockwise position to keep the wick raised. <Fig. A>



※ WICK INSTALLATION TIP

\*\* Lock the tip over switch (TOS) by inserting locking pliers or a clothes pin between the TOS plates, preventing the weight from triggering the TOS mechanism as you install the new wick. Install the new wick in the raised position. Remember to remove pliers or clothes pin before reassembling & lighting heater.

19. (5) Replace the wick assembly on the heater with the wick raised. (6) The wick adjuster knob will need to be positioned between the caution and warning labels. <Fig.C> (7) Replace two diagonally opposite wing nuts first. (8) Then the remaining two. (9) Tighten each of the four wing nuts gradually until the wick assembly is firmly in place.
20. While your heater is disassembled, check the Automatic Safety Shutoff system. Remove the locking pliers or clothes pin from the TOS mechanism if you used them to assist with the wick installation. Trip the automatic shutoff system by nudging the pendulum. Raise the wick by turning wick adjuster knob. Trip it again to make certain it is operating correctly.
21. Turn the Wick Adjustment knob to test its operation. Be certain the Wick operates smoothly as the knob is turned CLOCKWISE and COUNTER-CLOCKWISE.
22. Test Ignition. Raise the Wick to its full height. The Ignition Plug should be within 3/64" to 5/64" (1 mm to 2 mm) of the Wick when the Lever is pulled. (CAUTION : Do not touch the HOT, glowing ignitor!)
23. Be sure to check that the wick is set at the correct height of 3/8" (10 mm)
24. Remove Wick adjustment knob which you had temporarily replaced to test wick operation.
25. Replace the cabinet base making certain to align the automatic safety shutoff system lever and the wick adjustment shaft, which holds the knob, with the appropriate slots in the cabinet base. Begin by aligning them and gently snap the cabinet base in place over the wick assembly.
26. Replace the heater cabinet. Make certain the grill guard prongs are inserted securely into the proper holes on the heater, and the front cabinet matches the front of the heater.
27. Fasten the cabinet to the heater with the two screws.
28. Replace the wick adjustment knob. To be certain it is properly positioned on the wick adjustment shaft, raise the wick to its full height.

### **13 EXTINGUISHING THE HEATER**

To extinguish the heater, push down on the manual shut-off knob (Fig.18) with one hand while holding the wick adjuster knob in the other hand. You will feel the pressure of spring action attempting to turn the wick adjuster knob in a counter-clockwise direction in your hand. By slowly relaxing your grip on the wick adjuster knob, you will allow the spring to gradually lower the wick and extinguish the flame. When there is no further pressure from the spring action, confirm that the wick has been fully lowered by turning the wick adjuster knob in a counter-clockwise direction as far as it will go.

After 10-15 seconds, open the door on the body of the heater, lift the burner using the burner knob, and visually confirm that there are no flames present. This will confirm that the heater is completely extinguished.

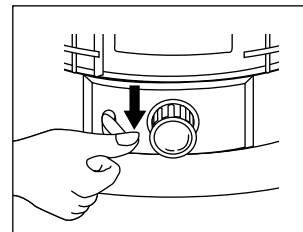

Fig.18

**CAUTION** : After extinguishing the heater, **allow at least 10 minutes before reigniting the heater**. This allows the heater time to cool off and return to a normal temperature. Failure to allow the 10 minute cooling off period before reigniting the heater will result in the creation of a strong odor and possible flare-up.

**WARNING** : Carbon and tar can build up on the wick after the heater has been in use for a while. This can interfere with the ability of the wick to be lowered into the body of heater, and can result in the flame not extinguishing completely. It is the responsibility of the owner to inspect the wick, to maintain proper maintenance of the wick, and to replace the wick when necessary in order to prevent the build up of carbon and tar from creating a dangerous situation where the heater does not fully extinguish.

### **14 AUTOMATIC SAFETY SHUT-OFF DEVICE**

This heater is equipped with an automatic safety shut-off device. The purpose of this device is to quickly and efficiently shut-off the heater should the heater be jarred or tipped over while in operation. This is the main safety system that is built into the heater, and it functions to prevent the flame from spreading if the heater is knocked over.

The automatic safety shut-off device is built into the mechanism that raises and lowers the wick. It has been designed so that if the pendulum is jarred by a shock of some sort, it retracts a latch from the wick control shaft ratchet, and a torsion spring reacts to drop the wick to its fully lowered position. This rapid lowering of the wick extinguishes the flame.

If you find that the wick will not raise, push the manual shut-off knob (see diagram on P.2) to engage the automatic safety shut-off device. Then dial the wick up via the wick adjuster knob.

**IMPORTANT NOTICE** : For the safety shut-off device to function properly, the wick must be free of carbon and tar deposits. Regularly performing the "Carbon Removal / Dry burning" procedure described in the "Wick Maintenance" and "Carbon Removal / Dry Burning" sections on page 10 is very important to the proper functioning of this important safety device.

**IMPORTANT NOTICE** : PLEASE CHECK THE SAFETY SHUT-OFF DEVICE ONCE A WEEK DURING THE HEATING SEASON TO INSURE THAT IT IS FUNCTIONING PROPERLY.

**IMPORTANT NOTICE** : EVERY TIME THE WICK IS REMOVED OR REPLACED, THE SAFETY SHUT-OFF DEVICE MUST BE TESTED TO INSURE THAT IT IS FUNCTIONING PROPERLY.

**NEVER LEAVE THE HEATER  
UNATTENDED WHILE BURNING!**

**TESTING THE SAFETY SHUT-OFF DEVICE :** At least once a week during the heating season, it is important to test the safety shut-off device to be sure that it is operating properly. **WITH THE HEATER TURNED OFF**, raise the wick using the wick adjuster knob to the fully raised position. Grabbing the protective grill, give the heater a firm shake. If the safety shut-off device is working properly, you will hear a loud noise as the ratchet is disengaged and the torsion spring drops the wick into the body of the heater. To verify that the wick has been completely lowered, turn the wick adjuster knob in a counterclockwise direction. If the safety shut-off device is functioning properly, the wick will have been completely lowered. If you are able to lower the wick further using the wick adjuster knob, this means that it is time to perform the "Carbon Removal Dry Burning" procedure described on page 8 again.

## **15 LONG TERM STORAGE OF YOUR HEATER**

Carefully following the instructions for storage given below will insure that your heater will operate efficiently and safely next season (Fig.19/ Fig.20).

- Using a small amount of kerosene, swirl and rinse the inside of the tank. **NEVER mix water with the kerosene** as it will cause rust inside the tank. Pour the kerosene out making sure that you remove it all.
- With the fuel tank empty, ignite the heater. With the wick at its maximum height, keep the wick burning until it burns out completely (about 1 hour). It is a good idea to do this outside or in an extremely well- ventilated area.
- Remove the batteries. Remove the 2 cabinet screws and lift off the cabinet and grill assembly. Remove the burner. Remove the wick adjuster from the fuel reservoir. Thoroughly dry the inside of the fuel tank. Using a screwdriver and/or a brush, remove any carbon, tar or soot that might have accumulated on the wick adjuster, wick guide or burner.
- After a thorough cleaning, reassemble the heater. It is important when reassembling the wick adjuster to be sure to maintain an equal gap between the wick adjuster and the wick guide cylinder all around. See "Wick Replacement" on page 7 for reference.
- Remove the batteries from the battery case before storing the heater to prevent leakage and corrosion.
- Store the heater with the wick in the fully lowered position and the safety shut-off device deactivated.
- Store the heater in the original box with the original packing material and keep the **OWNER'S MANUAL** with the heater. Store in an area that is well- ventilated.

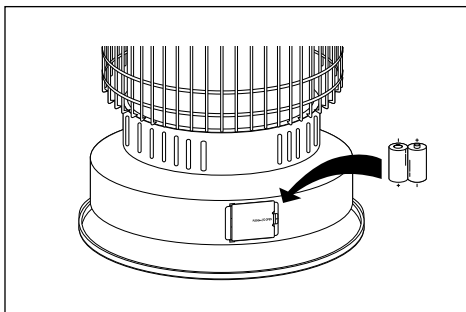

Fig.19

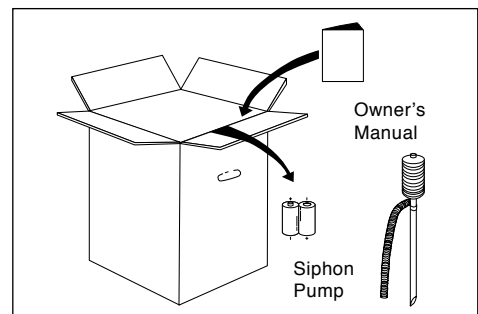

Fig.20

**16 TROUBLE SHOOTING GUIDE**

TROUBLE	CORRECTIVE ACTION
<p><b><u>Heater Will Not Light ;</u></b></p> <ol style="list-style-type: none"> <li>1. Fuel tank is empty</li> <li>2. Water present in kerosene</li>   <li>3. Igniter plug fails to glow</li> <li>4. Igniter plug makes contact with side of wick</li> </ol>	<ol style="list-style-type: none"> <li>1. Fill tank with <b>water-clear 1-K kerosene or red dyed 1-K kerosene.</b></li> <li>2. Drain tank. Remove wick assembly &amp; replace wick. Reinstall wick assembly. Fill tank with <b>water-clear 1-K kerosene or red dyed 1-K kerosene.</b></li> <li>3. Replace batteries. Replace igniter plug. Check for broken or disconnected wire.</li> <li>4. Lower wick using wick adjuster knob until igniter plug makes contact with top of wick.</li> </ol>
<p><b><u>Heater Produces Smoke or Odor ;</u></b></p> <ol style="list-style-type: none"> <li>1. Flame is too high</li> <li>2. Heater is in an air draft</li> <li>3. Burner is not level</li>   <li>4. Carbon or tar built up on wick</li> <li>5. Contaminated kerosene</li> </ol>	<ol style="list-style-type: none"> <li>1. Using wick adjuster knob, lower wick to desired 1/2" flame.</li> <li>2. Move heater out of air draft.</li> <li>3. Using burner knob, rotate burner from side to side until it seats properly over wick.</li> <li>4. Perform "Carbon Removal / Dry Burning" procedure. Replace wick if necessary.</li> <li>5. Drain tank. Remove wick assembly &amp; replace wick. Reinstall wick assembly. Fill tank with <b>water-clear 1-K kerosene or red dyed 1-K kerosene.</b></li> </ol>
<p><b><u>Flame Flickers or Dies ;</u></b></p> <ol style="list-style-type: none"> <li>1. Water present in kerosene</li>   <li>2. Carbon or tar built up on wick</li> </ol>	<ol style="list-style-type: none"> <li>1. Drain tank. Remove wick assembly &amp; replace wick. Reinstall wick assembly. Fill tank with <b>water-clear 1-K kerosene or red dyed 1-K kerosene.</b></li> <li>2. Perform "Carbon Removal / Dry Burning" procedure. Replace wick if necessary.</li> </ol>
<p><b><u>Wick Burning Down Excessively ;</u></b></p> <ol style="list-style-type: none"> <li>1. Dangerous, volatile fuel mixed with kerosene (gasoline, benzene, alcohol, white gas, paint thinner, camp, stove fuel, oil compound)</li> </ol>	<ol style="list-style-type: none"> <li>1. Drain and clean tank             <ul style="list-style-type: none"> <li>- Remove and replace wick</li> <li>- Fill tank with <b>water-clear 1-K kerosene or red dyed 1-K kerosene.</b></li> </ul> </li> </ol>
<p><b><u>Wick Adjuster Sticks ;</u></b></p> <ol style="list-style-type: none"> <li>1. Water present in kerosene</li>   <li>2. Carbon or tar built up</li> </ol>	<ol style="list-style-type: none"> <li>1. Drain tank. Remove wick assembly &amp; replace wick. Reinstall wick assembly. Fill tank with <b>water-clear 1-K kerosene or red dyed 1-K kerosene.</b></li> <li>2. Perform "Carbon Removal / Dry Burning" procedure. Replace wick if necessary.</li> </ol>
<p><b><u>Wick will not raise ;</u></b></p>	<ul style="list-style-type: none"> <li>- Push the safety reset lever (see diagram on P.2) to engage the automatic safety shut-off device. Then dial the wick up via the wick adjuster knob.</li> </ul>
<p><b><u>Heater is enveloped in flames ;</u></b></p>	<ul style="list-style-type: none"> <li>- Call Fire Department.</li> <li>- Exit quickly and warn others.</li> <li>- DO NOT: Move heater, try to smother fire, or put water on fire.</li> </ul>



**NEVER LEAVE THE HEATER  
UNATTENDED WHILE BURNING!**

## 17 PARTS LIST

DRAWING NUMBER	DESCRIPTION	PART NUMBER
1	TOP GRILLE	PS-CV01
2	CARRYING HANDLE	WS-CV02R
3	TOP PLATE(WK95C6C)	WS-CV03B
4	BURNER ASS'Y	WS-CV04
5	WICK COVER	WS-CV25
6	REAR GRILLE	PS-CV060
7	CABINET BASE(WK95C6C)	WS-CV12B
8	WIND COVER	WS-CV17
9	WICK ADJUSTER ASS'Y (COMPLETE)	2113-0032-00
10	WICK	See Below
11	WICK ADJUSTER GASKET	PS-CV19R
12	SAFETY SHUT OFF DEVICE	See 9
13	DRIP TRAY ASS'Y(WK95C6C)	PS-CV32R1B
14	FUEL CAP GASKET	WS-CV30
15	FUEL CAP ASSY	WS-CV29
16	WICK ADJUSTER KNOB(WK95C6C)	WS-CV14B
17	BATTERY CASE ASS'Y(WK95C6C)	WS-CV27R1B
18	FRONT GRILLE	PS-CV061
19	CABINET(WK95C6C)	PS-CV08RB
20	MICA WINDOW	WS-CV09
21	DOOR(WK95C6C)	WS-CV34B
22	FUEL GAUGE	WS-CV21
23	FUEL GAUGE GASKET	WS-CV22
24	TANK ASS'Y(WK95C6C)	PS-CV23R3B
25	IGNITER ASS'Y	PS-CV24R1
26	WICK SLEEVE	PS-CV35

## 18 EXPLODED PARTS DRAWING

**NOTE : SPECIFY MODEL NUMBER AND PART NUMBER WHEN ORDERING PARTS.**

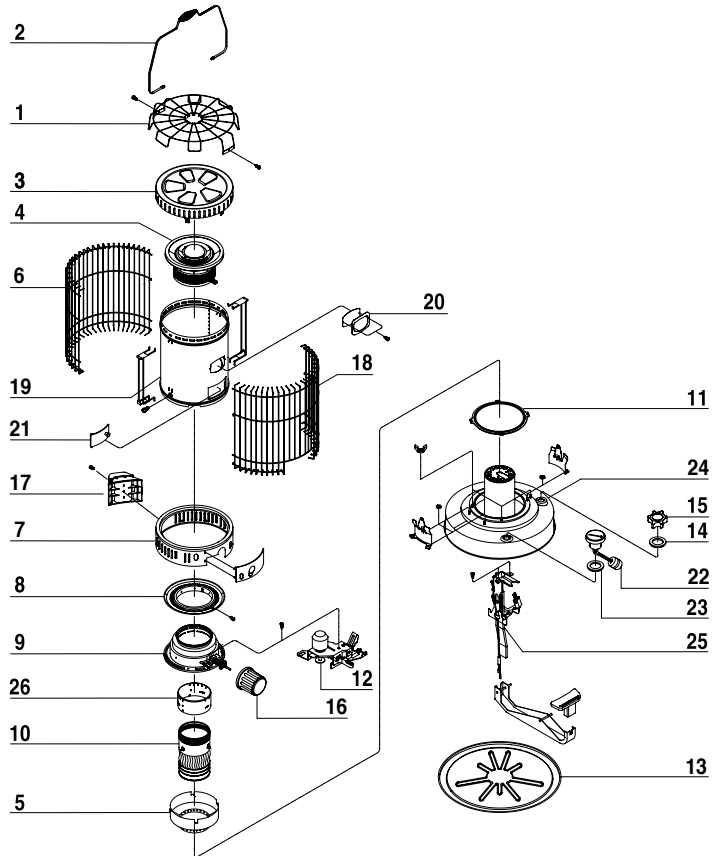

## 19 SPECIFICATIONS

Model No.		WK95C6C
Type of Heater		Convection
Heat Output		Max. 23,800 BTU/hr
Fuel Tank		Integral
Tank Capacity		1.9 U.S. gallons
Continuous Combustion Time		Approx. 8-12 hr
Max. Fuel Consumption		0.180 U.S. gallons/hr.
Ignition Method		Battery-C Cell x2, Igniter Type "B"
Dimensions	Height	27 inches
	Width	17.5 inches
	Depth	17.5 inches
Wick Height		25/64 IN. (10mm)
Replacement Wick Number		Kero-World 32225, Dura Heat DH-145, Glowick 30856

# Warranty

## LIMITED WARRANTY:

This limited warranty is extended to the original retail purchaser of this Forced Air/Convection/Radiant Heater and warrants against any defect in materials and workmanship for a period of one (1) year from the date of retail sale. GHP Group, Inc., at it's option, will either provide replacement parts or replace or repair the unit, when properly returned to the retailer where purchased or one of our service centers as directed by GHP Group, Inc., within one (1) year of retail purchase. (Shipping costs, labour costs, etc. are the responsibility of the purchaser.)

## DUTIES OF THE OWNER:

This heating appliance must be operated in accordance with the written instructions furnished with this heater. This warranty shall not excuse the owner from properly maintaining this heater in accordance with the written instructions furnished with this heater. A bill of sale, canceled check or payment record must be kept to verify purchase date and establish warranty period. Original carton should be kept in case of warranty return of unit.

## WHAT IS NOT COVERED:

1. Damage resulting from use of improper fuel.
2. Damage caused by misuse or use contrary to the owners manual and safety guidelines.
3. Damage caused by a lack of normal maintenance.
4. Fuses
5. Use of non-standard parts or accessories.
6. Damage caused in transit. Freight charges on warranty parts or heaters to and from the factory shall be the responsibility of the owner.

This warranty does not imply or assume any responsibility for consequential damages that may result from the use, misuse, or the lack of routine maintenance of this heating appliance. A cleaning fee and the cost of parts may be charged for appliance failures resulting from lack of maintenance. This warranty does not cover claims which do not involve defective workmanship or materials. **FAILURE TO PERFORM GENERAL MAINTENANCE (INCLUDING CLEANING) WILL VOID THIS WARRANTY.**

THIS LIMITED WARRANTY IS GIVEN TO THE PURCHASER IN LIEU OF ALL OTHER WARRANTIES, EXPRESSED OR IMPLIED, INCLUDING BUT NOT LIMITED TO THE WARRANTIES OF MERCHANTABILITY OF FITNESS FOR A PARTICULAR PURPOSE. THE REMEDY PROVIDED IN THIS WARRANTY IS EXCLUSIVE AND IS GRANTED IN LIEU OF ALL OTHER REMEDIES. IN NO EVENT WILL GHP GROUP, INC. BE LIABLE FOR INCIDENTAL OR CONSEQUENTIAL DAMAGES.

Some states do not allow limitations on how long an implied warranty lasts, so the above limitation may not apply to you. Some states do not allow the exclusion or limitation of incidental or consequential damages so the above limitation or exclusion may not apply to you.

## CLAIMS HANDLED AS FOLLOWS:

1. Contact your retailer and explain the problem.
2. If the retailer is unable to resolve the problem, contact our Customer Service Dept. detailing the heater model, the problem, and proof of date of purchase.
3. A representative will contact you. DO NOT RETURN THE HEATER TO GHP GROUP, INC. unless instructed by our Representative. This warranty gives you specific legal rights and you may also have other rights which vary from state to state.

TO REGISTER THE WARRANTY ON YOUR HEATER, PLEASE FILL OUT THIS CARD COMPLETELY  
AND MAIL WITHIN 14 DAYS FROM DATE OF PURCHASE OR REGISTER ON-LINE AT [www.ghpgroupinc.com](http://www.ghpgroupinc.com)

NAME: \_\_\_\_\_ PHONE: (     ) \_\_\_\_\_ EMAIL: \_\_\_\_\_  
ADDRESS: \_\_\_\_\_ CITY: \_\_\_\_\_ STATE: \_\_\_\_\_ ZIP: \_\_\_\_\_  
MODEL: \_\_\_\_\_ SERIAL #: \_\_\_\_\_ DATE PURCHASED: \_\_\_\_\_  
DEALER PURCHASED FROM: \_\_\_\_\_ TYPE OF STORE: \_\_\_\_\_  
CITY & STATE WHERE PURCHASED: \_\_\_\_\_ PRICE PAID: \_\_\_\_\_

**Please Take a Minute To Give Us Your Answers To The Following Questions.**

**All Responses Are Used Solely For Market Research And Are Held In Strict Confidence.**

Who primarily decided this purchase?  Male  Female  18-24  25-39  40-59  60 and over

Purpose of Purchase? \_\_\_\_\_

Do you own any other portable heaters?  Yes  No If yes, type \_\_\_\_\_ brand \_\_\_\_\_

How do you intend to use your new heater?  Construction Site  Farm  Warehouse/Commercial  Garage/Outbuilding  Other

How did you become aware of this heater?  In-Store Display  Newspaper Ad  Magazine Ad  Friend/Relative

TV Commercial  Store Salesperson  Other \_\_\_\_\_

What made you select this heater?  Style  Size/Portability  Price  Package  Brand  Other \_\_\_\_\_

Do you:  own  rent Would you recommend this heater to a friend?  Yes  No

Please give us your comments: \_\_\_\_\_

THANK YOU FOR COMPLETING THIS FORM!

Information will be held confidential.

## **WARRANTY REGISTRATION**

**IMPORTANT: We urge you to fill out your warranty registration card within fourteen (14) days of date of purchase. You can also register your warranty on the internet at [www.ghpgroupinc.com](http://www.ghpgroupinc.com). Complete the entire serial number. Retain this portion of the card for your records.**



**GHP Group, Inc.**  
6440 W Howard St  
Niles, IL 60714-3302

Tel: (877) 447-4768  
[www.ghpgroupinc.com](http://www.ghpgroupinc.com)

**SAVE THIS CARD!**

Place  
Postage  
Stamp  
Here

**GHP Group, Inc.**  
6440 W Howard St  
Niles, IL 60714-3302