

This Owner's Manual is provided and hosted by [Appliance Factory Parts](#).



Broil King 9869-77 Owner's Manual

[Shop genuine replacement parts for Broil King 9869-77](#)

Broil King®

[Find Your Broil King Grill Parts - Select From 1349 Models](#)

----- Manual continues below -----

Broil King®

REDDI-BILT BARBECUES

ASSEMBLY MANUAL & PARTS LIST

MANUEL DE MONTAGE & LISTE DE PIÈCES



Broil King

SIGNET 20
9865-14
9865-17
SIGNET 20B
9869-54
9869-57
SOVEREIGN 20
9875-14
9875-17



Broil King

SIGNET 40
9865-24
9865-27
SOVEREIGN 40
9875-24
9875-27



Broil King

SIGNET 70
9865-34
9865-37
SIGNET 70S
9865-74
9865-77
SIGNET 70B
9869-74
9869-77

RETAIN FOR FUTURE REFERENCE

VEUILLEZ CONSERVER POUR REFERENCE ULTERIEURE

1-800-265-2150

info@omcbbq.com

Onward
SINCE 1906
MANUFACTURING COMPANY LIMITED
585 KUMPF DRIVE
WATERLOO, ONTARIO, CANADA
N2V 1K3

10084-E41 02/06

1

(2)

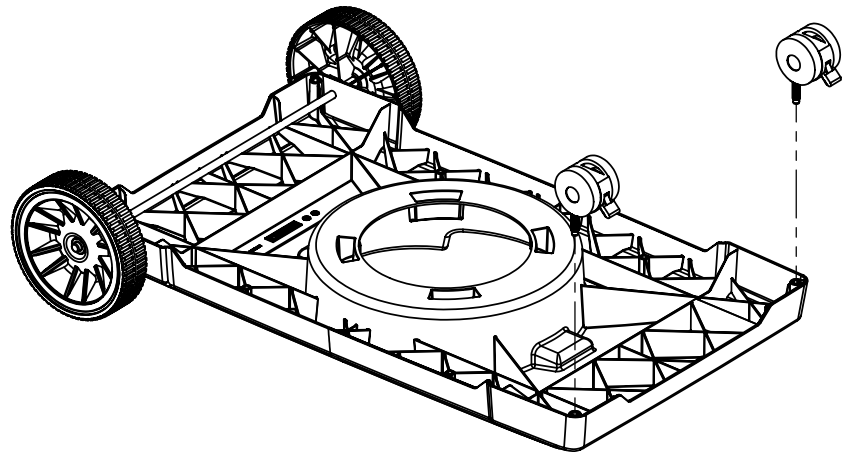
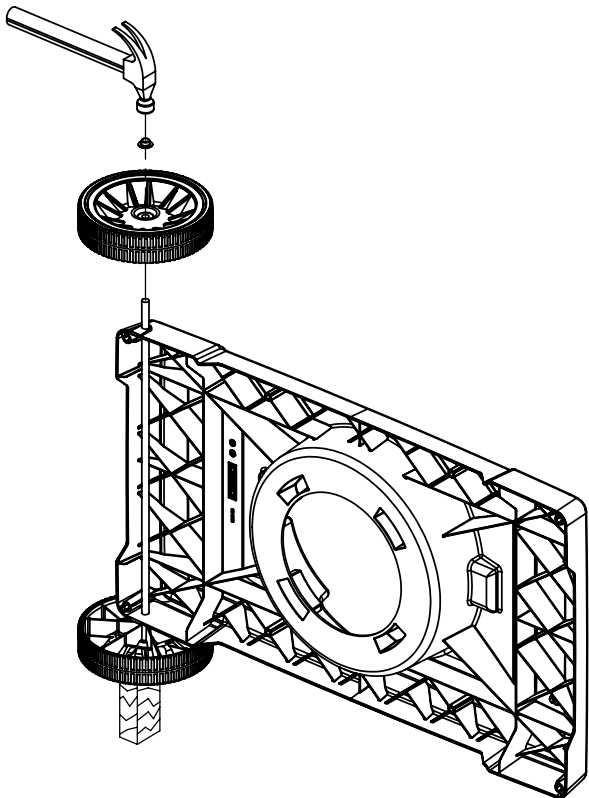
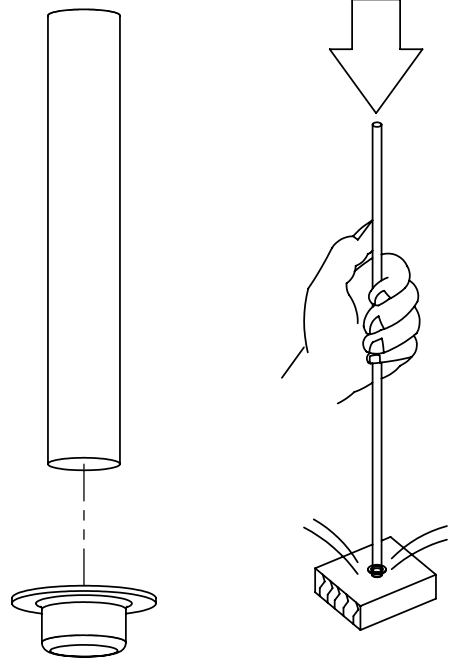
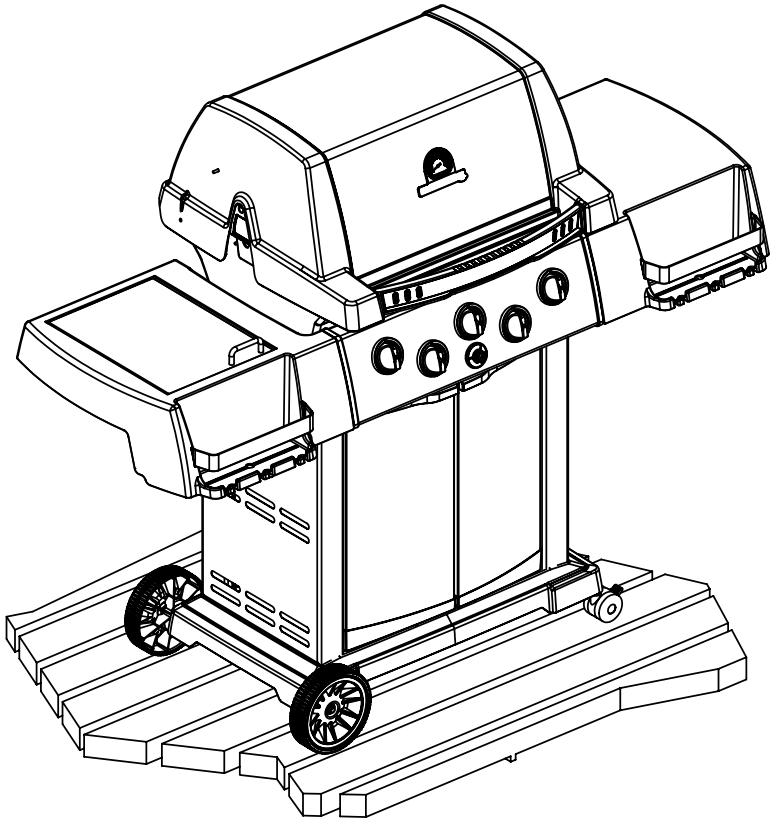
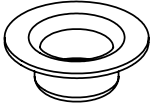

2

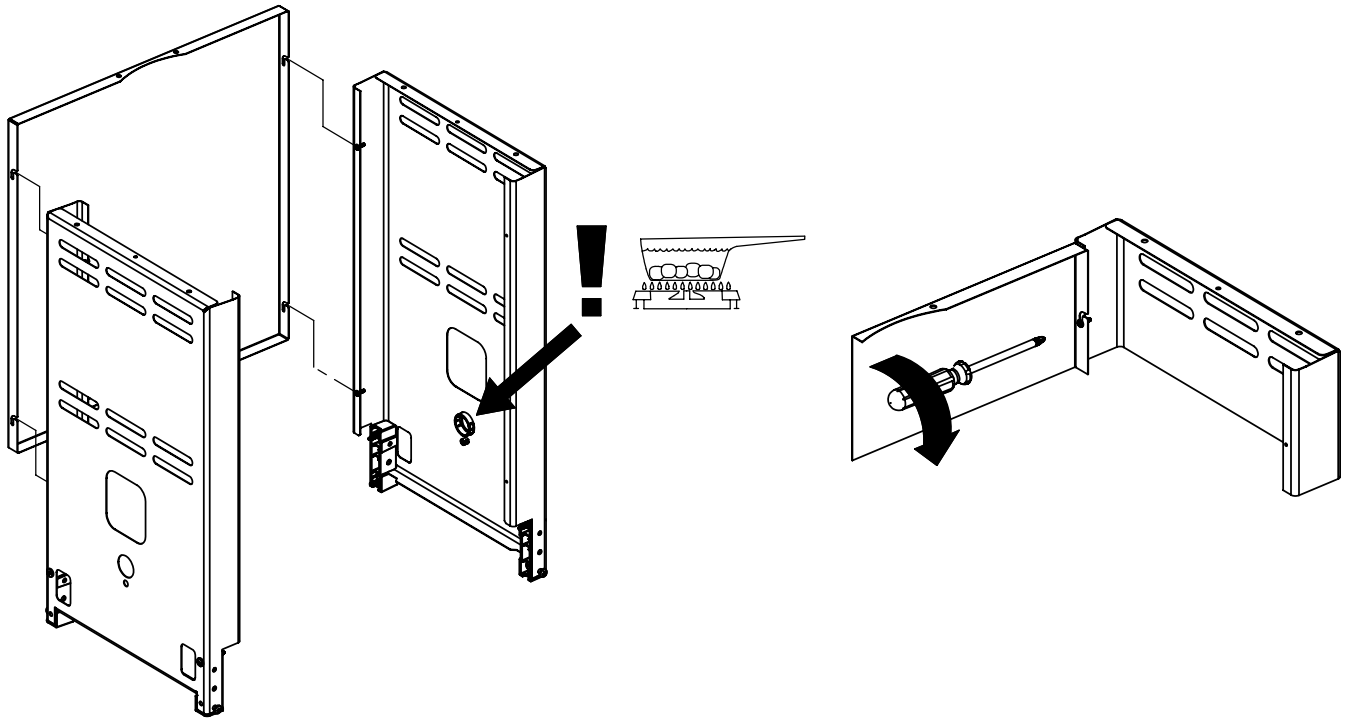

3

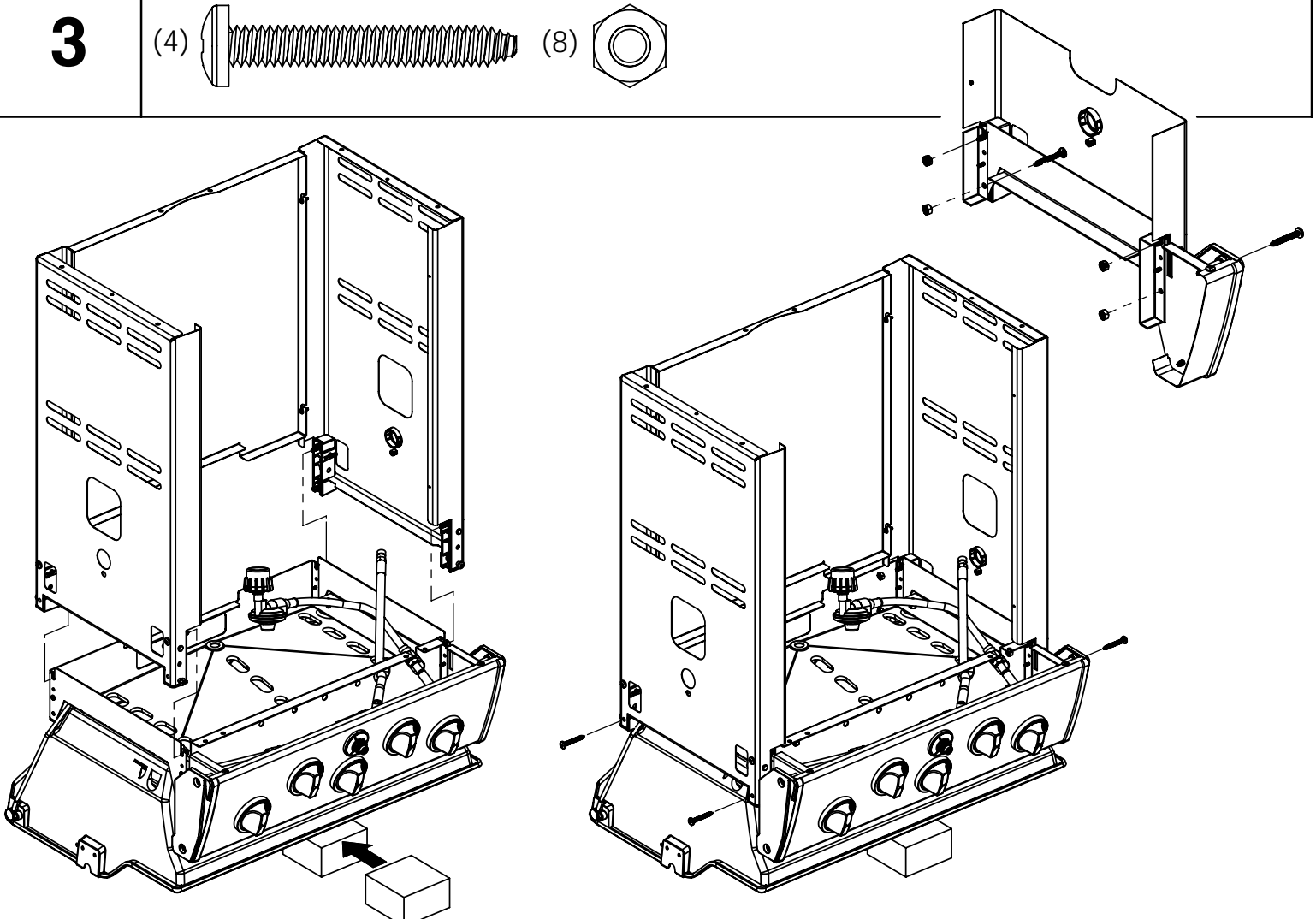
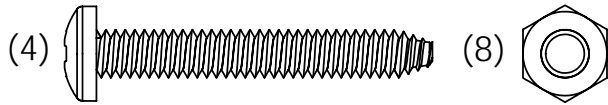

4

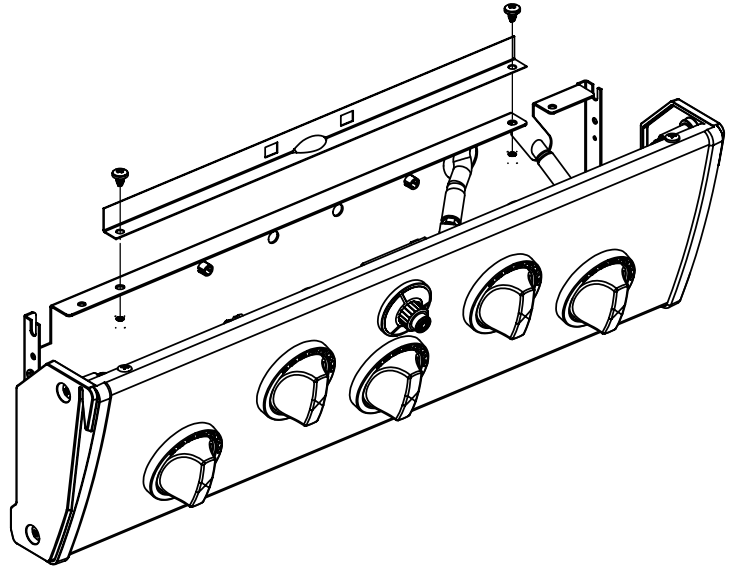
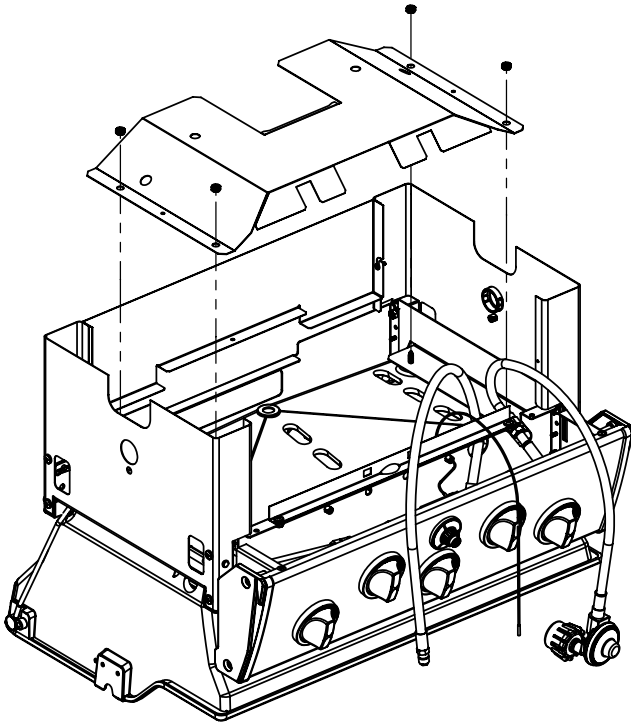
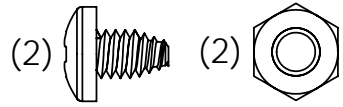
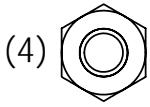

5

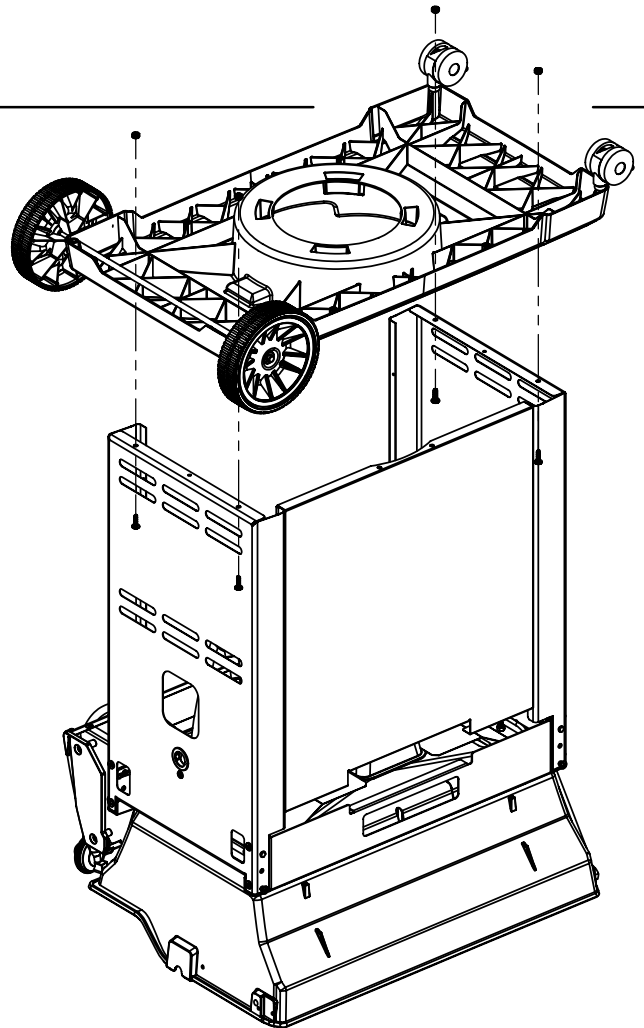
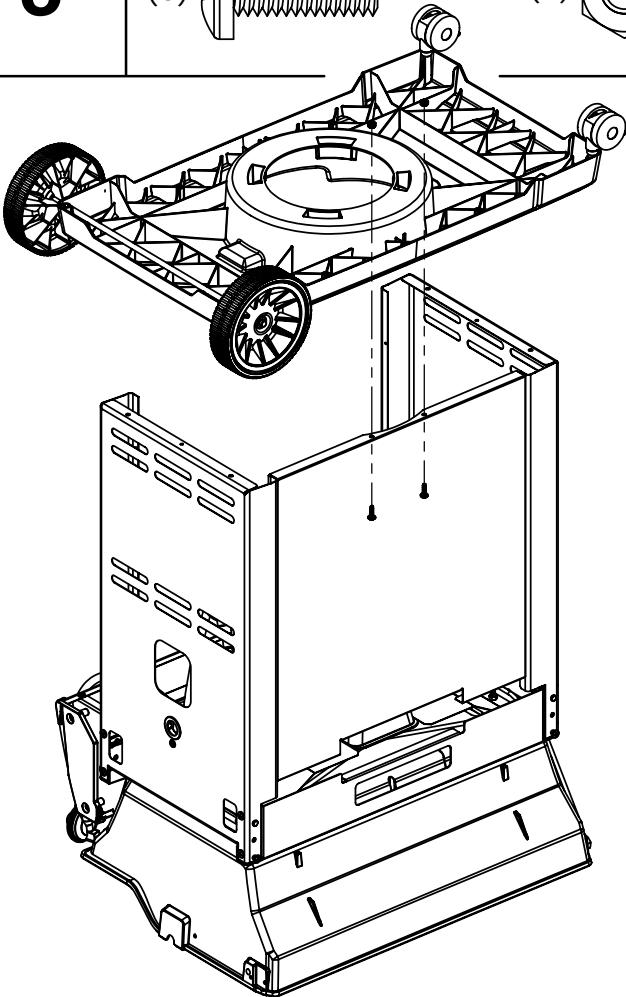
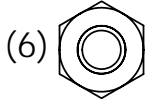
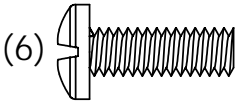

6

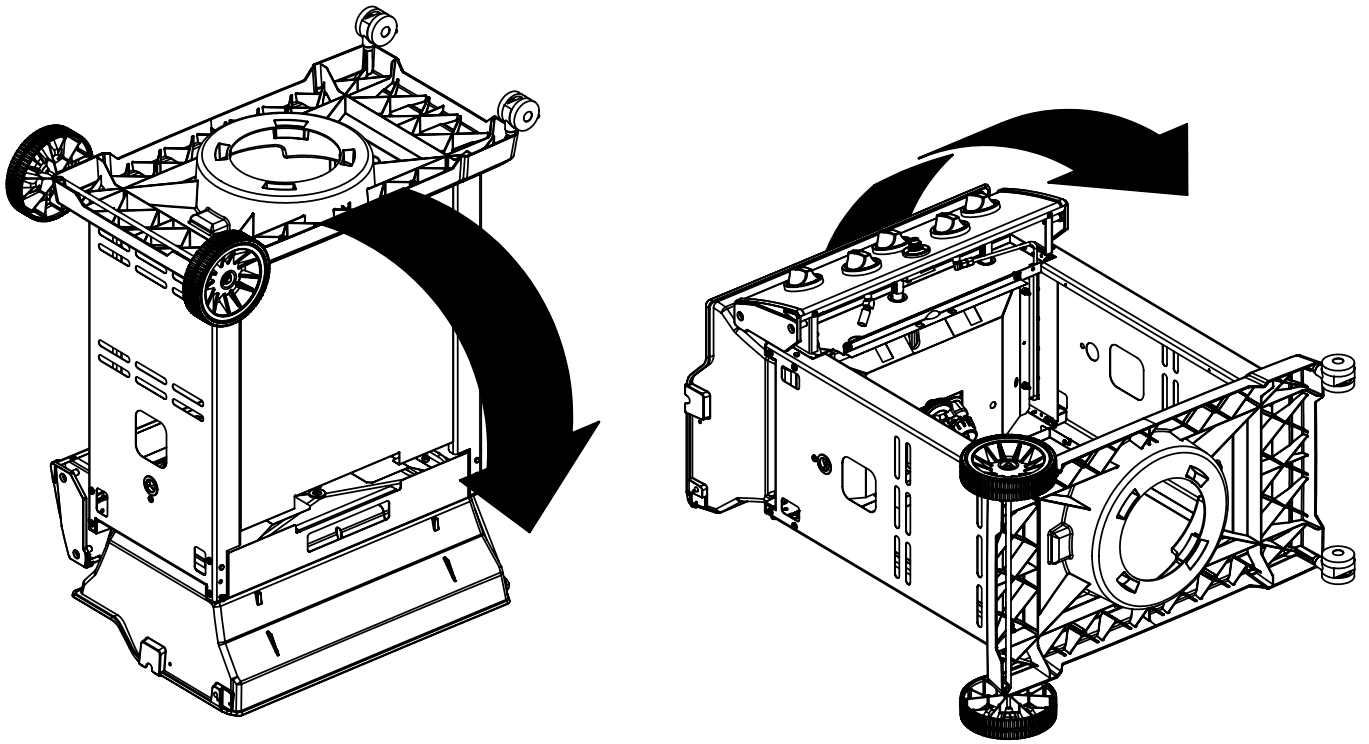

7

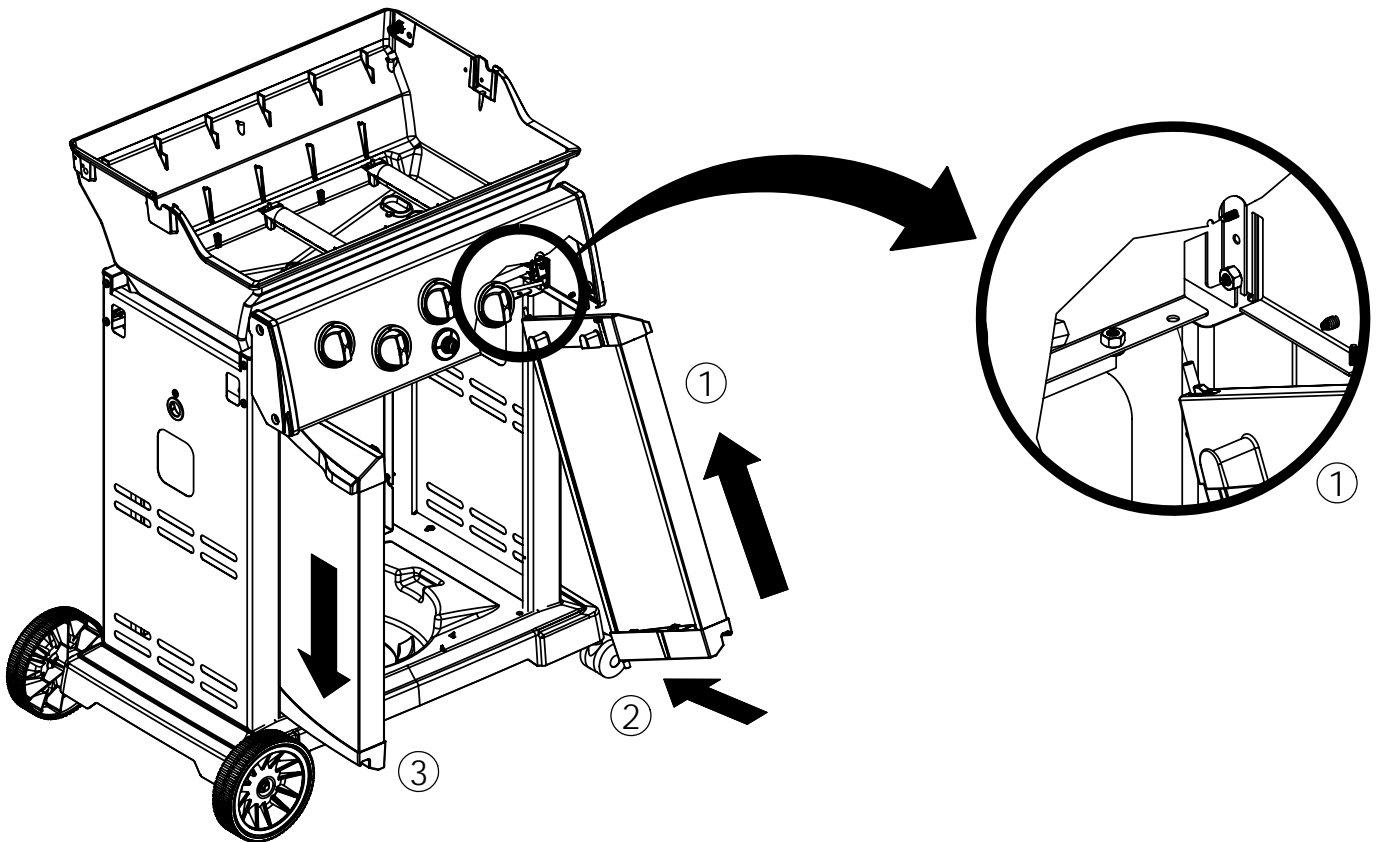

8

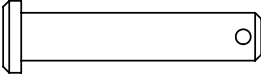
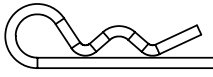
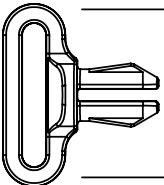
(2)  (2)  (1) 

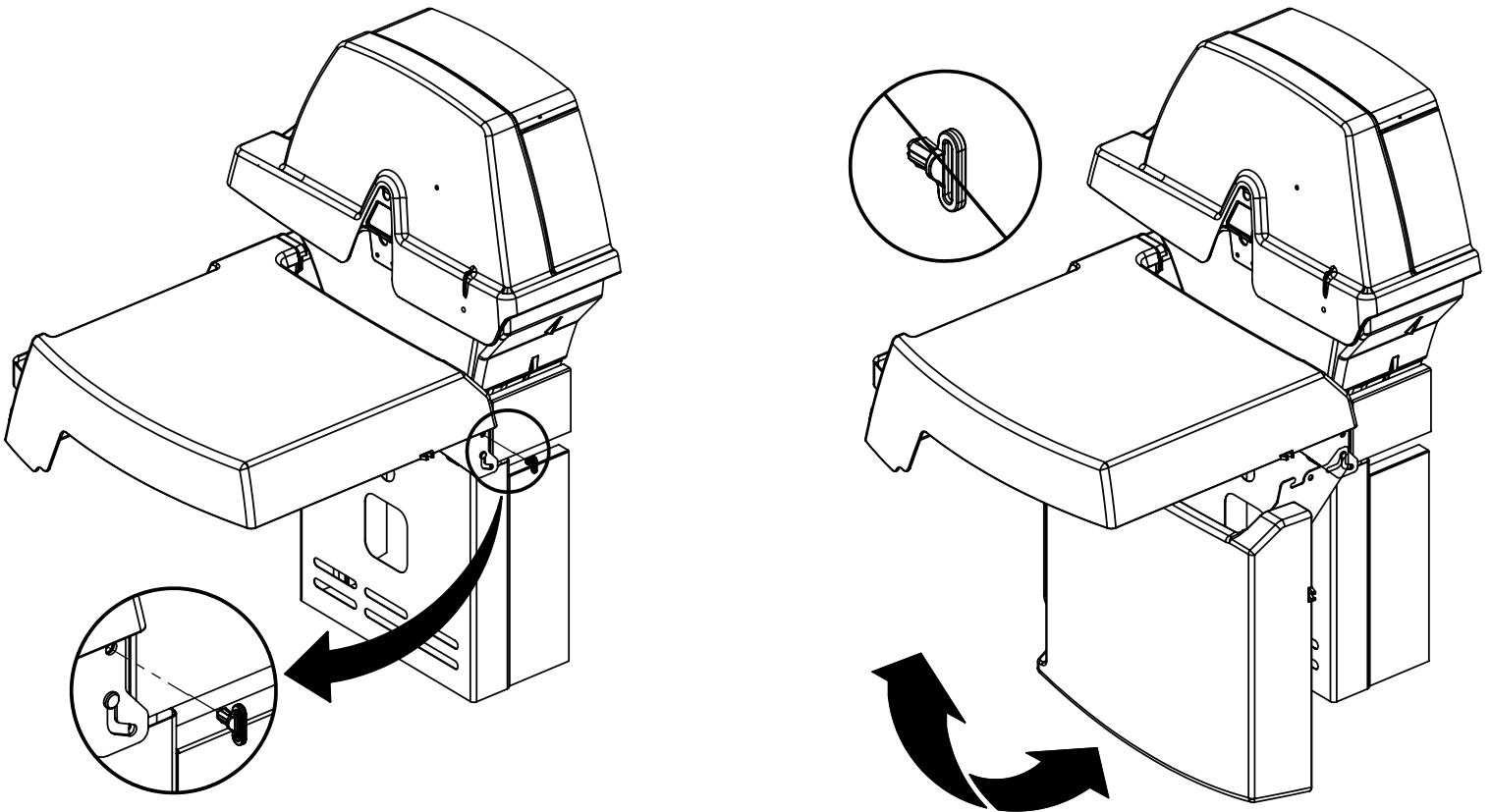
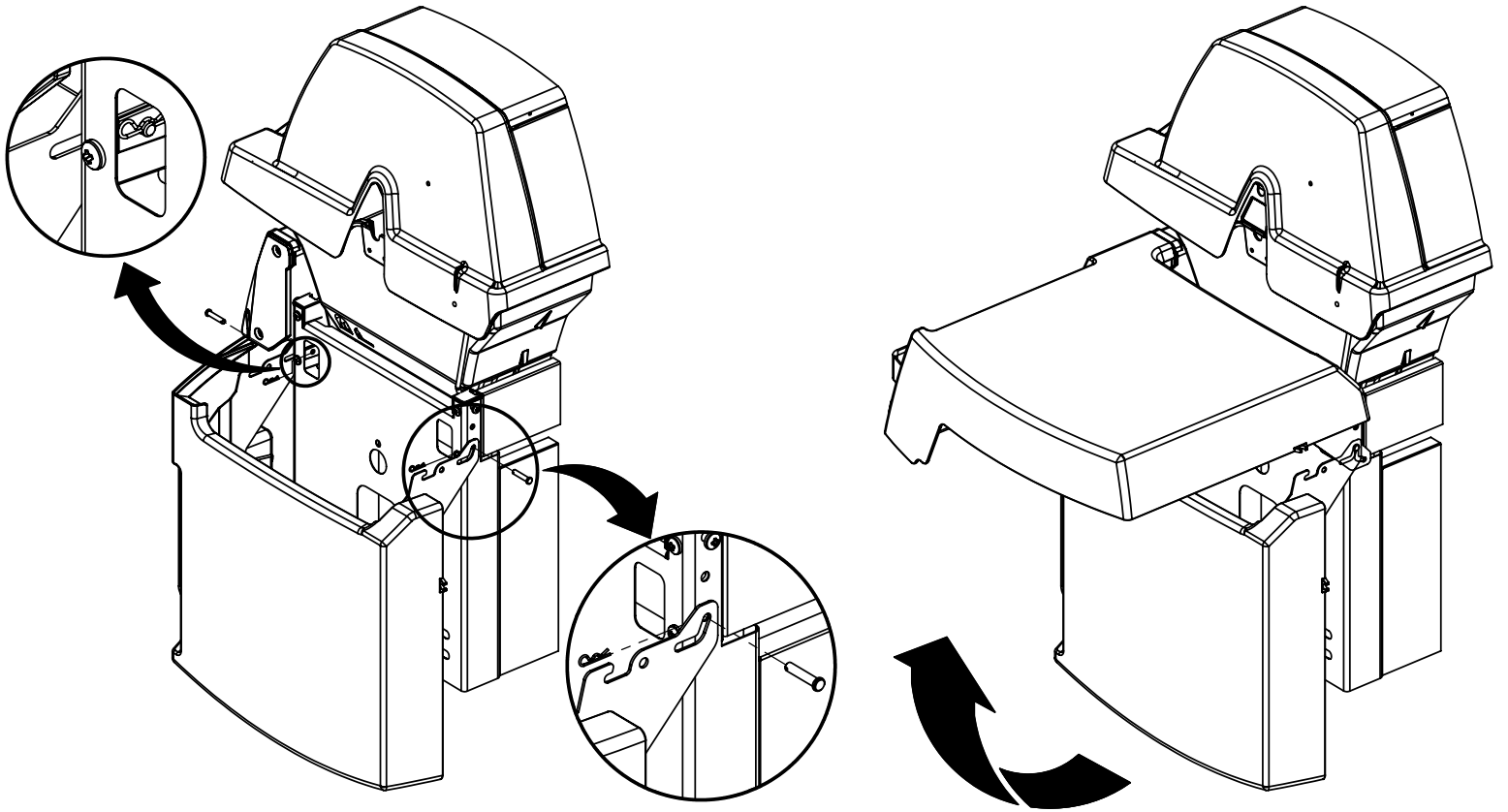

9

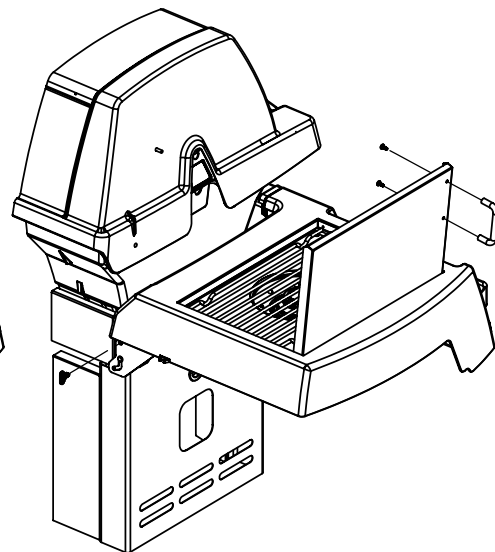
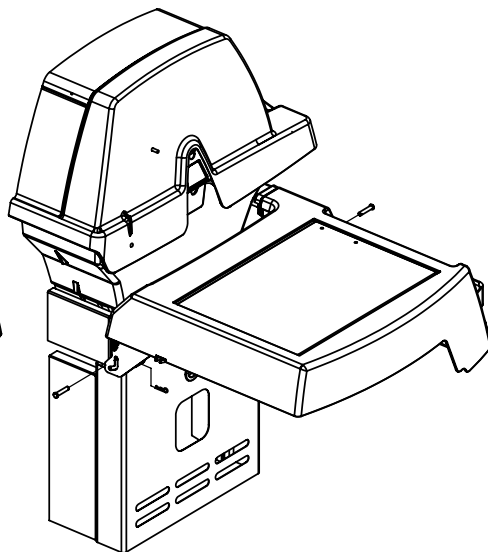
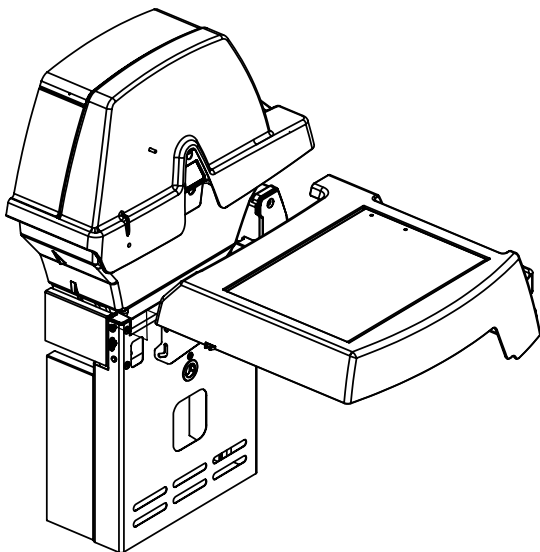
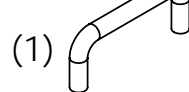
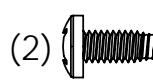
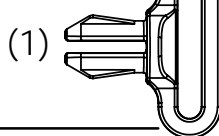
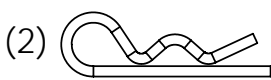
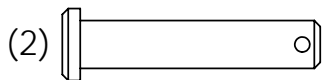

10

(1)

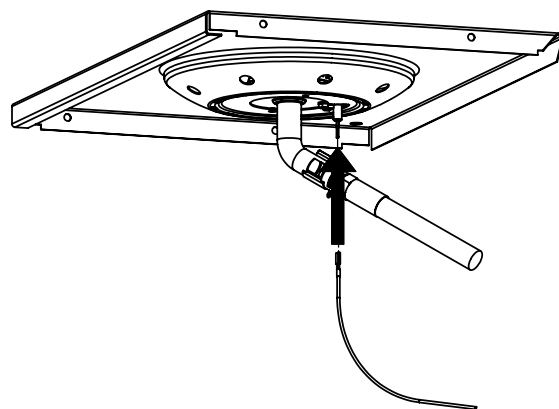
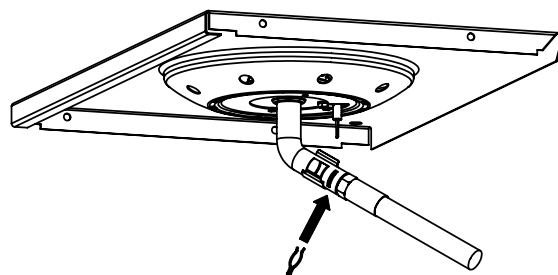
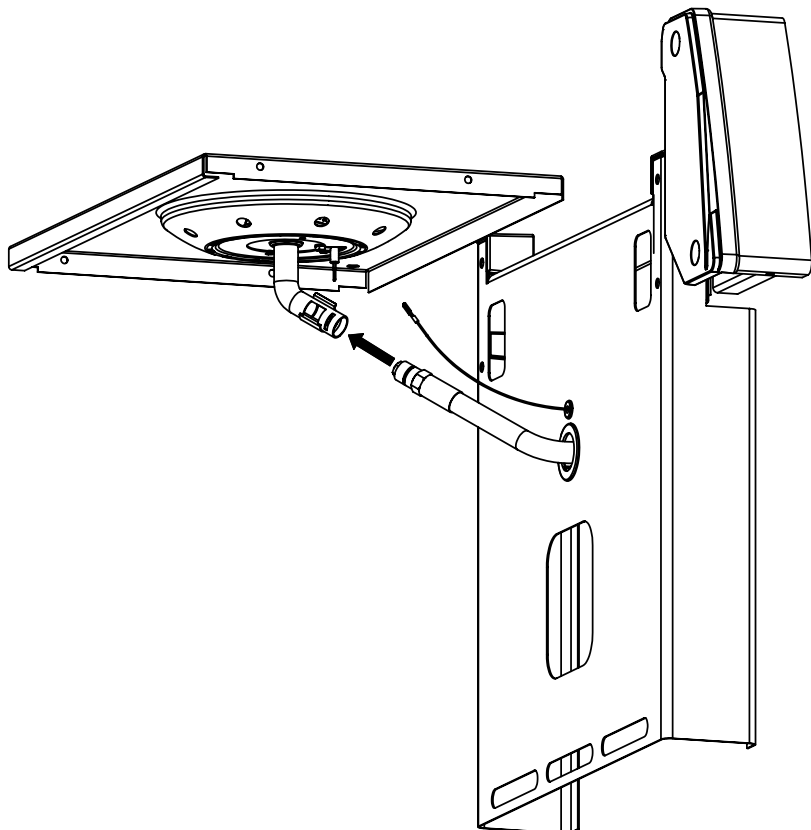
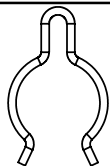

11

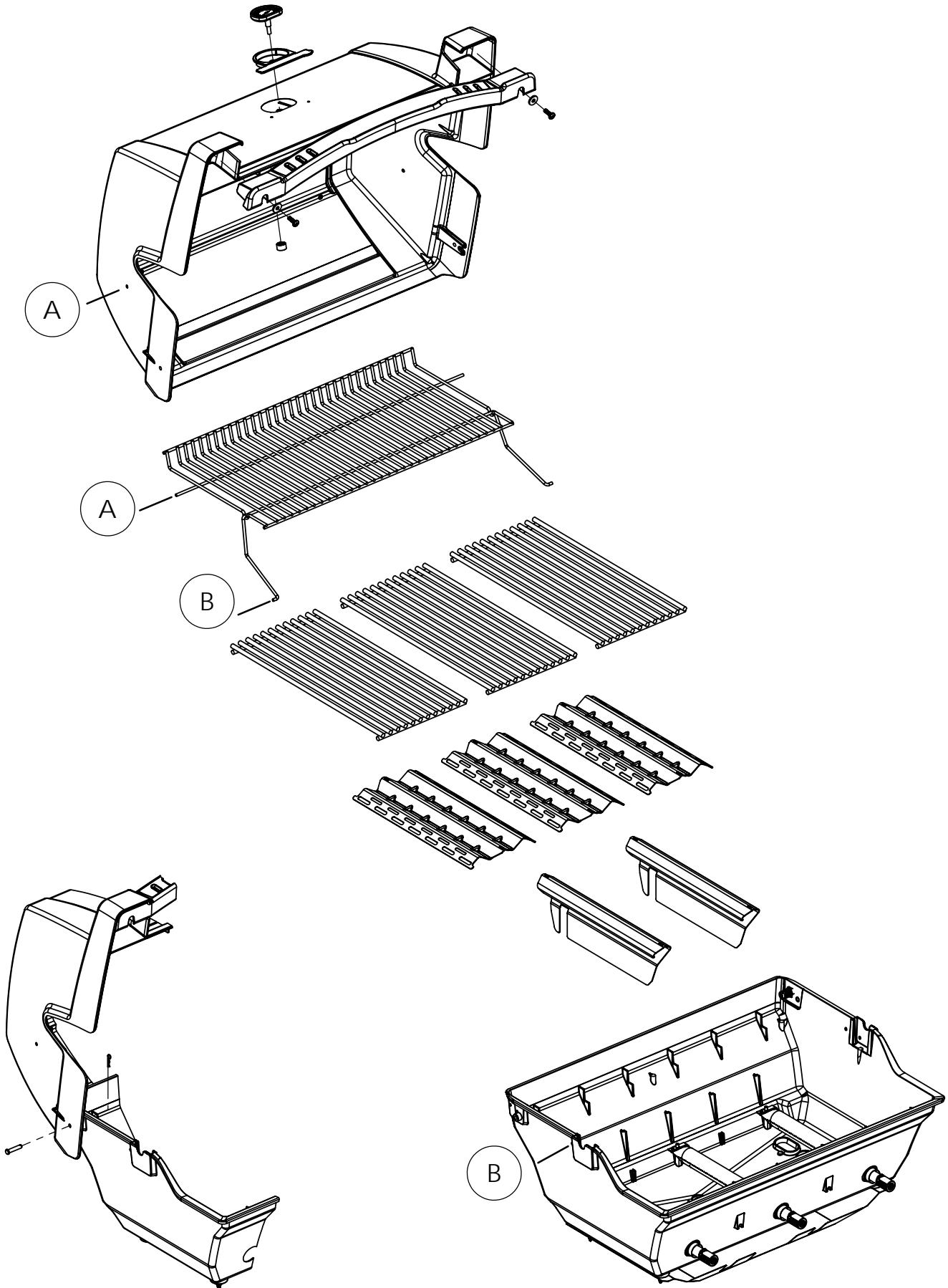
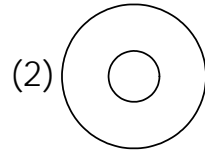
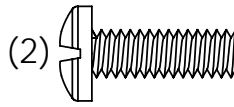
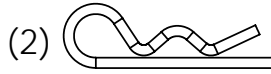
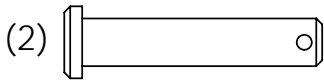

12

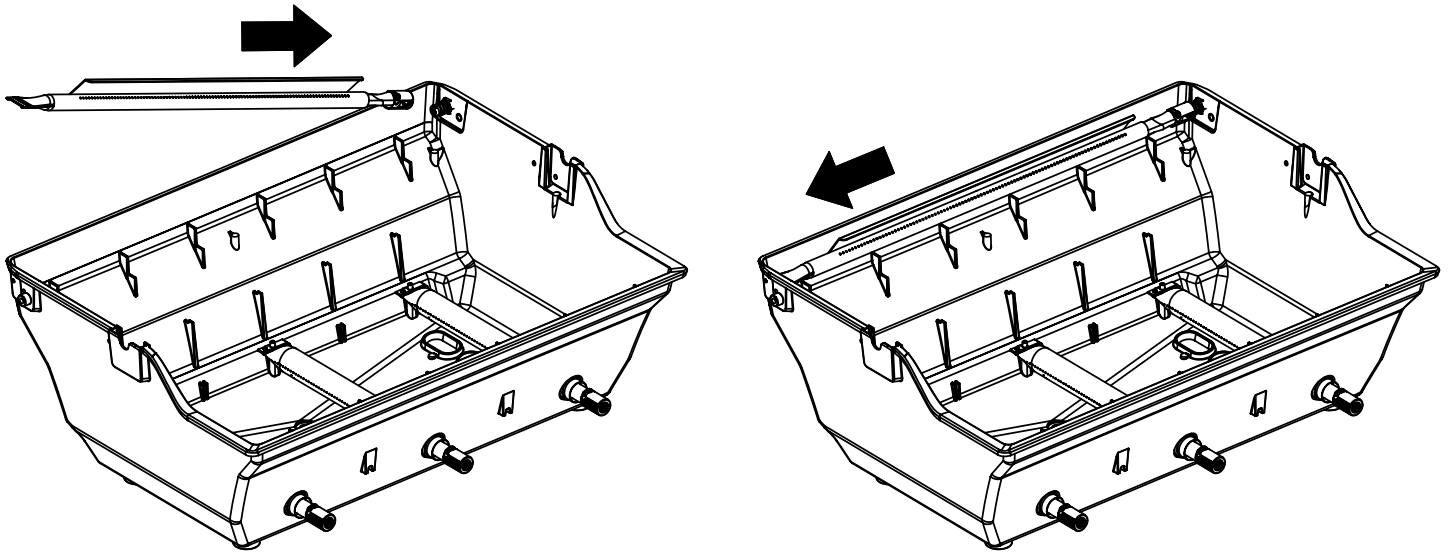

13

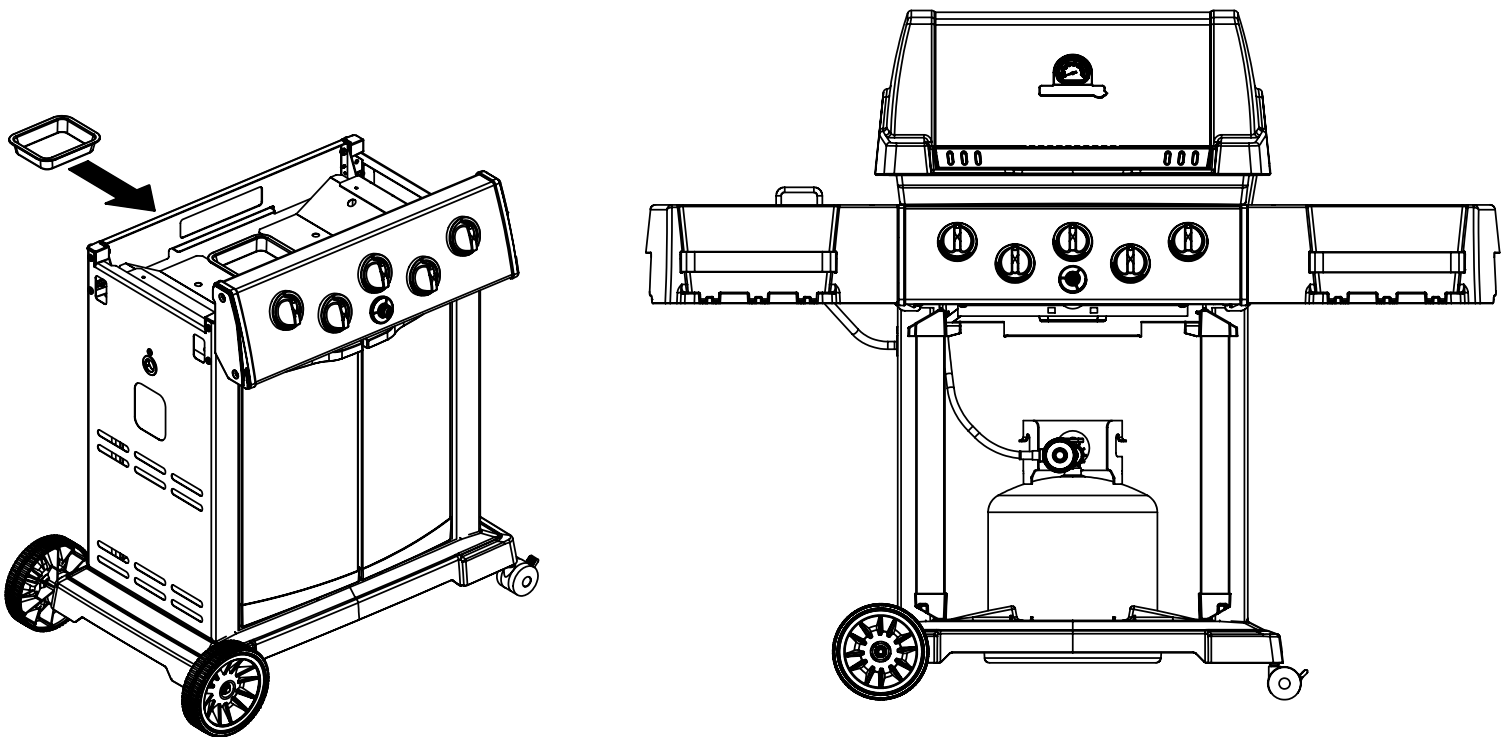

14

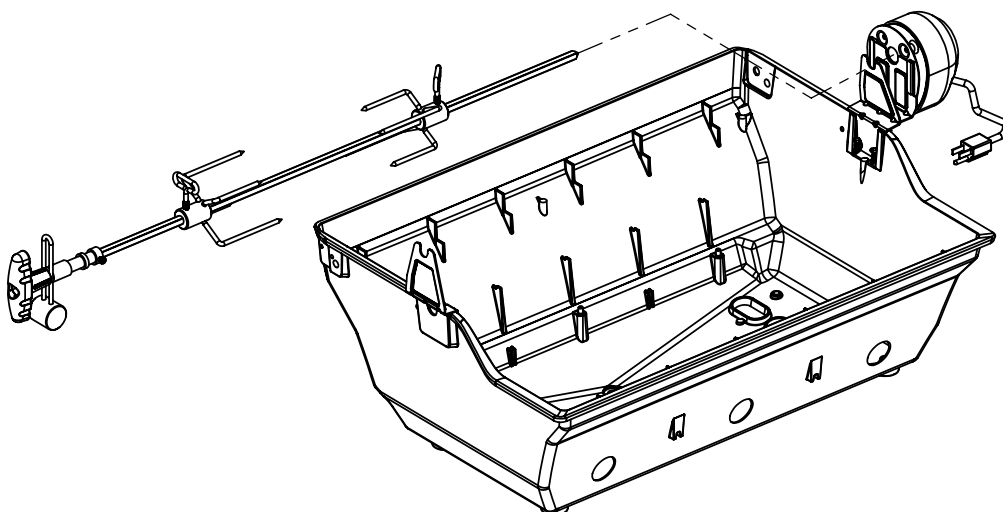
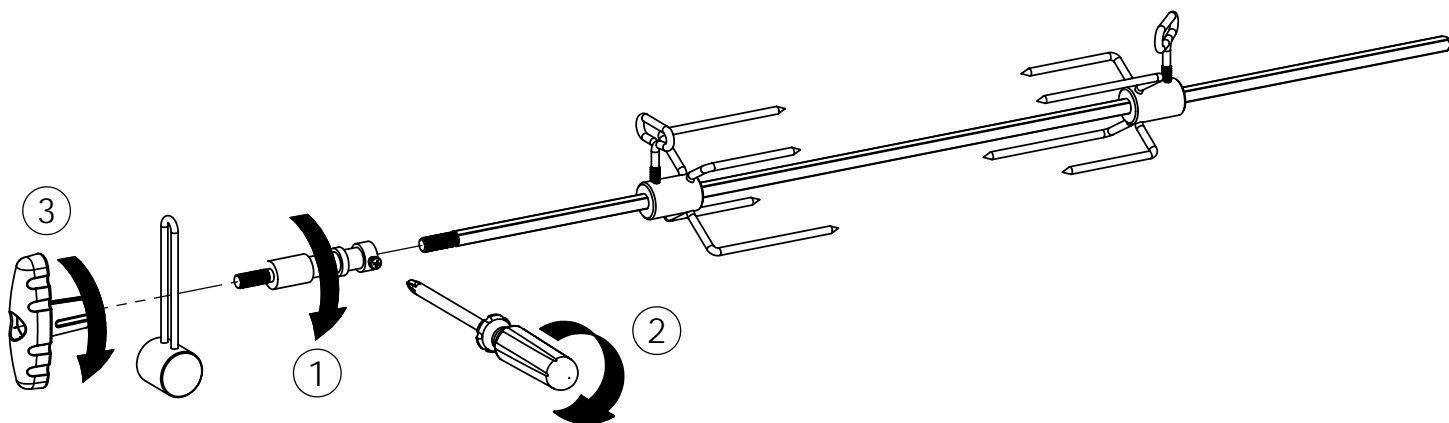
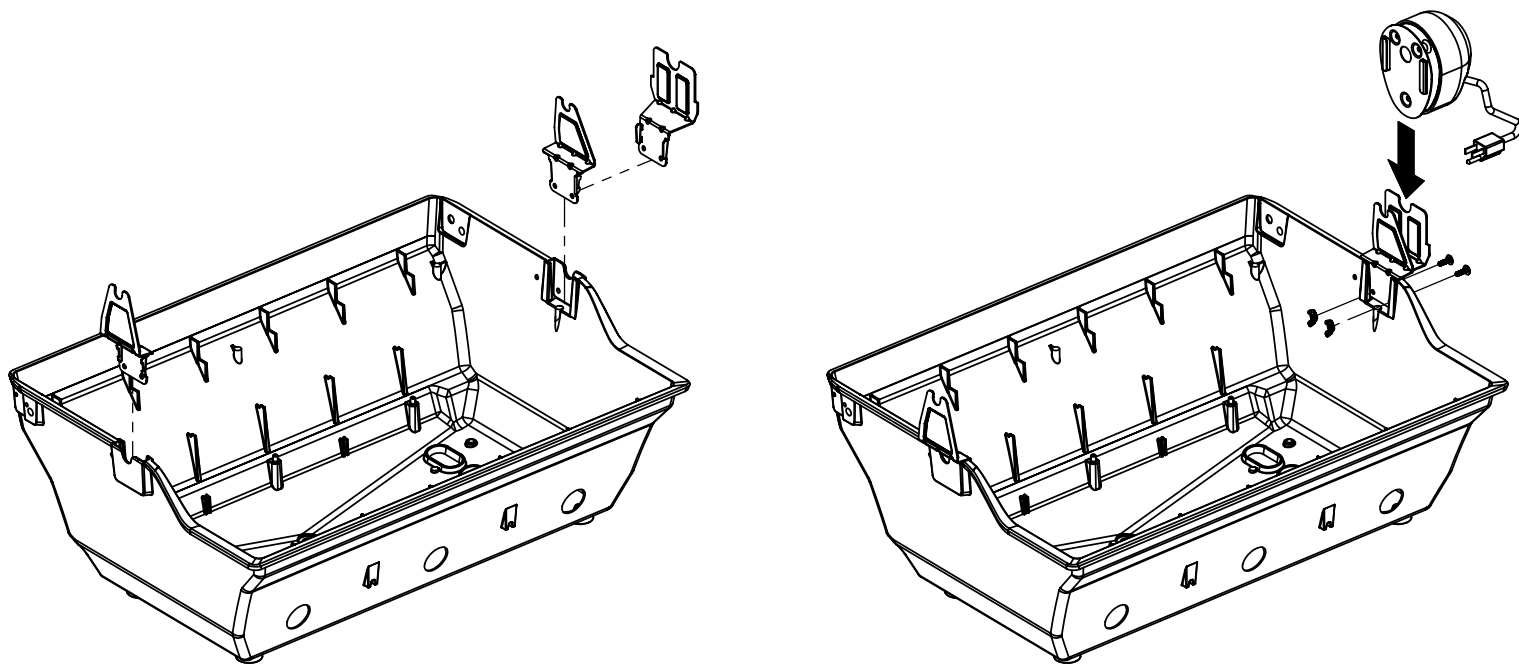
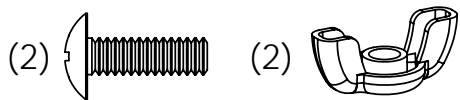

PARTS LIST / LISTE DES PIECES

KEY #	ITEM #	DESCRIPTION	DESCRIPTION	9865-14	9865-24	9865-34	9865-74	9869-54	9869-74	9875-14	9875-24
				9865-17	9865-27	9865-37	9865-77	9869-57	9869-77	9875-17	9875-27
51	10711-E76	SHELF - LEFT	PLANCHETTE - GAUCHE	1	•	1	1	1	1	1	•
	10711-E77	SHELF-SIDEBURNER	PLANCHETTE - BRULEUR DE COTE	•	1	•	•	•	•	•	1
52	10184-E78	DOOR - TOP CAP - LEFT	PORTE - DESSUS - GAUCHE	1	1	1	1	1	1	1	1
53	10184-E76	DOOR - BOTTOM CAP - LEFT	PORTE - DESSOUS - GAUCHE	1	1	1	1	1	1	1	1
54	10184-E79	DOOR - TOP CAP - RIGHT	PORTE - DESSUS - DROIT	1	1	1	1	1	1	1	1
55	10184-E77	DOOR - BOTTOM CAP - RIGHT	PORTE - DESSOUS - DROIT	1	1	1	1	1	1	1	1
56	10892-7	WHEEL	ROUE	2	2	2	2	2	2	2	2
66	S13005	BURNER ROTISSERIE	BRULEUR A ROTISS	•	•	1	1	•	1	•	•
68	S21362	SPRING	RESSORT	•	•	1	1	•	1	•	•
70	Y-11990	HEX NUT	ECROU	•	•	1	1	•	1	•	•
71	10696-109	REARBURNER-ORIFICE LP	ORIFICE DU BRULEUR ARRIERE PL	•	•	1	1	•	1	•	•
	10696-160	REARBURNER-ORIFICE NG	ORIFICE DU BRULEUR ARRIERE GN	•	•	1	1	•	1	•	•
73	S21420	PUSH NUT	POUSSE ECROU	2	2	2	2	2	2	2	2
74	S21084	SCREW - #14 x 3/4	VIS - #14 x 3/4	12	12	12	12	12	12	12	12
75	10338-400	HANDLE	POIGNÉE	1	1	1	1	1	1	1	1
75A	10184-E702	STRAP - HANDLE	COURROIE - POIGNÉE	1	1	1	1	•	•	•	•
	10184-E703	STRAP - HANDLE	COURROIE - POIGNÉE	•	•	•	•	•	•	1	1
	10184-E705	STRAP - HANDLE	COURROIE - POIGNÉE	•	•	•	•	1	1	•	•
76	S21255	WASHER	RONDELLE	2	2	2	2	2	2	2	2
78	10892-15	CASTOR	ROULETTES	2	2	2	2	2	2	2	2
79	Y-11561	BOLT - 1/4:20 x 1 3/4	BOULON - 1/4:20 X 1 3/4	8	8	8	8	8	8	8	8
80	Y-11546	SCREW - 1/4-20 X 5/8	VIS - 1/4-20 X 5/8	4	4	4	4	4	4	4	4
81	Y-11545	SCREW - 1/4-20 X 1 3/8	VIS - 1/4-20 X 1 3/8	4	4	4	4	4	4	4	4
82	Y-12673	SHELF - LOCK PIN	ÉTAGÈRE - GOUPILLE DE SERRURE	2	2	2	2	2	2	2	2
82A	Y-12855	BOLT - 1/4-20 X 3/8	BOULON - 1/4-20 X 3/8	2	2	2	2	2	2	2	2
83	Y-12310	BOLT - 1/4-20 X 3/4	BOULON - 1/4-20 X 3/4	8	8	8	8	8	8	8	8
84	S15170	AXLE	ESSIEU	1	1	1	1	1	1	1	1
87	Y-11793	NUT - 1/4-20	ECROU - 1/4-20	20	20	20	20	20	20	20	20
88	Y-11560	BOLT - 1/4:20 x 1 1/2	BOULON - 1/4:20 X 1 1/2	4	4	4	4	4	4	4	4
96	S21125	SCREW - 8 X 1/2	VIS - 8 X 1/2	4	4	4	4	4	4	4	4
98	S21124	SCREW - 8 X 1/2	VIS - 8 X 1/2	11	12	12	12	11	12	11	12
98A	Y-12643	SCREW - 8 X 1/2	VIS - 8 X 1/2	12	12	12	12	12	12	12	12
99	Y-12646	SCREW - SHOULDER 8 X 1/2	VIS - 8 X 1/2	•	2	•	•	•	•	•	2
104	Y-12835	SCREW - 6-32 X 1/4	VIS - 6-32 X 1/4	•	2	•	•	•	•	•	2
105	Y-29307	NUT - 10-24	ECROU - 10-24	•	4	•	•	•	•	•	4
108	PB20-60	LID HANDLE	POIGNEE	•	1	•	•	•	•	•	1
109	S21136	SCREW - 8-32 X 3/8	VIS - 8-32 X 3/8	•	2	•	•	•	•	•	2
110	10225-T10	GRID	GRILLE	•	1	•	•	•	•	•	1
111	10390-E10	SIDE BURNER	BRULEUR DE COTE	•	1	•	•	•	•	•	1
113	10342-T16	ELECTRODE - SIDE BURNER	ELECTRODE - BRULEUR DE COTE	•	1	•	•	•	•	•	1
114	10393-K40	COVER-SIDE BURNER	COUVERCLE LATÉRAL	•	1	•	•	•	•	•	1
115	Y-29304	SCREW - 10-24 X 3/8	VIS - 10-24 X 3/8	•	4	•	•	•	•	•	4
117	10393-R50	SHELF-SIDE BURNER	SUPPORT DE BRULEUR DE COTE	•	1	•	•	•	•	•	1
123	S15115	GREASE PAN - DISPOSABLE	CUVETTE A GRAISSE	1	1	1	1	1	1	1	1
125	Y-12220	BUSHING	DOUILLE	•	1	•	•	•	•	•	1
135	Y-12119	3/8 HEYCO BUSHING	DOUILLE DE 3/8 HEYCO	2	3	2	2	2	2	2	3
136	10184-E43	ROTISSERIE SHIELD	BOUCLIER DE ROTISSERIE	1	1	1	1	1	1	1	1
137	10184-E42	ROTISSERIE BRACKET	CROCHET DE ROTISSERIE	•	•	1	1	•	1	•	•
138	10184-E44	ROTISSERIE SHIELD	BOUCLIER DE ROTISSERIE	1	1	1	1	1	1	1	1
139	S21061	WING NUT	ECROU PAPILLON	•	•	2	2	•	2	•	•
140	Y-29306	BOLT - 10-24 x 5/8	BOULON - 10-24 x 5/8	•	•	2	2	•	2	•	•
141	S15271	ROTISSERIE HANDLE	POIGNEE DE ROTISSERIE	•	•	1	1	•	1	•	•
142	S15270	ROTISSERIE COUNTER WEIGHT	CONTREPOIDS DE ROTISSERIE	•	•	1	1	•	1	•	•
143	S15279	ROTISSERIE EXTENSION	RALLONGE	•	•	1	1	•	1	•	•
144	S15287	ROTISSERIE FORKS	FOURCHETTE DE ROTISSERIE	•	•	2	2	•	2	•	•
145	S15256	SPIT ROD	BROCHETTE	•	•	1	1	•	1	•	•
146	S15236	ROTISSERIE MOTOR	MOTEUR DE ROTISSERIE	•	•	1	1	•	1	•	•

