

OWNERS MANUAL

LEGACY SERIES GAS GRILLS

BIG SUR SERIES (S48R)

PACIFICA SERIES (S36,S36R & S36T)

NEWPORT SERIES (S27,S27R & S27T)

LP OR NATURAL GAS PORTABLE OR MASONRY

Manual Includes Instruction for PGS Grills with our without TIMERS



Assembly, Operating
& Maintenance Instructions

Revised January 2016



DANGER

If you smell gas:

1. Shut off gas to the appliance.
2. Extinguish any open flame.
3. Open Lid.
4. If odor continues, keep away from the appliance and immediately call your gas supplier or your fire department



WARNING

1. Do not store or use gasoline or other flammable liquids or vapors in the vicinity of this or any other appliance.
2. An LP Cylinder not connected for use shall not be stored in the vicinity of this or any other appliance.

WARNING: Read this Owner's Manual carefully and be sure your grill has been properly assembled, installed and maintained. Failure to follow these instructions could result in serious bodily injury and/or property damage. This grill is intended for outdoor use only and is not to be installed in or on recreational vehicles or boats. **Grill Head must maintain 30" clearance from any combustible materials on all sides with no combustible materials above, do not install in combustible enclosure. Do not obstruct flow of combustion and ventilation air. Keep ventilation openings on cart or island free from obstruction or debris.**

NOTE TO INSTALLER: Leave this Owner's Manual with the consumer after delivery and/or installation.

NOTE TO CONSUMER: Leave this Owner's Manual in a convenient place for future reference. Nuts, bolts and fittings may become loose during transit, so for your own safety, thoroughly inspect every nut, bolt and connection and secure as necessary before using your new grill.

IMPORTANT SAFETY NOTE: This grill is manufactured to exact specifications for the type of fuel marked on the outside carton, as well as noted on the rating plate found on the grease tray. Conversion from one fuel type to the other fuel type should only be done by a qualified gas technician.

PGS GRILLS by AEI CORPORATION
2641 Du Bridge Ave.
P. O. BOX 16097
IRVINE, CA 92623-6097
PH (949) 474-3070 FAX (949) 474-0559



Intertek



CONGRATULATIONS! You have purchased a truly exceptional outdoor cooking appliance with your Legacy Series grill from PGS. Your outdoor gas grill has been designed and constructed to give you many years of outdoor cooking enjoyment. All PGS grills are designed with quality, dependability, performance and safety features not found in any other gas grills.

Please read this manual from cover to cover. It will provide great information on the assembly, care, maintenance and most important safe use of your "outdoor grilling machine".

Your grill will become one of the most versatile, exciting, and often used appliances that you own! We would like to thank you for selecting one of our fine products. If we can be of any help or can answer any questions please do not hesitate to contact us. We also welcome any and all comments you might have about your grill and how we might improve it in the future.

Bon Appetit!

George Speicher
President

Pete Arnold
Vice President

Please note: We have made our catalogs, specification sheets, and other materials relating to our fine line of outdoor cooking products as comprehensive and accurate as possible. We are constantly trying to improve all aspects of our products and therefore, reserve the right to make changes in them at anytime, without notice. Because product improvements may have been made since the time our materials were printed, please check with your Authorized PGS Dealer or Distributor if you have any specific questions concerning our products. AEI is dedicated to producing the finest leisure gas appliances for the home.

TABLE OF CONTENTS

Recap of Safety Tips, Warnings and Recommendations.....	Page 4 & 5
Grill Model Identification	Page 6
Liquid Propane Gas Safety, Connections, Handling and Storage	Page 6 & 7
Natural Gas Pressure Requirements	Page 7
Location of Grill/Clearances from Combustibles	Page 8
Assembly Instructions and Connection to Gas Supply (L.P. and Natural Gas).....	Page 8 & 9
Orifice Engagement.....	Page 9
Propane Cylinder Connection.....	Page 10
Leak Tests	Page 10
Lighting Your Grill.....	Page 10
If Grill Fails to Light	Page 10
Burner and Electrode Adjustment	Page 10
Grease Tray Clean Out.....	Page 10
Periodic Cleaning.....	Page 10 & 11
Flare-Ups.....	Page 11
Flash Back (Spider Fires).....	Page 11
Gas Grill Conversion	Page 11
Troubleshooting	Page 11, 12, 14 (Timer)
Care of Stainless Steel	Page 12
Masonry Cut Out Dimensions.....	Page 12 & 13
Infra Broil Rear Burner Use	Page 13
Flame Adjustment	Page 13 & 14
Grill Cover	Page 14
Replacement Parts.....	Page 14
Timer Troubleshooting	Page 14
T SERIES GRILLS (equipped with built-in one hour gas flow timers)	Page 15
COOKING TIPS AND TIMES.....	Page 16
Beef Cooking Guide	Page 20
Poultry Cooking Guide.....	Page 21
Warranty Information	Page 22
Warranty Registration Card	Page 24
Parts Diagram	Page 26
Part Numbers.....	Page 27

VERY IMPORTANT SAFETY TIPS AND WARNINGS

At PGS, we are most concerned about the safe use of our product. The following two pages are a summarization of the safety tips found throughout this manual. Please take the time to review them, as they are critical in the enjoyable and safe use of your grill. Improper assembly, neglect, use or insufficient care of your PGS gas grill may result in serious bodily injury and/or property damage.



GIVE THIS SYMBOL SPECIAL ATTENTION THROUGHOUT THIS MANUAL. IT NOTES SAFETY RELATED ITEMS OR PRODUCT WARNINGS

- Our grills are tested in accordance with ANSI Z21.58 Issued 2007 Standard for Outdoor Gas Cooking Appliances. Check your local building codes for the proper methods of installation.

In the absence of local codes, this grill should be installed in compliance with either the *National Fuel Gas Code, ANSI Z223.1/NFPA54, Natural Gas and Propane Installation Code, CSA B149.1, or Propane Store and Handling Code, B149.2.* **GAS GRILLS ARE NOT FOR USE ON RECREATIONAL**

VEHICLES, PORTABLE TRAILERS, BOATS OR ANY OTHER MOVING INSTALLATION.

- **CALIFORNIA PROPOSITION 65 WARNING:** The burning of gas cooking fuel generates some by-products which are on the list of substances which are known by the State of California to cause cancer or reproductive harm. California law requires that businesses warn consumers of potential exposure to such substances. To minimize exposure to these substances, always operate this gas grill according to the use and care instructions found in this manual. Be certain to provide adequate ventilation when cooking.
- **WARNING: Do not try to light this appliance without first reading the "LIGHTING INSTRUCTIONS" section of this manual found on page 11.**
- **Inspect hose before each use of appliance, if signs of wear replace before operating. If it is evident there is excessive abrasion or wear, or the hose is cut, it must be replaced prior to the outdoor cooking appliance being put into operation. USE only OEM replacement.**
- Do not modify original equipment. Your grill has been designed and engineered to operate as outlined in this manual. Only replace components with Genuine PGS Replacement Parts, which are available from your local dealer and/or distributor. Use of non-genuine parts may result in inferior performance and or safety hazards and may void the warranty.
- Children should not be left alone or unattended in an area where the grill is in operation. We suggest placement of your grill to be well away from areas where children play. Do not store items that may interest children in or around the grill, in the cart, or in the masonry enclosure. Never allow children to crawl or play inside a masonry enclosure.
- **NEVER STORE ADDITIONAL OR EMPTY PROPANE CYLINDERS IN GRILL CABINET OR AROUND THE GRILL. DO NOT STORE A PROPANE CYLINDER INDOORS OR ON ITS SIDE. NEVER ALLOW A PROPANE CYLINDER TO BE FILLED OVER 80% FULL. Never use dented, rusty or damaged propane cylinder. Never replace the tank, regulator or hose safety fittings on the grill with any other connections. If above information is not exactly followed, a fire causing death or serious injury may occur.**
- Never store pool chemicals or other flammable materials in any cabinet below or near the grill. Never allow loose clothing, potholders, synthetic materials, or other flammable materials to come in contact with the grill and/or its parts. Flammable materials could ignite and cause personal injury and/or property damage. Do not heat up unopened food containers on grill as a buildup of pressure may cause the container to burst.

VERY IMPORTANT SAFETY TIPS AND WARNINGS CONTINUED

- Never move your gas grill when operating. Never move grill when HOT.
- Use an insulated glove when opening and operating the grill. Open grill lid slowly to allow heat and smoke to escape before fully opening.
- Never lean over hot grill surface or look directly into grill when attempting to light. The grill hood must be opened fully when lighting. Be sure that all family members are aware of safe lighting and operating procedures of grill.
- If a professional installer or a dealer installs grill, be sure that he shows you where your gas supply shut off is located. All gas lines must have a shut off that is readily and easily accessible. If you smell gas, check for gas leaks immediately. Check only with a soap and water solution. **Never check for gas leaks with an open flame.**
- Never use charcoal, volcanic rock, wood chip materials, or non-PGS briquettes in your grill.
- Keep the optional rotisserie motor and electrical supply cord away from heated casting, cooking grids, other hot parts or water. Store rotisserie motor and parts in a dry place.
- Never use grill in a windy area and never use the grill during an extremely windy day. Climatic conditions will impact the performance of the grill. In consistently windy conditions, we suggest installing a suitable windbreak, if at all possible.
- **Always adhere to the required clearances from combustibles. THE GRILL IS DESIGNED FOR USE OUTDOORS ONLY; never operate grill in garage, buildings, shed, breezeways or other enclosed areas.**
- Store your grill in a well-vented area with gas supply OFF. If grill is stored INDOORS, LP cylinder MUST be removed, if equipped with one, and store it outdoors in a well-ventilated area away from heat and where children may possibly tamper with it.
- When using the optional side burner kit, use pots that have flat bottoms and are large enough to cover entire burner. Adjust the flame so that it only heats the bottom of the pot or pan to avoid the possible lighting of clothing. Position handle in a way that it does not conflict with the opening and closing of grill lid.
- Grease is extremely flammable. Let hot grease cool down before attempting to handle or dispose of. **Clean out your grease tray on a regular basis.**
- Never cover cooking grid with a material that will trap heat beneath cooking grids such as large pans or aluminum foil. Heat reflected below may cause damage to rock grates, burners, gas valve assembly and possibly to gas train. You need only to "Pre-Heat" your grill five to seven minutes before cooking. You do not need to "Burn-Off" your gas grill for extended times after use.
- If left uncovered, grease tray will accumulate water if grill left in the rain or snow. Empty accumulated water before using grill.

Please refer to specific sections of this manual if you have questions regarding different types of fuels, lighting, or trouble-shooting. If you have questions that are not answered in this manual, please call your local dealer or AEI Corporation.



PLEASE NOTE THIS SYMBOL IT DEALS WITH PRODUCT SAFETY ISSUES AND WARNINGS

IT IS YOUR RESPONSIBILITY TO: ASSEMBLE, INSTALL, LEAK CHECK, CARE AND OPERATE YOUR GAS GRILL. SAVE INSTRUCTIONS FOR FUTURE REFERENCE.

FOR YOUR SAFETY IF YOU SMELL GAS:

1. **SHUT OFF GAS TO THE APPLIANCE.**
2. **EXTINGUISH ANY OPEN FLAME.**
3. **OPEN LID.**
4. **IF ODOR CONTINUES, IMMEDIATELY CALL YOUR GAS SUPPLIER.**

THIS GAS GRILL IS DESIGNED FOR OUTDOOR USE ONLY

FOR YOUR SAFETY

KEEP AREA CLEAR FROM ANY COMBUSTIBLES. DO NOT STORE OR USE GASOLINE OR OTHER FLAMMABLE VAPORS AND LIQUIDS IN THE VICINITY OF THIS APPLIANCE.

THIS GRILL IS NOT INTENDED FOR USE ON A BOAT OR RECREATIONAL VEHICLE.

STORE THE LP GAS (PROPANE) CYLINDER OUTDOORS IN A WELL-VENTILATED SPACE. DO NOT STORE A PROPANE GAS CYLINDER IN DIRECT SUNLIGHT. DO NOT STORE EXTRA CYLINDERS IN CART OR NEAR GRILL. DO NOT STORE PROPANE CYLINDER ON SIDE.



Teflon tape or pipe joint compound will be required on all steel pipe connections. Never use a sealer when your connection is brass to brass. Brass to brass is self-sealing.

The grill itself is partially assembled, with the burner, venturi, ignitor, collector box, and ignitor lead wire installed. Take your time in assembly. Please read instructions thoroughly before starting assembly.

This manual is based on information available when the manual was printed. Continued improvements in design could cause changes in the grill that may or may not be included herein.

Please consult your authorized PGS dealer if you have any questions concerning assembly, installation or operation of your grill.

PLEASE RETAIN INSTRUCTIONS FOR FUTURE REFERENCE, TAKE THE TIME NOW TO RECORD THE MODEL AND SERIAL NUMBERS HERE. PLEASE RETURN OWNER REGISTRATION CARD IMMEDIATELY. RETURN OF WARRANTY CARD INSURES WARRANTY REGISTRATION.

MODEL IDENTIFICATION

A model number identifies your PGS Grill and a serial number located on the stainless steel grease tray that is included in your grill head. Always use both the model number and the serial number when calling or writing AEI CORPORATION about your grill.

UPON UNBOXING YOUR GRILL, PLEASE NOTE THE FOLLOWING:

MODEL NUMBER _____

TYPE OF GAS _____ NAT GAS _____ PROPANE

SERIAL NUMBER _____

DATE PURCHASED _____

DEALER NAME _____

CITY, STATE _____

PLEASE RETURN REGISTRATION CARD TODAY

SAFETY

YOUR GRILL IS DESIGNED FOR OUTDOOR USE ONLY. Please thoroughly review all safety statements recapped on pages four and five on this manual and found throughout.



The grill must be located no closer than 30" from any combustible material below, behind or to the sides. The grill should not be located under overhead combustible materials.

Keep the area around the grill clear of combustible materials, flammable vapors or liquids such as gasoline. The grill surfaces become very hot during use. Keep children and pets away. Use hot pads or oven mitts.

GAS

Both natural gas (NG) and propane gas (LP) have a long history of safe use, when simple rules are followed. If not, there is danger of fire or explosion.

Check Local Codes. Consult your local LP dealer or Natural Gas Company listed in your local directory for recommended installation procedures and regulations. In the absence of local codes, installation must conform to the National Fuel Gas Code, ANSI Z233.1.

NEVER USE NATURAL GAS IN A UNIT DESIGNED FOR LIQUID PROPANE OR THE REVERSE. IF YOU WISH TO CONVERT YOUR GRILL FROM ONE TYPE OF GAS TO THE OTHER, PLEASE CONTACT YOUR LOCAL DEALER, DISTRIBUTOR, OR AEI CORP.



Never connect an unregulated propane gas cylinder or unregulated natural gas to your gas grill (Note: most homes equipped with natural gas have a regulator near the gas meter).

SAFETY INFORMATION OF PROPANE MODELS

Your PGS grill is designed to operate on propane gas regulated at a gas pressure of 11" water column (W.C.) (2.7kPa). If you are hooking your grill into "System LP" which fuels your home, please be certain that you are at this pressure.



Operating your grill at pressure higher or lower than recommended may damage the grill or result in a hazard or poor performance.

A regulator adjusted to this pressure must be installed in the gas supply line before the grill is connected to the propane source. PGS propane gas grills include a 11" W.C. regulator and a "TYPE I" Cylinder Connection Device. This system complies with the specifications and requirements of ANSI Z21.58b standards. This system can only be used with a QCC Type I tank. Our hoses include an excess flow safety system that will stop the flow of gas to your grill in the event of leaking gas or a damaged hose.



PLEASE NOTE. In the event that you inadvertently have the valves of your grill turned to the "ON" position, and then open the valve on top of your tank, the excess flow device will activate and shut off the flow of gas. If this should occur, turn the valves to the "OFF" position on your grill head then the valve on the tank "OFF". Wait five minutes

before attempting to light. Always turn on the valve at the top of your tank and then the valves to your grill head to the "ON" position. The safety system detailed above has been incorporated into your PGS gas grill to provide you and your family the maximum in safety when operating the grill.

PLEASE DO NOT CHANGE THE LP HOSE OR USE WITH A TANK LARGER THAN 20 LBS. OR TO A TANK EQUIPPED WITH ANYTHING OTHER THAN A QCCI FITTING. TURN VALVE THAT IS LOCATED AT THE TOP OF TANK TO "OFF" WHEN GRILL IS NOT IN USE.

PROPANE CYLINDER FILLING & HANDLING TIPS

When the hose and regulator are disconnected from the tank, the flow of gas is safely shut off. You must still shut off the main tank valve located at the top of the tank when transporting your tank or when the unit is not in use.

- Do not modify hose or LP fittings. Contact local dealer or distributor if tank, hose or fittings need replacement.
- If it is evident there is excessive abrasion or wear, or the hose is cut, it must be replaced prior to the grill being operated. Please see your local PGS dealer or call the factory for an exact replacement.
- Store propane tank outdoors in a cool, well ventilated area. Never store extra tanks in, on, or around your grill.
- Turn off tank when not in use.
- Transport tanks upright ONLY.
- Never allow a tank to be overfilled. 100% empty tanks hold only 4.5 gallons of propane.
- Inspect your grill cabinet often to ensure that ventilation openings in sides and back of cart are free from debris and have proper air circulation.
- Never paint LP cylinder a dark color. This may cause OVERHEATING. Do not apply heat directly to tank.
- LP Gas is stored under high pressure and must be handled with care. Do not handle a tank roughly.
- Be sure your LP gas dealer checks the cylinder with a soapy solution for leaks after filling.
- Do not turn gas valve on unless connection between regulator and tank is complete.
- Storage of your gas grill indoors is permissible only if the cylinder is disconnected, removed from grill and cylinder stored outdoors in a well-ventilated area away from children.

BEFORE ATTEMPTING TO LIGHT GRILL, BE CERTAIN THE GAS VALVE KNOBS ARE IN THE OFF POSITION. TURN TANK VALVE ON BY TURNING KNOB ON TOP OF TANK, COUNTER CLOCKWISE. CHECK ALL CONNECTIONS WITH A SOLUTION OF 50% LIQUID SOAP, 50% WATER. SOLUTION CAN BE SPRAYED ON WITH A SPRAY BOTTLE OR PAINTED ON ALL CONNECTIONS WITH A BRUSH. IF BUBBLES APPEAR THERE IS A LEAK, TURN OFF GAS, TIGHTEN FITTINGS AND REPEAT THIS CHECK.

NOTE. IF PRESSURE REGULATOR AND HOSE SUPPLIED WITH GRILL IT MUST BE USED. REPLACEMENT SHOULD BE OEM EXACT REPLACEMENT ONLY.

The cylinder must be provided with a shutoff valve terminating in an LP-gas supply cylinder, valve outlet specified, as applicable, for Connection No. 510 in the Standard for Compressed Gas Cylinder Valve Outlet and Inlet Connections, ANSI/CGA-V-1, or Connection No. 600 in the Compressed Gas Association's Limited Standard Cylinder

Valve Outlet Connection for Propane Small Valve Series or a combination LP-gas cylinder valve and QCCI assembly complying with 1.5.5-c and a safety relief device making a direct connection with the vapor space of the cylinder. The cylinder supply system must be arranged for vapor withdrawal and must include a collar to protect the cylinder valve.

PROPANE GAS CYLINDER

DISCONNECTED CYLINDER MUST NOT BE STORED IN A BUILDING, GARAGE OR ANY OTHER ENCLOSED AREA. BEFORE LIGHTING GRILL, INSPECT THE HOSE TO ENSURE THAT IT IS IN TACT AND THERE ARE NO LEAKS.



All LP-gas cylinders used with this grill shall be approximately 12" in diameter and about 18" in height. The maximum fuel capacity must be 20 lbs. of propane (47.7 lbs. nominal water capacity or 4.5 gallons). DO NOT connect your grill to a propane gas cylinder that exceeds this capacity. **USE ONLY CYLINDER DESCRIBED IN THIS SECTION.**



All propane-gas cylinders used with the grill must be constructed and marked in accordance with the specifications for propane-gas cylinders of the U.S. Department of Transportation (DOT). In Canada, gas cylinders must meet CAN/CSA-B339-Cylinders, Spheres, and Tubes for Transportation of Dangerous Goods: and Commission. Cylinder used must include a collar to protect the cylinder valve.

All refillable propane-gas cylinders used with the gas grill must be inspected at every filling and must be re-qualified by licensed LP-gas cylinder filler in accordance with DOT (US) or CTC (Canadian) requirements for LP-cylinders.

LP-Gas Tank Specifications:

Weight (filled)	40 lbs	(18.14 kg)
Capacity	4.5 gallons	
Diameter (outside)	12 1/8"	(30.8 cm)
Height	18"	(45.7 cm)
Connection	TYPE I (QCC)	

NATURAL GAS MODELS

Your PGS gas grill has been designed and produced for outdoor use only! Every gas-burning appliance produces carbon monoxide and should not be allowed to accumulate in confined areas. DO NOT OPERATE YOUR PGS GAS GRILL INSIDE A HOME, GARAGE, RECREATIONAL VEHICLE, BOAT OR ANY OTHER ENCLOSED AREA.

NEVER ATTEMPT TO OPERATE YOUR NATURAL GAS GRILL USING PROPANE, CHARCOAL OR ANY OTHER FUEL SOURCE.

The grill is designed to operate on Natural Gas at a pressure of 4.5" water Column (W.C.) (1.75 kPa) unregulated. Check with your gas utility for local gas pressure. Use of your gas grill at pressures other than approximate 4.5" water column could affect the performance of your grill and requires installation of a natural gas regulator set at 4.5" W.C. When choosing a location for your grill, you must locate it at least 30" away from any combustible material and out of traffic paths. The grill and its individual shutoff valve must be disconnected from the gas supply piping system during any pressure testing of that system at test pressures in excess of 1/2 psig (3.5kPa). The grill must be isolated from the gas by closing its valves during any pressure testing of the gas supply piping system at test pressures equal to or less than 1/2 psig (3.5kPa).

SAFETY PRECAUTIONS

IF YOU SMELL GAS:

1. Shut off gas to the appliance.
2. Extinguish any open flames.
3. Open lid.
4. If odor continues, immediately call your gas supplier.

CALIFORNIA PROPOSITION 65 –WARNING The burning of gas cooking fuel generates toxic byproducts, which are on the list of substances that are known by the State of California to cause cancer or reproductive harm. California law requires businesses to warn customers of potential exposure to such substances. To minimize exposure to these substances, always operate this unit according to this manual, ensuring you provide good ventilation when cooking with gas. This warning is issued pursuant to California Health & Safety Code Sec. 25249.6

SAFETY PRACTICES TO AVOID PERSONAL INJURY

When properly cared for, your grill will give safe, reliable service for many years. However, extreme care must be used since the grill produces intense heat, which can increase accident potential. When using this appliance, basic safety practices must be followed, including the following:

Read this Manual carefully and completely before using your grill to reduce the risk of fire, burn hazard or other injury.

Begin by ensuring proper assembly. Do not repair or replace any part of the grill unless specifically recommended in this manual. All other service should be referred to a qualified technician. For personal safety, wear proper apparel. Loose fitting garments or sleeves should never be worn while using this appliance. Some synthetic fabrics are highly flammable and should not be worn while cooking. Never let clothing, pot holders or other flammable materials come in contact with or too close to any grate, burner or hot surface until it has cooled. Fabric may ignite and result in personal injury.

Do not use aluminum foil to line the grill bottom (it may be used to line Grease Tray). This can severely upset combustion airflow or trap excessive heat in the control area. The result of this can be melted knobs, igniters and increased chance of personal injury.



Children should not be left alone or unattended in an area where the grill is being used. Never allow them to sit, stand or play on or around the grill at any time. Do not store items of interest to children around or below the grill.

Do not heat unopened food containers as a build-up of pressure may cause the container to burst. Use a covered hand when opening the grill lid. Never lean over an open grill. When lighting a burner, always pay close attention to what you are doing. Be certain you are depressing the igniter button. When using the grill: do not touch the grilling grids, burner, casing or immediate surrounding area as these areas become extremely hot and could cause burns.

For proper lighting and performance of the burner, keep the ports clean. The burner will only operate in one position and must be mounted correctly for safe operation. Clean the grill with caution. Avoid steam burns; do not use a wet sponge or cloth to clean the grill while it is hot. Some cleaners produce noxious fumes or can ignite if applied to a hot surface.

INSECT WARNING. Spiders and insects can nest in the burner of this and any other grill, and cause the gas to flow from the front of the burner. This is a very dangerous condition, which can cause a fire to occur behind the valve assembly, thereby damaging the grill and making it unsafe to operate.

DO NOT OPERATE THE GRILL UNDER UNPROTECTED COMBUSTIBLE CONSTRUCTION. Use only in well ventilated areas.

Do not use in buildings, garages, sheds, breezeways or any enclosed areas. Keep the area surrounding the grill free from combustible materials, trash, or combustible fluids and vapors such as gasoline or charcoal lighter fluid. Do not obstruct the flow of combustion and ventilation air.

If the unit is stored indoors ensure that it is cool. The propane cylinder must be unhooked and stored outside in a well-ventilated area, out of reach of children. Never use the grill in windy conditions. If located in a consistently windy area (oceanfront, mountaintop, etc.) a wind-break will be required. Always adhere to the specified clearance. Position grill so that prevailing breeze is hitting side of grill, not front or back.

LOCATION

When determining a suitable location, take into account concerns such as exposure to wind, and proximity to traffic paths. Locate the grill only in a well-ventilated area. Never locate the grill in a building, garage, breezeway, shed or other such enclosed areas with out an approved ventilation system. During heavy use, the grill will produce a lot of smoke. Grill should be placed on a sturdy, level surface. In breezy conditions face side of grill towards prevailing direction. Do not face front or rear of grill in direction of breeze as wind will disrupt burners and possibly overheat knobs and ignition system.

Please note wind entering back of grill may push burner flames forward causing control knobs to get hot. If you have a prevailing breeze, place grill with side of grill facing breeze direction. If building into a masonry island, have side of island facing breeze not front or back of island.

CLEARANCE



To Non-Combustible Construction

A minimum of 6" clearance from the back of the grill to non-combustible construction is required to insure hood opens fully.

To Combustible Construction

A minimum clearance of 30" between the grill and any combustible materials is required. This includes all sides with no combustible material above as the grill and all surfaces produce heat.

ASSEMBLY INSTRUCTIONS

Below instructions are for a LEGACY grill on a Portable Cart. If you are installing in a masonry application, skip to step #12.

If your grill has an Infra-Broil Rear Burner, see page 13 for use and care instructions.

Cut bands off of outer cartons of the grill head and also the cart. With two people lift the outer carton off the pallets.

1. Carefully remove all plastic and packaging, break top half of Styrofoam form encasing grill head away from grill. Put grill head aside, **ASSEMBLE CART FIRST.**
2. Inside cart box you will find:
 - a. 4 shelf brackets labeled (2each) left and right
 - b. 2 side shelves
 - c. 2 locking wheels
 - d. 2 non locking wheels
 - e. 1 interior shelf (for 36" cart only)
 - f. Hardware bag which includes
 - Qty 16 8mm screws
 - Qty 16 8mm flat washers
 - Qty 16 8mm spring (lock) washers
3. Remove doors from cart by lifting them off pegs
4. Flip cart so it is upside down, put a flat washer and then a locking washer on each of the (16) 8mm screws.

5. Place the 2 locking casters on the same end of the cart (makes no difference which) and attach to cart by inserting screw/flat washer/lock washer in each of the four pre-attached nuts. **DO NOT TIGHTEN UNTIL ALL FOUR ARE STARTED. DO NOT CROSS THREAD.** Screws can be tightened with an Allen-wrench, vice grips on channel locks.
6. Attach the two non-locking wheels to the other side of the cart.
7. Flip cart back upright and attach two right-hand side shelf brackets to the right-hand side of the cart, and the two left-hand to the left-hand side with the angled edge at the bottom and the straight edge on the top. Attach each bracket with Philips head screws that are provided.
8. Attach side shelf kits. Note side of shelf with an opening. Other side (no opening) should be placed over peg on side shelf bracket first. With the shelf level, push opening in side shelf through other peg on opposite bracket.
9. If you purchased a 36" cart, 4 threaded pegs were provided. Choose location of cart inner shelf (high, medium or low) and screw pegs through all four corners to secure shelf. Shelf then sits upon four pegs. **DO NOT REINSTALL CART DOORS YET, SEE STEP #18.**
10. **WITH TWO PEOPLE, CAREFULLY LIFT GRILL HEAD ONTO ASSEMBLED CART. LIFT GRILL HEAD ONTO CART, PLACING ON BACK OF CART FIRST, THEN LOWER FRONT EDGE. IF PROPERLY INSTALLED, GRILL HEAD WILL BE LEVEL WITH NO GAPS BETWEEN THE CART AND THE GRILL HEAD.** Remove the transport brace and two screws holding it in place and dispose.
11. REMOVE GREASE TRAY AND **NOTE TYPE OF FUEL USED. IF WRONG TYPE OF FUEL IS MARKED, STOP ASSEMBLY AND CHECK WITH YOUR LOCAL DEALER.**
12. Unscrew ignitor cap by turning it counter clockwise. Insert a fresh AA Battery with **+ side out.** Screw ignitor cap back on being careful not to over-tighten. Push button, if properly installed should hear sparking at all ignitor electrodes. **CHANGE BATTERY EVERY SIX MONTHS!**



13. If your PGS grill is L.P., it comes standard with a 16" heavy duty steel lined hose that is shown attached (see image below for location). Be certain hose is sufficiently tightened prior to connecting to propane cylinder. **Be sure to check the connection from the LP hose to the manifold with a soapy solution if you see bubbles tighten this fitting and check again.**



LP HOSE AND REGULATOR CONNECTION TO MANIFOLD

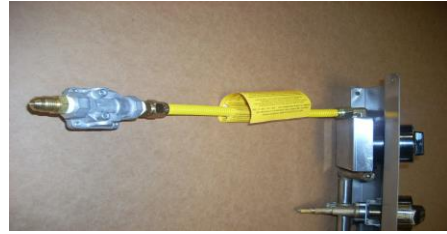

**NATURAL GAS CONNECTION TO GRILL MANIFOLD
NATURAL GAS REGULATOR ASSEMBLY INCLUDED (4.5" W.C.
1/2psig) Use with Natural Gas only, pictured above**



LP Cylinder mounted to cart retention ring and LP Hose and regulator. Note hose needs to be positioned away from bottom of grill.

NOTE: FITTINGS ARE MADE OF BRASS, A SOFT METAL. USE CAUTION WHEN CONNECTING DO NOT CROSS THREAD FITTINGS

14. If Natural Gas attach Natural Gas Regulator assembly (gas inlet connection, natural gas regulator, 3-way brass tee, optional accessory gas supply cap, and swivel connector) to the 3/8" male flare found below the knobs on the right hand side of the control panel.
15. **Tighten all gas connections.**
16. **TURN YOUR GAS SUPPLY ON AND TEST ALL FITTINGS FOR LEAKS. BEFORE ATTEMPTING TO LIGHT GRILL, BE CERTAIN ALL VALVE'S ARE IN THE OFF POSITION.**  **TURN GAS SUPPLY ON** (leaving all control knobs to the "OFF" position) **AND CHECK ALL CONNECTIONS WITH A SOLUTION OF 50% LIQUID SOAP, 50% WATER. SOLUTION CAN BE SPRAYED ON WITH A SPRAY BOTTLE OR PAINTED ON ALL CONNECTIONS WITH A BRUSH. IF BUBBLES APPEAR, TURN OFF GAS, TIGHTEN FITTINGS AND TRY AGAIN. NEVER CHECK FOR LEAKS WITH A MATCH OR FLAME.**
17. Line grease tray with aluminum foil. Change one a month.
18. If purchased a portable cart, reinstall doors on cart frame.

ORIFICE ENGAGEMENT

At the end of each valve there is a tiny gas opening known as an orifice. Gas exits the orifice and enters a venturi where it mixes with air. The proper mixture of gas and air produces a clean blue flame with slight yellow tips at the burner. **BE CERTAIN THAT ORIFICES ARE FULLY ENGAGED INTO THE BURNER VENTURI TUBES AS PICTURED BELOW. Proper orifice engagement should be 1/4" to 3/8" into the venturi's.** Failure to insure this connection may cause fire and result in serious damage to your grill.



PROPANE CYLINDER CONNECTION



L.P. cylinder is connected to grill via a hand wheel. When full, cylinder weighs nearly 42 pounds to handle with care. Place cylinder in retaining ring and tighten screw on ring to secure tank. Place LP Regulator hand wheel in LP tank outlet, tighten hand wheel.

NOTE, in not sufficiently tightened, fuel will not flow from tank to grill. TEST connection with soapy solution to insure no leak. If removing tank, reverse procedure being certain to use care.

GAS LEAK TEST

After grill is fully assembled, tighten all connections, fittings and screws. Please note that during transport, connections and screws may become loose... check all.



BEFORE ATTEMPTING TO LIGHT GRILL, BE CERTAIN THE GAS VALVE KNOBS ARE IN THE OFF POSITION. TURN GAS SUPPLY ON CHECK ALL CONNECTIONS WITH A SOLUTION OF 50% LIQUID SOAP, 50% WATER. SOLUTION CAN BE SPRAYED ON WITH A SPRAY BOTTLE OR PAINTED ON ALL CONNECTIONS WITH A BRUSH. IF BUBBLES APPEAR THERE IS A LEAK, TURN OFF GAS, TIGHTEN FITTINGS AND REPEAT THIS CHECK, NEVER CHECK FOR LEAK WITH OPEN FLAME.

PLEASE NOTE!!! ABOVE PROCEDURE IS IMPERATIVE FOR SAFE OPERATION ON YOUR GRILL.

LIGHTING YOUR GRILL

ALWAYS OPEN THE LID COMPLETELY BEFORE LIGHTING THE BURNER. This is to avoid trapping gas fumes, which could explode. Do not stand with your head over the grill when lighting the burner.

Please note: Grills equipped with Rear Infrared Burner have a control knob located to the far right of the control panel.

NEVER use Rear Burner and Bottom Burners at the same time. Be sure new AA battery is installed below black rubber cover on control panel. With any burner valve turned to high, gently depress ignition button. If ignition do not immediately occur, turn controls OFF to prevent gas build-up. Wait five minutes for gas to clear and try the above procedure again. If the burner does not light with the electronic ignition, light the burner with a match or other hand held ignitor. **DO NOT TOSS A LIT MATCH INTO THE UNIT AND TURN THE GAS ON!**

IF YOUR GRILL FAILS TO LIGHT

At the right hand side of the lower grill housing; near the top of the cooking grid, there is a match lighting port. Raise the grill lid. Light a match (or other ignitor) and turn the LOWER BURNER RIGHT hand control knob to HI. Hold the lit match (or ignitor) just above the ignition port and light the grill, you should hear the grill ignite within five seconds. IF THE GRILL STILL FAILS TO LIGHT, CHECK THE GAS SUPPLY. YOU COULD BE OUT OF LP GAS OR THE MAIN GAS SUPPLY FOR NATURAL GAS MAY HAVE BEEN TURNED OFF. The lower lighting port will not light the rear burner. This must be lit with the ignition system or a hand held ignitor.



Manual Lighting of Grill

NOTE: If grill is hot, manual lighting tube may not work. Allow grill to fully cool before relighting.

ELECTRODE ADJUSTMENT

The electrode and ground wire is fixed and checked at the factory for optimum spark. The tip from the electrode is 1/8" away from the grounding wire. Spark may get "hotter" by SLIGHTLY increasing or decreasing the distance between these two wires. Please note, you should not increase the distance between these two wires to more than 3/8". In the event that this spacing cannot be corrected or the ceramic insulator is cracked and needs replacement, the entire assembly is easily changed by removing the grease tray, remove the screw and nut holding assembly, unplugging from ignition module and reinstalling new.

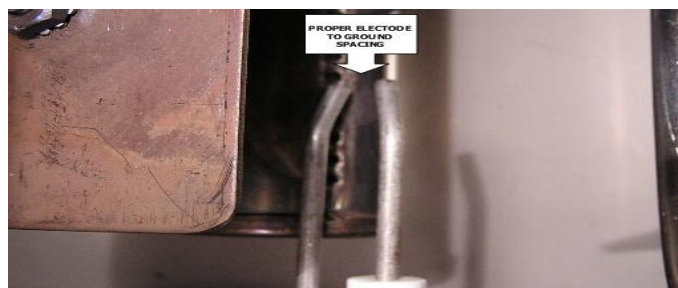

NOTE GAP ON ELECTRODE AND GROUND WIRE SHOULD BE APPROXIMATELY 1/4"

GREASE TRAY LINING & CLEAN OUT

Before using grill, we suggest you **LINE YOUR GREASE TRAY WITH HEAVY-DUTY ALUMINUM FOIL.** We also recommend periodic inspection and clean out of the grease tray provided with your PGS gas grill. You will find this very easy. The foil should be replaced at least every ten grill uses or more often if you are cooking fatty meats.

If you have left your grill out in rain without covering, grease tray may accumulate water. Please empty prior to use.

Please note that cooking especially juicy meats may require replacement of foil more often. Regular replacement will add life to grease tray. Foil should be cool to the touch before replacement.

PERIODIC CLEANING

Knowing how to remove and replace the burner allows you to easily and thoroughly clean your grill. Even though "Burning Off" the grill after every cookout will keep it ready for use, once a year you should perform basic maintenance to keep it in top operating condition.

BE SURE THAT YOUR GAS SUPPLY IS OFF AND THAT YOUR FEEDLINE IS BLED OF ANY GAS.

Remove your burner assembly by first removing cooking grids and then rock grates with rock on them, then gently pull up on the back of the burner assembly. Remove the burner/venturi assembly; cover the valve orifices with a small piece of aluminum foil to keep out dirt. Brush both sides and bottom of the inside of the burner with a stiff wire brush. Any clogged flame holes may be opened using a thin wire. Use a bottlebrush, pipe cleaner or long flexible wire to clean out the venturis. (See Flashback Section). Since the grill housing is heavy rust-free stainless steel, you are only trying to remove built up grease and debris. **DO NOT BEND OR DAMAGE THE IGNITION PROBE.**

After cleaning burner assembly and the lower housing of grill, reinstall burner. **TURN YOUR GAS SUPPLY (LP OR NAT) ON AND TEST ALL FITTINGS FOR LEAKS. BEFORE ATTEMPTING TO LIGHT GRILL, BE CERTAIN BOTH VALVES ARE IN THE OFF POSITION. TURN GAS SUPPLY ON** (leaving both control knobs to the "OFF" position). CHECK ALL CONNECTIONS WITH A SOLUTION OF 50% LIQUID SOAP, 50% WATER. SOLUTION CAN BE SPRAYED ON WITH A SPRAY BOTTLE OR PAINTED ON ALL CONNECTIONS WITH A BRUSH. IF BUBBLES APPEAR, TURN OFF GAS, TIGHTEN FITTINGS AND TRY AGAIN.

We also recommend keeping your grill covered at all times when not in use. For cleaning all stainless steel surfaces, use a good grade of stainless cleaner such as our PGS "SSC"(spray Stainless Steel Cleaner) or our SS Wipes (towelettes with cleaner on them). To maintain cooking grids, we recommend brushing with a grill cleaning brass brush after grill has completely cooled. A light vegetable oil on grids just before cooking will prevent food from sticking to the surface. **NEVER PLACE COOKING GRIDS IN A SELF-CLEANING OVEN.** If grids are very dirty, you may want to place them in a plastic bag with one cup of ammonia in it, place in sunshine for a day, thoroughly rinse and put back in grill. Be sure to oil before using.

FLARE-UPS

When you cook fatty foods over an open flame, you can expect flare-ups. Natural juices falling on the hot briquettes result in flame and smoke that give foods cooked on your grill that delicious outdoor flavor and appearance. Expect and encourage a MODERATE amount of flare-up. We suggest that you trim off excess fat before cooking. Excessive flare-ups occur when cooking extra fatty foods, or if cooking temperatures are too high. To control flare-ups:

- Turn your control knob(s) to a lower heat setting.
- Move the meat to another part of the grill, if possible. With multiple burners, you can cook on one side and move food, as necessary to the unlighted side or lower heat setting.
- Cook with the lid open to reduce heat inside of grill head. Periodically flip rock so that it can self clean.
- If you need to immediately control any excessive flare-up, spray the flame with water or throw a small amount of baking soda directly on briquettes (avoid baking soda on food).

FLASHBACK

In many areas, spiders or small insects have been found to create "flashback" problems. The spiders spin webs and/or insects build nests in the grill's venturi tube(s). The web and/or nests can lead to gas flow obstruction, which can damage your grill as it results in a "flashback" (a fire in the venturi tube(s)). See illustration below. The grill may still light, but the obstruction does not allow full gas flow to the burner.

Therefore, some gas will back up and escape at the venturi air shutter.

This will ignite, causing flashback, which could also damage your grill (see illustration). To remove spider webs and/or other obstructions, you must remove the burner and clean out the venturi with a long narrow bottlebrush.



DRAWING BELOW IS TO SHOW SPIDER WEB IN VENTURI AND IS NOT THE SAME AS PROVIDED WITH YOUR PGS GRILL

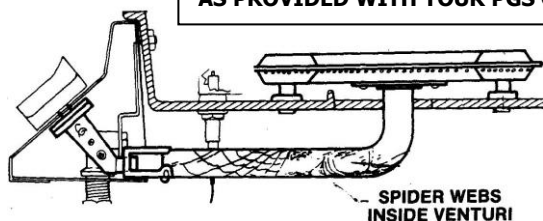

Spider webs inside venturi

THIS SHOULD BE DONE ROUTINELY AFTER THE GRILL HAS SET IDLE FOR EXTENDED PERIODS. Your PGS grill has fine mesh brass screening placed inside the burner venturis to minimize this problem. Please DO NOT damage or remove these screens when you clean your burners.

BE CERTAIN THAT YOUR GAS SUPPLY IS OFF AND YOUR GAS FEED LINE HAS BEEN BLED OF ANY FUEL. REMOVE BURNER AS DESCRIBED IN THE PERIODIC CLEANING SECTION. CLEAN OUT THE VENTURI WITH A VENTURI CLEANING BRUSH, PIPE CLEANERS, OR OTHER SIMILAR ITEM.

BE CERTAIN THAT THE BURNER VENTURI'S ARE ENGAGED ON VALVES AT LEAST 1/2".

If you live in an area where spiders are plentiful, you should make it a point to clean the venturis often. You may want to spray around the bottom of your cart or masonry enclosure with an insect repellent on a regular basis. You may also put MOTH BALLS in the bottom of your cart or masonry enclosure. PLEASE BE CERTAIN TO KEEP THEM AWAY FROM ANIMALS AND CHILDREN.



BEFORE LIGHTING YOUR GRILL:

TURN YOUR GAS SUPPLY (LP OR NAT) ON AND TEST ALL FITTINGS FOR LEAKS. BEFORE ATTEMPTING TO LIGHT GRILL, BE CERTAIN BOTH VALVES ARE IN THE OFF POSITION. TURN GAS SUPPLY ON (leaving both control knobs to the "OFF" position) **AND CHECK ALL CONNECTIONS WITH A SOLUTION OF 50% LIQUID SOAP, 50% WATER. SOLUTION CAN BE SPRAYED ON WITH A SPRAY BOTTLE OR PAINTED ON ALL CONNECTIONS WITH A BRUSH. IF BUBBLES APPEAR, TURN OFF GAS, TIGHTEN FITTINGS AND TRY AGAIN. NEVER TEST FOR LEAK WITH MATCH OR AN OPEN FLAME..**

NOTE: Replace battery when sparks noticeably slow down or every six months, whichever is first. If you are not going to use your grill for 30 days or more, remove battery.

GAS GRILL CONVERSION

We strongly recommend having your gas grill converted by a servicing dealer, your local gas utility or other trained personnel. PLEASE NOTE, IMPROPER ORIFICE SIZE COULD RESULT IN EITHER INSUFFICIENT OR EXCESS GAS GOING TO BURNER, AND MAY POSE A SAFETY RISK.

GRILL TROUBLESHOOTING

SPIDER AND INSECT WARNING

Spiders and insects can nest in the burners of this or any other grill, and cause the gas to flow from the front of the burner. This is a very dangerous condition, which can cause a fire to occur behind the valve panel, thereby damaging the grill and making it unsafe to operate.

WHEN TO LOOK FOR SPIDERS

You should inspect the burners at least twice a year or immediately if any of the following conditions occur:

1. The smell of gas in conjunction with the burner flames appearing Yellow.
2. When you light the grill, sound is significantly different than normal.
3. The Grill does not reach temperature.
4. The Grill heats unevenly.
5. The burners make popping noises.

BEFORE CALLING FOR SERVICE/TROUBLESHOOTING CHECKLIST

Grill won't light when the igniter button is depressed.

Replace Battery

Ensure electrode is attached to igniter module and also to the end of the electrode behind the burners. **DO NOT TURN THE CONTROL VALVE "ON" AT THIS STAGE.** Depress the igniter button and watch the igniter tip. You should see a spark jump from the tip of the igniter when the button is pressed. If there is no spark, clean the igniter tip and free from debris. Readjust for proper gap.

If there is a spark, is there gas supplied to the unit and is the link purged of air? Can you match light the burner? Check the orifice for blockage

Burner flame is yellow or orange, or is there the odor of gas.

Turn the burner off. Check the burner inlet for obstructions (spiders, etc). Adjust the air shutter rings to allow more or less gas found at the end of the burner venturis. Is the grill in a dusty area?

Low heat - with the control knob set to the "HI" position.

- Does the orifice or burner need cleaning?
- Is the gas supply, or gas pressure low?
- Is the grill being preheated for 10-15 minutes?
- Is there L.P. gas in the tank?

CARE OF STAINLESS STEEL

Stainless Steel is widely used for catering and residential kitchen equipment because of its strength, its ability to resist corrosion and its ease of cleaning. In fact, stainless steel ranks alongside glass and new china in terms of "ease of cleaning" and in percentage removal of bacteria during washing up. As a result of these virtues, the metal is often taken for granted and it is assumed that no problems will arise during its usage. However, some care is required to ensure that the stainless steel can live up to this reputation.

DAY-TO-DAY CARE

To maintain the original appearance of your PGS, a regular cleaning routine should be carried out using the following guidelines:

1. After use, wipe the Grill with a soft, damp, soapy cloth and rinse with clean water, preferably warm/ hot water. This should remove most substances encountered during the grilling process.



2. For more tenacious deposits, including oil, grease and water-borne deposits, PGS has a wonderful spray cleaner and also cleaning "wipes". Please see your local dealer.

3. Harsh abrasives and scouring materials should not be used for cleaning stainless steel as they will leave scratch marks in the surface and damage the appearance of the Grill. Likewise do not use wire brushes, scrapers or contaminated scouring pads.

4. Your PGS Grill has a directional polished grain, any cleaning with abrasives should be carried out along this grain and not across it

5. If required, dry the Grill after use with a soft dry cloth or towel.

If the preceding guidelines are adhered to, your PGS Stainless Steel Grill should offer excellent life and should live up to its reputation of being "stainless". Neglect of this practice, however, can lead to deterioration of the surface and, in some extreme cases, corrosion of the steel itself. The two most common types of corrosion that may be encountered, particularly on stainless steel, are rust marks and pitting of the surface.

RUST MARKS

When this type of staining occurs it is unlikely that rusting of the stainless steel itself causes the marks. Similar marks can be found with both porcelain and plastic sinks. The rust marks are more likely to be the result of small particles of "ordinary" steel which have become attached to the surface; these have subsequently rusted in the damp

environment. The most common source of such particles is from "wire-wool" scouring pads, but contamination may also occur from carbon steel utensils and cast iron water supply pipes. These brown marks are only superficial stains, which will not harm the Grill; they should be removable using a soft damp cloth and a quality stainless cleaner. Occasionally, it may be necessary to resort to a proprietary stainless steel cleanser, to return the surface of the Grill to its original condition. To avoid re-occurrence of any "rust-staining" it is essential that the source of the contamination be eliminated.

PITTING

Another form of corrosion, which occasionally occurs in stainless steel, is pitting of the surface. The reason for this corrosive attack can usually be attributed to certain household products. For example:

Bleaches: Most common domestic bleaches & sterilizing solutions contain chlorine in the form of sodium hypochlorite. If used in concentrated form, bleaches can attack the stainless steel, causing pitting of the surface. They should always be used to the strengths prescribed by the manufacturer and should be thoroughly rinsed off with clean water immediately after use.

Foodstuffs: In general stainless steel is fully resistant to all foodstuffs in common use. Only in isolated cases, such as when concentrated salt and vinegar mixtures are allowed to remain in contact with the steel for a long period, can any surface marking result.

COOKING GRIDS

Routine cleaning of the grill grids is best accomplished by scrubbing the grids with a brass or stainless steel brush immediately before and after cooking, while the grill is hot. Wear a barbecue mitt to protect your hand from the heat while cleaning. When needed, remove the grids from the grill and scrub with a soap solution or oven cleaner. Rinse thoroughly, and allow the grids to dry completely before reinstalling onto grill.

MASONRY ENCLOSED GRILL

PGS grills are easily installed in Masonry enclosures. No additional supports "frames" are necessary. We have included a natural gas regulator set at 4.5" w.c. which must be installed for proper grill performance when grill is fuel by Natural Gas. Please have masonry contractor examine grill before building enclosure to ensure proper clearance for the natural gas regulator and gas connection from building material. A "carve out" of the masonry material may be necessary to accommodate regulator combination shown on page 9.

ENCLOSURE MUST BE CONSTRUCTED OF A NON-COMBUSTIBLE MATERIAL AND MUST BE AT LEAST 30" AWAY FROM ANY COMBUSTIBLE MATERIAL WITH NOTHING COMBUSTIBLE ABOVE. ADDITIONALLY, ISLAND MUST BE VENTED TO INSURE PROPER AIR FOR COMBUSTION AND FOR DISBURSION OF GAS IN THE EVENT OF A GAS LEAK. PLEASE CHECK LOCAL BUILDING CODES TO INSURE ISLAND HAS ADEQUATE VENTILATION.

Masonry Cutouts

Model	Height	Depth	Width
Newport (S27, S27T)	9 1/2"	23"	28"
Newport Gourmet	9 1/2"	23"	28"
Pacifica (S36, S36T)	9 1/2"	23"	36 1/2"
Pacifica Gourmet	9 1/2"	23"	36 1/2"
BIG SUR	9 1/2"	23"	49"
MDS L30	19-3/8"		29-1/4"
MDS L36	19-3/8"		38"

Size, shape and configuration of island is up to owner. Generally island should be at least twice the width of the grill, generally accepted finished counter height is 36". Island must be constructed 100% in non-combustible materials with nothing combustible within 30" and nothing combustible above.

Please check our website: www.aeicorporation.com for more ideas. If installing LP grill in masonry island, we recommend Propane Cylinder be securely mounted OUTSIDE island with rigid, secured pipe and connections. Connectors must comply with ANZI Z21.75/CSA 6.27 and must be suitable for outside installations. Maximum length on the connections shall be 6'. Maximum pressure when using propane to fuel grill is 11.0"w.c..

INFRA-BROIL REAR BURNER

The PGS Infra-Broil Kit comes as a standard feature on our models Newport Gourmet, Pacifica Gourmet and BIG SUR. The Infra-Broil is a rear burner especially designed for those back yard chefs who love to rotisserie. It features 14,000 BTU of radiant heat for extremely efficient roistering. It will cook poultry and beef quickly and efficiently to perfection every time!



Please note, when using the Infra-Broil Burner, you should never have any of the lower burners on. Using any other lower burner at the same time as a rear burner poses potential problem with insufficient oxygen, which could cause rear burner to go out and cause a gas leak and possible explosion.

To operate, turn far right hand knob with the word "ROTIS" under it to the "HI" position. Push Sure Start Ignition button. Burner should light within five seconds. IF THE BURNER FAILS TO LIGHT, IMMEDIATELY TURN CONTROL OFF TO PREVENT GAS BUILD-UP. WAIT FIVE MINUTES FOR GAS TO CLEAR AND TRY THE ABOVE PROCEDURE AGAIN. IF THE BURNER DOES NOT LIGHT WITH THE ELECTRONIC IGNITION, LIGHT THE BURNER WITH A MATCH OR OTHER HAND HELD IGNITOR. TOUCH LIGHTED MATCH OR HAND HELD IGNITOR TO THE LOWER RIGHT HAND SIDE OF THE "INFRA-BROIL".

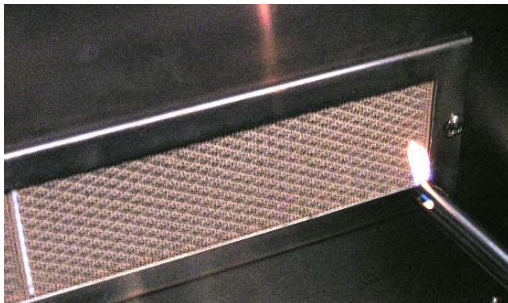

Manual Lighting of Infra-Broil Rear Burner

Rotisserie motor mount should be installed on the left hand side of the Hood Support Brackets. **Please use care when operating electric rotisserie motor and be certain that outlet used is grounded and incorporates a Ground Fault Interrupter. When operating, be sure to keep cord away from all liquids and hot surfaces.**

When using Infra-Broil back burner, we suggest that you remove the cooking grid and place a metal pan directly on the rock. We suggest that you fill pan a minimum of one quarter full with liquid and that you regularly check pan to ensure liquid remains during the entire rotisserie cooking. A counter balance is included with your PGS rotisserie kit, we suggest positioning it so that it is opposite of your meat, to balance the load on your motor.

FLAME ADJUSTMENT

Your PGS burner has been designed to operate efficiently under widely varying operating conditions and is adjusted at the factory for proper operation so no adjustments should be required. Occasionally, vibration during transport or variations in local fuels and gas pressure, altitude, or other external conditions might require minor burner adjustments. Sometimes your burner will burn differently if your propane cylinder has been recently filled or it is near empty. Sometimes air will need to be purged from your natural gas line.

A qualified technician should make burner adjustments at the time of installation. Extreme care should be exercised if adjustments are required after installation. If you need to inspect and adjust burners while unit is operating:

Carefully remove rock grates, cooking grids, and rock from bottom casting. Burner adjustments can be best performed in low light and in **non-windy conditions** so you can properly view burner operation and make proper flame adjustments. Turn gas supply on and light grill as usual.

Inspect the burner when it is on low. Flames should be mostly blue and stable. The flame tips will be yellow at the ends and this is normal. When you re-install the rock grates the burner flames impinging on the rock grates will also cause the flame pattern to appear more yellow, this is normal and does not in any way affect the performance of your grill. A burner in an outdoor appliance operates in a different environment than an indoor appliance burner or flame and as a result will visually look different.

If you see the flames lifting from the burner, or only parts of the burner are burning, or if you hear excessive noise from the burner, please check the following: valve/orifice engagement in the venturis, that the burner is level in the casting, and also check burner tubes to be certain they are not obstructed with debris or spider webs. These conditions will more often be the case than the burner being out of adjustment. If you feel that you do need to adjust the burners please follow directions below when burners are cool to the touch:

1. At the end of each of the burner venturis you will see an air mixer secured by a small setscrew. When the screw is loosened the air shutter can be rotated to allow more or less air.
2. If the flame is extremely yellow this indicates the burner is getting insufficient air. Turn the air mixer to the open position to allow more air to the burner. Tighten screw to insure mixer stays in this position.
3. If the flame is noisy and tends to lift away from the burner tube there is too much air being fed to the burner. Turn the air mixer to reduce the opening and air volume to the burner. Tighten screw to insure air mixture does not move.

4. Reinstall burner and light as normal and inspect flame. If burner requires additional adjustment repeat above procedure. There is not a significant degree of adjustment required to these burners.

Differences in altitude, operating conditions, weather conditions; gas pressures, odorants and stabilizers used in both natural gas and propane will often cause burners to burn differently. As long as you are getting good ignition, even cooking performance and the burner flame is blue with yellow tips and operating consistently, you should not have to adjust the burners.

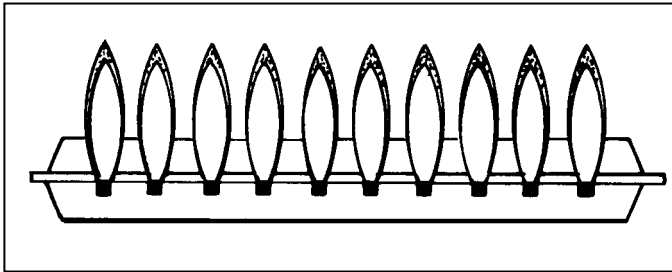

YELLOW TIPPING
Properly adjusted burner

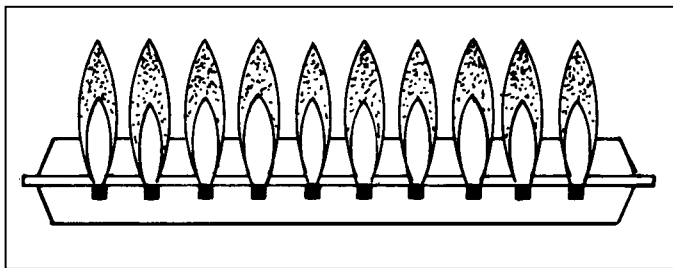

NORMAL HARD FLAMES
Slightly out of adjustment burner

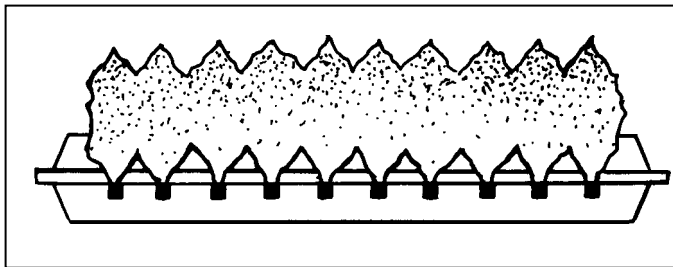

YELLOW FLAMES
Extremely out of adjustment burner

GRILL COVER

WE STRONGLY RECOMMEND COVERING YOUR PGS GAS GRILL WHEN NOT IN USE. YOU MAY PURCHASE A COVER DESIGNED TO FIT YOUR GRILL FROM YOUR PGS DEALER. ASK ABOUT OUR COVER THAT MAY BE PLACED ON YOUR GRILL JUST ONE MINUTE AFTER TURNING GRILL OFF... WHILE IT IS STILL WARM... A PGS EXCLUSIVE!

REPLACEMENT PARTS

USE ONLY PGS ORIGINAL REPLACEMENT PARTS AVAILABLE THROUGH YOUR DEALER OR CONTACT AEI CORPORATION FOR CLOSEST PARTS SUPPLIER.

BURNER, AND MAY POSE A SAFETY RISK.

TIMER TROUBLESHOOTING

PGS uses the finest mechanical timer available to control the gas flow to grill head. Operating instructions are found on the following page and if followed should provide safe and long lasting use of timer.

The timer knob should turn freely, if it impinges on the control panel it will stop and will not operate.

We recommend pulling timer knob off at least once a month and cleaning assembly with compressed air to remove any and all debris.

It is possible to break the knob if turned in the wrong direction. Replacement knobs are available from AEI Corporation.

If timer fails to operate, we offer replacement timer with knob which will require entire control panel, manifold, valve and timer assembly to be removed and taken apart.

We also offer a replacement control panel, manifold, valve and timer assembly.

PART NUMBERS FOR REPLACEMENT PARTS ARE FOUND BELOW:

PART #:	DESCRIPTION:
WA KNOB 15	TIMER KNOB (ALL MODELS)
WA 312	REPLACEMENT TIMER WITH KNOB
MTA27N	T27NG CONTROL PANEL/MANIFOLD/VALVE/TIMER
ASSB	
MTA27L	T27LP CONTROL PANEL/MANIFOLD/VALVE/TIMER
ASSB	
MTA36N	T36NG CONTROL PANEL/MANIFOLD/VALVE/TIMER
ASSB	
MTA36L	T36LP CONTROL PANEL/MANIFOLD/VALVE/TIMER
ASSB	

T Series Grills

PGS offers LEGACY series grills with a **built-in ONE HOUR FLOW timer** that will automatically shut the gas flow supply off at a maximum of one hour. The **TIMER** grills (T Series) were specifically designed for added safety, convenience and energy saving for home owners and commercial users alike.



Two models are available with the timer in the LEGACY series: S27T and S36T available in Natural Gas or Propane Fuels. To operate a grill with a built in timer, follow the instructions below:

1. **Open grill hood and turn all control knobs to the "OFF" position.**
2. **Turn Black Knob on Green Gas Flow Timer CLOCKWISE past the desired time and then back to the desired cooking time position.**
3. **Turn any control knob to the "HIGH" setting and depress ignitor button to light desired burner.**
4. **If grill fails to light within five seconds, turn control valve (s) to the off position and allow gas to clear for 5 minutes, follow above procedure again.**
5. **If grill still fails to light, see MANUAL LIGHTING section on page 10.**
6. **If grill still fails to light, see TROUBLE SHOOTING SECTION found on page 12.**
7. **When done grilling, turn all control knobs to the "OFF" position and allow timer to run out.**
8. **NEVER TURN KNOB GAS FLOW CONTROL KNOB COUNTER CLOCKWISE.**



Shown: S27T and MDS L30 Doors in Masonry Surround



The S27T and S36T come equipped with control knobs with set screws that are theft resistant with the use of an Allen screw to secure.



Shown: S36T on S36 Cart

PACIFIC GAS SPECIALTIES COOKING TIPS AND TEMPERATURE GUIDE

Cooking outdoors has truly come of age in America. What was once a frustrating experience, pitting the weekend chef against a raging charcoal inferno has evolved into an enjoyable culinary experience. Outdoor cooking has no equal in terms of flexibility, flavor, creativity or exciting presentations. "Cooking with gas" makes your outdoor cooking easier and more fun than ever! Unlike cooking with charcoal, YOU control the process rather than the process controlling YOU. Your PGS Legacy Gas grill has modern, safe, and convenient continuous spark ignition for safe lighting. Our "Performance Grilling System" has been designed to give you excellent cooking results with a minimum of hassle. You can cook outdoors year 'round!

Clean-up is a snap with your grill. No charcoal mess, ashes, or bothersome clean-up procedures! Since you'll be cooking outdoors, you will save energy by keeping the heat outdoors. After only a short time you will be able to cook all parts of your meal outdoors on the grill.

SOME BASICS

What makes outdoor barbecuing truly unique is the cook! Your PGS grill will provide you with control and flexibility beyond your expectations. There are a few basics that will help you maximize the design features of your grill. The truly masterful outdoor chef is one that masters the art of heat control. The outdoor temperature, wind conditions, gas pressure, location, and other factors all play a part in the outdoor cooking experience. On cold, windy days the heat setting specified in been designed to heat quickly using minimal amounts of fuel. Cooking on HI with the lid closed is not recommended unless you want to cook very quickly for only a short time. With the lid closed, cooking temperatures will exceed 700 degrees F... that's HOT!

The "MEDIUM " Setting

The medium setting between "HI" and "LO" can be used for most meals including steaks, chops, burgers, fish, etc. The medium setting may also be used to sear foods that have been cooked initially on the "LO" setting. Cooking with the lid open or closed is a matter of personal preference and will often be dictated by wind conditions on your patio. Cooking with the lid closed will create internal casting cooking temperatures of approximately 550 to 600 degrees Fahrenheit. Experiment with cooking with the lid open or closed and you'll quickly choose a preference. Half the fun of outdoor cooking is the experimentation. The other half will be the great cooking results you will get time and time again!

The "LO" Setting

Your PGS has an "infinite" heat control which allows you to control the heat output on one or both burners on "HI", "LO" or medium or anywhere in between. The "LO" setting is the preferred setting for most foods. Even thicker cuts of steak which have been seared on both sides on the "HI" setting will cook with a better texture and retain the juices better when cooked on the "LO" setting.

Operating the grill with both burners on the "LO" setting will create a temperature between 350 to 400 degrees F. This is perfect for roasting, baking, and rotissing. Depending on the draft or wind conditions,

our recipes might be a bit low. Just turn your heat controls to a slightly higher setting to compensate. The opposite will hold true in warmer climates or on windless days. Your own personal tastes in terms of "doneness" will also allow you to make adjustments in the cooking process.

HOW ABOUT THE FUEL SOURCE?

Your PGS outdoor gas grill operates equally well on either propane or natural gas fuel sources. If you have any questions about your fuel source please call your local LP or natural gas utility company BEFORE operating your appliance. Our assembly instructions also discuss the differences between the two gases. Both sources of fuel are environmentally positive, safe, convenient, clean burning, and efficient.

ADJUSTING THE FLAME

Every PGS grill is factory set and pre-checked to operate efficiently at sea level. If you live in a high altitude area you might have to adjust your grill slightly. Perhaps the most frustrating experience is to over cook your meat, poultry, fish, or vegetables because of excess heat. Only experience and getting to learn to use your grill will eliminate this from happening. Let's discuss the various heat settings.

The "HI" Setting

Pre-heat the ceramic briquettes and cooking grids in your grill. This setting may also be used for quick searing of meats. The "HI" setting should also be used for about ten minutes after using the grill to self-clean the cooking grids and ceramic briquettes. Your PGS grill has propping the lid up slightly will change the heat level slightly for even greater control. Again, the only limit to the flexibility of your grill is your imagination.

HOW ABOUT FLARE-UPS?

Some flare-up should not only be expected but is desirable in most outdoor cooking. The key is to control the level of the flare-up. Your PGS Grill has been designed to allow you to control the level of the flare-ups. The stainless steel grids that hold the rock and the ceramic rocks themselves have been designed to give you unequalled even cooking and flare-up control.

These two materials will become super-heated and when the fats and juices drop on the rocks and grates the majority will be vaporized and create that "outdoor" taste. When you notice the flare-up becoming excessive turn the heat setting to the low position. If the flare-up persists a hand held water sprayer may be used to dampen excessive flare-up. The lower casting of your PGS grill has been specially designed to channel excessive fats and juices out of the bottom casting and into the grease collection tray. Please be sure to check the grease tray on occasion and clean when required. If you find that you are getting too much flare-up it is generally the result of cooking with the grill too hot... the solution is to reduce the heat output.

When rotissing you may want to put an aluminum tray or drip pan under the cut of meat to capture the excessive fats and juices to further reduce flare-up. Again, flare-up is desirable when it is under your control.

HEAT OUTPUT VARIATIONS

No two gas grills will perform exactly the same way. The fuel source, line pressure or volume, method of installation, wind and weather conditions all contribute to influencing heat output and control. Irrespective of the cooking appliance cooking will always be more art than pure science.

Even slight breezes across the cooking grids will cause a temperature variation of 25 to 50 degrees. Your unit should be positioned so the wind is at the side of the grill-cooking surface. The top casting will help shield the unit from the wind. Even though your PGS grill has been designed to cook extremely evenly you might experience slight variations in heat at the cooking grids. Your variably spaced cooking grids will give you increased flexibility in this area. You should cook smaller more delicate foods like shrimp, fish, vegetables etc. on either side of your grill over the grids that have been spaced closer together. These grids allow less flare-up and will prevent smaller items from falling through the grids without the use of additional add-on accessory grates or griddles. Experiment with these areas, we're sure you'll like the results! Experiment with these areas, we're certain that you will like the results! Your grill is designed to cook hotter near the rear of the surface, thus maintaining "COOL TO THE TOUCH" control knobs. You'll soon get used to this feature and enjoy the flexibility it provides when cooking meats and vegetables of different sizes and thickness.

COOKING DIRECTLY

Cooking directly on the cooking grids is by far the most frequently used outdoor cooking method. This method is ideal for chicken, fish, burgers, shish-ka-bobs, and the list goes on and on. Meats get that great outdoor taste when the meat's natural juices drip down on the hot ceramic briquettes, caramelize, and impart that great outdoor taste. As we discussed earlier, flare-up is to be expected and is actually desirable. If you get a bit too much during the cooking process, rearrange the foods and just turn down the heat.

When the hood is closed your grill will cook faster, remain at a more controlled temperature, and use less energy. A great way to determine doneness, especially on thicker cuts of meat or poultry, is to use a meat thermometer with a probe. You can also use accessory items such as grill baskets, shish-ka-bob skewers, woks, griddles, skillet, casserole and baking dishes directly on your cooking grids. Get creative, experiment, and have lots of fun!

COOKING WITH A ROTISSERIE

One of the most flexible accessory items for your grill is the motor-driven rotisserie. Use the rotis to thoroughly cook larger cuts of meat and whole poultry. A turkey cooked to golden perfection on the grill is a real treat. You can keep the lid closed when using your rotisserie. As the rotis slowly turns, the meat will self-baste in its' own juices or you can add your own favorite sauce or marinade. The rotis will give you moist and flavorful results with just a little practice. Just remove your cooking grid or grids to accommodate the cut of meat. Insert a shallow drip pan directly on the lava rock to catch the juices and drippings. You can use these in a gravy or sauce later if desired. A meat thermometer with a probe will give you an exact indication of proper cooking times and temperatures.

INDIRECT COOKING

You can bake or roast foods in your PGS grill just like you would in a conventional oven. Casseroles, whole poultry, breads, and cakes can be cooked using this indirect method. As the name implies, the food is not cooked directly over the heat source. Instead it cooks by heated air circulating inside the grill casting. Just fire the grill on one burner and put the food on the opposite grid.

Place an oven thermometer on the unlit side of the grill while cooking indirectly. Regulate the temperature control to the desired cooking temperature. Your grill is an ideal alternate cooking source during the busy Holiday Season. Always keep the lid closed when cooking via the indirect method.

Use the following chart as a basic guide to cooking indirectly with the lid closed. If you are grilling on a very hot or cold day you will have to adjust the temperature setting up or down as required.

TEMP. GUIDE (INDIRECT COOKING)

GRILL	CONTROL	
TEMP.	SETTING	ITEM
275-350	LO	Smokes Foods, rolls, leftovers
350-425	MED	Roasts, Ribs, Fish, Poultry, Meat Loaf, Cakes Pies, Cookies, Casseroles
425-450	HI	Biscuits, Pizza, Rolls

THE MICROWAVE GRILL COMBO

Your PGS Gas Grill and indoor microwave are a great combination. Many meals that require long cooking times or defrost times may be started in the microwave and finished up on the grill. The convenience of the microwave and great taste of the outdoor grill are an unbeatable combination for those with busy schedules. Using the microwave to defrost means that you can literally go from the freezer to the grill in a matter of minutes.

Poultry, ribs, and other foods that normally take between 45 minutes and one hour to grill may be cooked by microwave for ten minutes (or to your taste) and then finished on the grill. The opposite method may also be used. Foods may be partially cooked on the grill and then frozen to be thoroughly cooked in the microwave at a later date. When you rotis a chicken do two instead and freeze one for a later meal... this will be a real hit!

Large amounts of food for a large party may be pre-cooked in the microwave then quickly seared on the grill. Get creative with these two outstanding cooking appliances to get more enjoyment and flexibility out of each appliance.

THE CALORIE/CHOLESTEROL PICTURE

It is beyond the scope of this guide to be an authority on the latest in calorie counting or cholesterol reduction. However, there are some basics that should be remembered. Outdoor cooking can be done with no added cooking oils or fats. Marinades and sauces may be made oil-free and salt free and still do an excellent job of flavoring meats, poultry, and seafood. Salt or sugar substitutes can also be used. Keep in mind that sugar substitutes will add flavor but will not glaze. Any calories contained in wine or alcohol cooks away and evaporates leaving only natural flavors.

You can save on the calories by carefully selecting the cuts of meat that you cook on your grill. Cuts should be as fat free as possible and carefully trimmed if calorie counting and cholesterol reduction are objectives. Skinless chicken breasts are low in calories, as is most seafood... both taste GREAT cooked on the grill. A little bit of pre-planning along with taking full advantage of natural flavoring possibilities will allow the dieter to join right in with the rest of the gang at barbecue time.

COOKING WITH WOOD SMOKE

Hickory, apple wood, almond, pecan, and other aromatic woods will also allow you to add the added cooking dimension of smoking on your outdoor gas grill. There are an endless amount of products available to help turn your outdoor gas grill into a very controlled smoker. You can use wood chips wrapped in foil or other containers in your grill. Just follow the directions provided with these products. Your PGS grill has been designed to accommodate these products. Our extra large casting and large rear vent allows the smoking products to totally permeate the foods you are cooking. Special marinades and sauces are the beginning of your great outdoor cooking experience. These recipes are only a guide and can be modified endlessly to appeal to your own individual tastes and cooking methods... remember, there's no right or wrong way to use your new grill!

Give these recipes a try, they are tested, tried and proven. After using them a few times feel free to get creative and add your own favorite ingredients to give these sauces your own "signature." Many of these recipes can be used to baste as well as serve as table sauces.

Wines and other spirits used in marinades add to flavor as well as tenderize. All of the alcohol evaporates during the cooking process making these acceptable for the entire family. Sauces and marinades are designed to enhance and compliment the flavor of what you are cooking and not intended to camouflage or suppress the natural taste.

Most sauces should be applied during the last 10 minutes of the cooking process and applied on the low heat settings to prevent burning. Keep a watchful eye the first time using a recipe to eliminate any "surprises" such as excessive flare-ups.

Bon Appetit!

MEATS AND MAIN DISHES

When planning your outdoor meal, the main dish should be the starting point of the menu. After deciding on the main dish you can get quite creative planning your meal around it. The design of your PGS grill allows you a great deal of flexibility in the choice and preparation of the main dish. The following section will provide you with recipes and tips that will make the most of the convenience, control, and flexibility of your PGS grill. Bear in mind, there's no single right way or wrong way to use your grill... have fun, get creative, and experiment. The more you use your PGS grill the more creative you'll become!

BEEF

Grilled hamburgers and steaks are perennial outdoor cooking favorites for the entire family. The robust outdoor flavor imparted to beef makes it easy to see why. Even though beef is relatively easy to prepare don't limit yourself to just basic burgers and steaks. Even relatively inexpensive cuts of meat tenderized with sauces and marinades will turn out great on your PGS grill. Chuck roast, brisket, and short ribs are just a few of the many beef cuts that can be grilled with delicious results.

Cooking times for the beef recipes to follow are for MEDIUM doneness. If you prefer your beef rare or well done adjust the heat and cooking times accordingly.

Do not cut or pierce the beef to check for doneness. Instead use the touch test. Lightly press your finger on the steak or burger (be careful not to burn your finger). If the meat is too hot to touch, press the back of a spoon on the meat. Use this simple test for juicy, flavorful steaks and burgers.

CHOOSING THE MEAT

The best insurance policy for a successful outdoor meal is to start with the best possible cut of meat. We suggest using only USDA Prime or Choice grade of beef. An equally important consideration is fat. A little fat "marbling" through steaks is necessary for tenderness and juice. On the other hand, too much fat can cause problems. If possible, trim off excessive fats for health reasons as well as to reduce unnecessary flare-ups that might occur. Sauces and marinades will tenderize, flavor, and garnish your beef dishes. Your individual tastes coupled with experimentation will help create countless favorites.

With the exception of steaks and pork chops, SLOW cooking will generally ensure tender meats. Use MEDIUM heat for grilled foods, including hamburgers and franks. Use LO heat for all roasts and rotisserie recipes.

FROZEN MEATS

Large roasts and thick steaks should be thawed out and brought to room temperatures before grilling. Thin steaks, franks, cold cuts, and burgers can be grilled from a frozen state. Cooking times will also be a bit longer. Frozen steaks may be thawed in a marinade or oil to retain juices and impart flavor. Do NOT salt steaks before cooking, as it tends to draw out the juices.

GREAT STEAKS

Rub or brush your steaks with oil or an oil-based marinade. This will allow you to seal the surface of the steak and will retain the juices. Preheat your PGS grill for 7 to 10 minutes on HI heat. Arrange the steaks two inches apart on the grill. Sear the steaks QUICKLY on HI or MEDIUM heat and then finish them on LO for best results. If you experience excessive flare-up from the fats and juices reduce the heat to LO immediately.

When you believe the beef is finished you can use the touch test described earlier in this section. Four 1 1/2 inch steaks should take approximately 22-28 minutes cooked on MEDIUM and then LO. Again, cooking results will vary according to the individual grill, location, weather conditions, gas pressure, and other factors.

We suggest that you tend to what you are cooking to prevent any surprises in terms of excessive flare-up or over-cooking your meal. Rearrange the steaks several times during cooking to prevent possible excessive flare-ups. Turn the steaks only once with tongs or a spatula, never pierce with a fork or you will lose the juices. The Performance Grilling System incorporated in your PGS grill was especially designed to give you great cooking results for beef meals.

The more you use your grill the better you'll control the results. Here's what to expect when you use the "TOUCH TEST".

RARE: Meat gives easily when touched. It is seared, but no juices appear on the surface.

MEDIUM: Meat feels firmer yet slightly spongy, and juices begin to appear on the surface.

WELL DONE: Meat is covered with juices. It is firm and does NOT yield to pressure.

We suggest serving your steaks immediately after grilling. Steaks will lose their juices if allowed to sit too long after cooking. A little seasoned butter (see recipe) placed on top of the steaks as soon as cooked will add a gourmet touch to your meal.

Your PGS cooking grids are specifically designed to retain the heat and cook your steaks quickly, thoroughly, and evenly throughout. Unlike conventional grids that transfer their heat to the cut of meat put on the grills and then take time to recover. Your PGS grills have the ability to retain and transfer large amounts of heat and do not require any time to get back up to proper cooking temperatures.

This may cause your cooking times to be shorter than what you may have experienced on your last outdoor cooking product. Again, keep an eye on what you are doing to prevent ruining a good cut of meat.

To achieve the "cross-char" markings used by restaurant chefs give the steak a quarter turn halfway through the cooking on both sides to sear in grill marks that cross.

ROASTS ON THE GRILL

To ensure the best possible results when cooking roasts we suggest the use of an optional PGS rotisserie and meat thermometer with probe.

Mount the roast as evenly as possible on the spit rod before cooking to minimize strain on the motor and to insure even turning. Limit rotisserie roasts to twelve pounds to avoid straining the motor and possible contact with the briquettes. Be sure that all rotisserie-cooked meats are secured to the spit rod and the thumbscrews on the meat forks are tightened securely before cooking.

Use oil or a marinade on roasts to help seal the meat surfaces and hold in the juices. Use a foil drip pan when cooking meats with a heavy fat content. Initially, you can sear the roast on HI or MEDIUM heat, but extended cooking should be at the LO setting. Keep an eye on the meat thermometer to ensure best cooking results. Cooking with the lid closed will always accelerate the cooking process. Cooking with the lid open or closed is one of personal preference. Cooking with the lid open will minimize flare-up of fatty cuts of meat. After using your grill a few times, you'll choose the method that you will be most comfortable with... grilling is an individual cooking experience!

Brush on tomato based sauces and glazes only during the final cooking period to avoid surface charring. Oil, wine, and broth based cooking sauces and marinades may be applied throughout the cooking process. Allow your roast to "set-up" for at least 10 minutes after rotissing to keep juices from being lost during carving.

* The above guide will aid you in achieving excellent cooking results. The more you use your grill the better you and the results will become. Keep in mind that several factors such as outdoor temperature conditions, wind, humidity, altitude, and size, quality, and thickness of the meat being grilled can affect your grill's cooking characteristics. Your PGS outdoor gas grill is a fun and exciting product that welcomes your involvement and creativity. Only your imagination will limit what your grill can cook!

POULTRY ON THE GRILL

Poultry and your PGS gas grill are a natural and flavorful combination. Virtually all poultry is tender and requires a minimum of cooking. Get creative with different cooking methods using your favorite sauces and marinades. Always trim away excess fat and keep an eye on the meal you are grilling to minimize unwanted flare-up. As a general rule, brush all poultry with cooking oil to seal in the flavor and juices and cook on the LO heat setting AFTER pre-heating.

Unlike other cuts of meat, chicken and poultry can be barbecued ahead of time and kept warm or re-heated prior to a later serving. This flexibility makes poultry an excellent choice for large gatherings. Poultry is popular any way you grill it. It is also economical, has tremendous versatility, and nutritious. The following recipes should be used as a basic guide. As soon as you get comfortable and familiar with the cooking ability of your PGS grill get creative.

CHICKEN ON THE ROTIS

1 (2 1/2 TO 3 1/2 Pound Whole Chicken) Paprika
Salt and Pepper Olive Oil

Remove one or both cooking grids depending on chicken size. Wash the whole chicken and pat dry with a paper towel. Sprinkle the cavity with salt and pepper. Put one rotis fork on spit and tighten securely. Run rotis rod through the chicken parallel to backbone, from a point inside the neck to just inside the tail and legs. For best results, tie the wings and legs. Secure with second fork and tighten thumbscrew securely so that it will not loosen during cooking process. Turn on Rotis motor and be sure that the chicken is balanced properly on the spit rod to minimize

any strain on the rotis motor. Balancing the cut of meats that you are rotissing will increase the life of the motor. Brush the outside of the chicken with olive oil and sprinkle salt, pepper, and paprika. You can also try your favorite seasoning salt. Cook at the low heat setting for 40 to 50 minutes. For consistent results use a meat probe thermometer for accuracy and degree of doneness. Insert a drip pan halfway through the cooking process and baste with your favorite BARBECUE or cooking sauce.

FISH & SEAFOOD

Your PGS grill has been designed with particular attention to the special requirements needed to cook fish and seafood easily. Our performance grilling system has been designed to provide you with even cooking temperatures as well as the added flexibility of our variably spaced grids for small more delicate seafood items. Your grill will greatly enhance the mild taste of most seafood and fish. Outdoor cooking enthusiasts have always considered fish and seafood the most challenging, yet most

rewarding, outdoor cooking endeavors. Adding sauces and marinades to fish and seafood will truly make the little extra effort required worthwhile. Just keep a few basic points in mind.

Small whole fish, fillets, steaks, and seafood kabobs, are best when cooked quickly or prepared in a Rotis basket. Wrapping seafood, both large and small, in foil insures against breakage. Very small and delicate pieces of seafood can be cooked on the "Vari-Grids" or on a sheet of aluminum foil for easy handling. Fish is generally considered "oily" or "non-oily." You can generally tell the difference by feeling the meat. Oily fish should be grilled with a minimum of basting. Non-oily fish has a tendency to dry out. Using a basting sauce that contains oil plus seasonings can minimize this, and wine or lemon juice as required adding moisture. Experiment a bit and you'll develop methods that will produce the desired results. Your grill is a wonderful way to cook fish and seafood! Freshness is the consistent key to great outdoor seafood meals. You should always thoroughly defrost seafood prior to grilling.

BEEF COOKING GUIDE

(Grill Preheated 5-15 Minutes)

<u>Item</u>	<u>Amount of Meat</u>	<u>Heat Setting</u>	<u>Cooking Time for Medium Doneness</u>	<u>Cooking Tips and Methods</u>
Hamburgers	1/2 lb.	Medium	8-10 minutes	Grill with hood closed, turn once
T-bone or Porterhouse Steaks	1 to 1.5 lb.	Medium	8- 10 minutes	Trim off excess fat, cook with hood closed minimize flare up, turn steaks once
Sirloin Steaks	1 1/2 " thick	Medium	15-18 minutes	Same as above, sear meat quickly on HI then reduce heat
Top Round	1 1/2 " thick	Medium	18-22 minutes	Marinate first, cook with lid closed turn only once.
Flank	3/4 " thick	High	10-13 minutes	Marinate or tenderize, score with diamond pattern, cook with lid closed, turn once.
Pot of Chuck Roast	3 lb. 1.5" thick	Medium	55-75 minutes feeds 6 to 8	Marinate or tenderize first, sear outside quickly, turning once. Place in a grill safe baking dish with 1 can of onion soup and one can of water. Grill using indirect cooking method by turning heat off directly under meat and other burner on medium, keep lid closed and check periodically, keep adding water to pan.
Sirloin Tip	4 to 5 lb.	Medium	1 to 1.5 hours	Remove cooking grid, center drip pan directly over ceramic rock, rotis with lid closed, use a meat thermometer, roast should reach 155 degrees (ask your dealer about our "INFRA BROIL" rear burner kit... there is nothing like it for rotis cooking.
Ribs		Medium Then Lo	15-20 minutes 1 to 1.5 hours	Sear ribs on HI setting briefly, then turn down to medium, place ribs in a grill safe dish to cook thoroughly. Cook via the indirect method with burner underneath pan off, and other burner on Lo. Add two cups of your favorite BBQ sauce, cover pan or wrap tightly. Be sure to check for doneness with thermometer.

*The above guide will aid you in achieving excellent cooking results. The more you use your grill the better you and the results will become. Keep in

mind that several factors such as outdoor temperature conditions, wind, humidity, altitude, size, quality and thickness of meat can influence results. Your PGS outdoor gas grill is a fun and exciting product that welcomes your involvement and creativity. Only your imagination will limit what your grill can cook!

POULTRY COOKING GUIDE

(Grill Preheated 5-10 Minutes)

Poultry, unlike beef, requires that meat be fully cooked. The guide below is only a guide; please use a quality thermometer whenever you are cooking poultry to insure proper doneness.

<u>Item</u>	<u>Amount of Meat</u>	<u>Heat Setting</u>	<u>Cooking Time for Medium Doneness</u>	<u>Cooking Tips and Methods</u>
Chicken Pieces	2 1/2 lb. to 5 lb. Serves 4 to 8 people.	LO	34-45 minutes	Preheat grill for ten minutes, grill chicken until juices run clear, turn frequently, brush with sauce during last 15 minutes if desired.
Whole Chicken	2 1/2 to 3 lb. (broiler-fryer)	Medium	60-75 minutes	Remove cooking grid, center chicken on rotis spit. Place drip pan on rocks. Balance chicken on spit rod, tie legs and wings close to body, rotis until internal temp. reaches 185 degrees. ALWAYS USE A MEAT THERMOMETER (ask you dealer about our "INFRA BROIL" rear burner kit... there is nothing like it for rotis cooking)
Whole Turkey	9 to 12 lb. serves 8 to 10	Medium	3-4 hours	Remove cooking grids. Place a drip pan filled with one to two inches of water directly on rock on one side of grill, turn heat on other side of grill, preheat grill for ten minutes. Place Turkey, with favorite stuffing, breast side up on cooking grid above pan. Use a meat thermometer to insure temperature on turkey meat reaches 185 degrees. (ASK YOUR DEALER ABOUT OUR "INFRA BROIL" REAR BURNER KIT... THERE IS NOTHING LIKE IT FOR ROTIS COOKING)

*The above guide will aid you in achieving excellent cooking results. The more you use your grill the better you and the results will become. Keep in mind that several factors such as outdoor temperature conditions, wind, humidity, altitude, size, quality and thickness of meat can influence results. Your PGS outdoor gas grill is a fun and exciting product that welcomes your involvement and creativity. Only your imagination will limit what your grill can cook!

PACIFIC GAS SPECIALTIES

Legacy Grill Series Warranty

PLEASE NOTE: ENCLOSED WARRANTY REGISTRATION CARD MUST BE RETURNED TO PGS FOR WARRANTY TO BE IN PLACE. PGS WILL NOT USE WARRANTY INFORMATION FOR ANY PURPOSE OTHER THAN INTERNAL REGISTRATION OR BULLETINS REGARDING PRODUCT IMPROVEMENTS.

PGS gas grills are made of the finest materials available and are designed to provide you and your family great outdoor cooking events. The Warranty Information below applies to residential use only. Please check our commercial warranty for coverage when our grills are installed in a commercial or multi-family installation. AEI provides you with the most comprehensive "No Hassle" warranty in the grill industry on our PGS line of grills.

LIFETIME WARRANTY

Pacific Gas Specialties warrants to the original consumer that the upper, lower, housings, stainless steel cooking grids, stainless steel warming rack and stainless steel burners will be free from defects in material and workmanship (excluding normal rust, oxidation and discoloration) when subjected to normal domestic use and service for the life of the grill.

10-YEAR WARRANTY

Pacific Gas Specialties warrants to the original consumer that the stainless steel cart, stainless steel side shelves, "Flare Guard" radiant shields, and brass valve assembly will be free from defects in material and workmanship when subjected to normal domestic use and service for a period of ten years from date of original purchase. Please note, these materials will discolor. The finish will change with long-term use. The warranty does not cover rust, scratches, normal wear and tear or oxidation of these materials.

1-YEAR WARRANTY

Pacific Gas Specialties warrants to the original consumer that the electronic "Sure Start" ignitor, all galvanized steel components, and all other parts not previously noted will be free from defects in material and workmanship when subjected to normal domestic use and service for a period of one year from date of original purchase.

WE STRONGLY RECOMMEND THAT YOU PURCHASE A PGS GRILL COVER TO PROTECT THE FINISH OF YOUR GRILL WHEN NOT IN USE.

This warranty does not include the cost of any inconvenience or property damage due to failure of the product, and does not cover damage due to misuse, abuse, accident, damage arising out of transportation of the product, or damage incurred through commercial use of the product. This express warranty is the sole warranty given by the manufacturer and is in lieu of all other warranties, expressed or implied, including implied warranty of merchantability or fitness for a particular purpose.

If you experience a warranty problem, please contact your local dealer who can exchange warranty parts. Please note that proof of purchase such as copy of sales receipt will be required. If you wish to handle your warranty claim directly with the factory, please call us at the phone numbers listed below. Upon receipt of the defective part, proof of purchase, and a check in the amount of \$25.00 for handling, we will repair or replace part and ship you replacement parts freight prepaid.



AEI CORPORATION
2641 Du Bridge Ave. P.O. BOX 16097 IRVINE, CA. 92623-6097
PH (949) 474-3070 FAX (949) 474-0559



DEFINING THE OUTDOOR GRILLING
& COMFORT HEAT EXPERIENCE

SINCE 1966

PGS GRILLS BY AEI CORPORATION
2641 Du Bridge Ave. P.O. BOX 16097 IRVINE, CA. 92623-6097
PH (949) 474-3070 FAX (949) 474-0559

PLEASE NOTE: TO INSURE WARRANTY REGISTRATION, PLEASE FILL OUT WARRANTY CARD BELOW AND RETURN MAIL. PGS WILL NOT SELL OR USE OWNER INFORMATION FOR MARKETING PURPOSES.

If you would like, you can fax this to us at 949 474-0559 or e-mail it to info@aeicorporation.com

GAS GRILL WARRANTY REGISTRATION

IMPORTANT: Please fill out this Warranty Registration within 10 days of purchase. Thank you for purchasing a Pacific Gas Specialties gas grill.

Name _____ Address _____

City, ST, ZIP _____ Phone _____

Date Purchased _____ Where Purchased (Dir. Name and City) _____

PGS Model# _____ PGS Serial Number _____

Reason for Choosing a PGS Grill:

TIMER Advertising Quality Price Features Rec by Friend Other (please write below)

This Grill Replaces:

This is our first grill Charcoal Grill

Gas Grill (Make and Model) _____

SUGGESTIONS:

-----FOLD HERE--STAPLE OR TAPE BOTTOM DROP IN MAIL-----



AEI CORPORATION
2641 DU BRIDGE AVE.
IRVINE, CA. 92714

PLACE STAMP
HERE
POSTMAN WILL NOT
DEIVER WITHOUT
POSTAGE

**AEI CORPORATION
ATTN.: PGS GRILL WARRANTY REGISTRATION DEPT.
P.O. BOX 16097
IRVINE, CALIFORNIA USA 92623-6097**

PGS LEGACY GRILLS

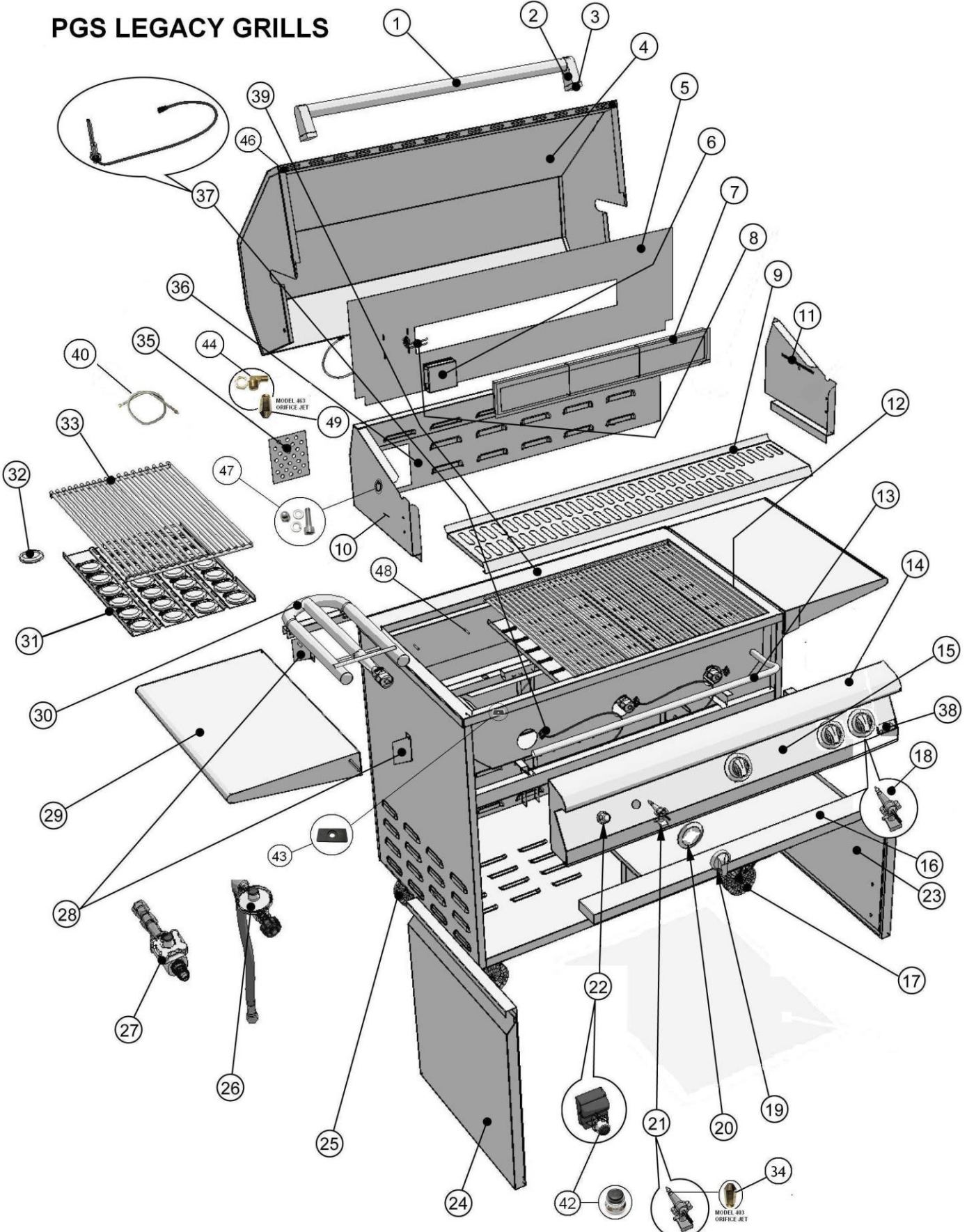

KEY#	DESCRIPTION	MODEL NUMBER				
		S27(T)	S27R	S36(T)	S36R	S48R
1	LID HANDLE	427901	427901	436901	436901	448901
2	HANDLE BRACKET 1.25"	461202	461202	461202	461202	461202
3	SPACER FOR 1.25" BRACKET	461203	461203	461203	461203	461203
4	LID	427904	427904	436904	436904	448904
5	INTERIOR REAR UPRIGHT	427905	427805	436905	436805	448805
6	COVER FOR RB ELECTRODE		404906		404906	404906
7	REAR BURNER		427907		436907	448907
8	ELECTRODE FOR REAR BURNER		402908		402908	448908
9	WARMING RACK	427909	427909	436909	436909	448909
10	INTERIOR LEFT UPRIGHT	404910	404910	404910	404910	404910
11	INTERIOR RIGHT UPRIGHT	404911	404911	404911	404911	404911
12	MANUAL LIGHTING TUBE	403912	403912	403912	403912	403912
13	MANIFOLD	427913	427813	436913	436813	448813
14	BULLNOSE	427914	427914	436914	436914	448914
15	FRONT CONTROL PANEL	427915	427815	436915	436815	448815
16	GREASE TRAY	427916	427916	436916	436916	448916
17	NON-SWIVEL CASTER F/ CARTS	409917	409917	409917	409917	409917
18	GAS VALVE FOR REAR BURNER (no orif)	403L18	FOR LP GAS	and 403N18	FOR NATURAL GAS	
19	CONTROL KNOB "SILVER" <2007	400919	400919	400919	400919	400919
19	CONTROL KNOB "BLACK" >2007	400819	400819	400819	400819	400819
19	CONTROL KNOB "RED" >2007 I/R		400719		400719	400719
20	BEZEL FOR 400919 KNOB	400920	400920	400920	400920	400920
20	BEZEL FOR 400819 400719 KNOBS	400820	400820	400820	400820	400820
21	GAS VALVES FOR MAIN BURNERS (w/orif)	403L21	FOR LP GAS	and 403N21	FOR NATURAL GAS	
22	IGNITION MODULE	402222	402322	402322	402422	402522
23	CART DOOR ASSY RIGHT HAND	427923	427923	436923	436923	448923
24	CART DOOR ASSY LEFT HAND	427924	427924	436924	436924	448924
25	SWIVEL CASTER F/ CARTS	409925	409925	409925	409925	409925
26	HOSE & REGULATOR ASSEMBLY LP	403926	403926	403926	403926	443926
27	REGULATOR ASSEMBLY NG	403927	403927	403927	403927	443927
28L	LEFT SHELF BRACKET F/CARTS	409L28	409L28	409L28	409L28	409L28
28R	RIGHT SHELF BRACKET F/CARTS	409R28	409R28	409R28	409R28	409R28
29L	LEFT SIDE SHELF FOR CARTS	409L29	409L29	409L29	409L29	409L29
29R	RIGHT SIDE SHELF FOR CARTS	409R29	409R29	409R29	409R29	409R29
30	MAIN BURNER - PRE 2007 (no crossover)	400160	400160	400160	400160	400160
30	MAIN BURNER - AFTER 2007	403930	403930	403930	403930	403930
31	GRATE FOR BRIQUETTE ROCKS	404931	404931	404931	404931	404931
32	MOON ROCK BRIQUETTES	MR56	MR56	MR84	MR84	(2) MR56
33	COOKING GRID	427933	427933	436933	436933	436933
34	ORIFICE ONLY FOR MAIN BURNERS	403L54	FOR LP GAS	and 403N43	FOR NATURAL GAS	
35	ACCESS PANEL FOR REAR BURNER		404935		404935	448935
36	EXTERIOR REAR UPRIGHT PANEL	427836	427836	436836	436836	448936
37	14" ELECTRODE FOR MAIN BURNER	402937	402937	402937	402937	402937
37	25" ELECTRODE FOR MAIN BURNER	402837	402837	402837	402837	402837
37	34" ELECTRODE FOR MAIN BURNER			402737	402737	402737
37	49" ELECTRODE FOR MAIN BURNER					442937
38	"PGS" LOGO PLATE	400938	400938	400938	400938	400938
39	MAIN BODY - FIREBOX - PIT	427939	427939	436939	436939	448939
40	FEEDLINE FOR THE REAR BURNER		427940		436940	448940
41	FEEDLINE RETENTION CLIP		401941		401941	401941
42	IGNITER "BOOT" ONLY	402942	402942	402942	402942	402942
43	INSULATING SPACER AT BULLNOSE	401943	401943	401943	401943	401943
44	ELBOW FITTING FOR REAR BURNER		401944		401944	401944
45	HEAT SHIELD FOR FIREBOX	427945	427945	436945	436945	448945
46	RUBBER BUMPER FOR LID	400946	400946	400946	400946	400946
47	HINGE BOLT ASSEMBLY	401947	401947	401947	401947	401947
48	PIN FOR ROCK GRATE SUPPORT	427948	427948	436948	436948	448948
49	ORIFICE FOR REAR BURNERS	457L49	FOR LP GAS	and 451N49	FOR NAURAL GAS	

PGS GRILLS by AEI CORPORATION
2641 Du Bridge Ave.
P. O. BOX 16097
IRVINE, CA 92623-6097
PH (949) 474-3070 FAX (949) 474-0559
Email: info@aeicorporation.com

