

This Owner's Manual is provided and hosted by [Appliance Factory Parts](http://www.appliancefactoryparts.com).



VIKING CFPIM515 Owner's Manual

[Shop genuine replacement parts for VIKING CFPIM515](#)



Appliance Factory Parts
© http://www.appliancefactoryparts.com

[Find Your VIKING Other Parts - Select From 41 Models](#)

----- Manual continues below -----

Use & Care Manual



15"W. Undercounter/Freestanding
Ice Machine

FGIM515 / CFGIM515
FPIM515 / CFPIM515

CONGRATULATIONS

Congratulations and welcome to the elite world of appliance ownership. We hope you will enjoy and appreciate the care and attention we have put into every detail of your new, state-of-the-art ice machine. Your appliance is designed to offer years of reliable service. This Use and Care Guide will provide you with the information you need to become familiar with your ice machine's care and operation.

Your complete satisfaction is our ultimate goal. If you have any questions or comments about this product, please contact the dealer from whom you purchased it, or contact our Consumer Support Center at 1-888-(845-4641).

We appreciate your choice of our ice machine and hope that you will again select our products for your other major appliance needs.

For more information about the complete and growing selection of products, contact your dealer or visit us online at vikingrange.com in the US or brigade.ca in Canada

TABLE OF CONTENTS

Important Safety Instructions	3
Initial Start Up	4
Use	4
Maintenance	5
Care and Cleaning	6
Condenser Cleaning	6
Winterizing	6
Removing the Scale from the Ice Making System	7
Troubleshooting Guide	8
Service Information	8
Warranty	9

IMPORTANT – PLEASE READ AND FOLLOW

- Before beginning, please read these instructions completely and carefully.
- **DO NOT** remove permanently affixed labels, warnings, or plates from the product. This may void the warranty.
- Please observe all local and national codes and ordinances.
- Please ensure that this product is properly grounded.
- The installer should leave these instructions with the consumer who should retain for local inspector's use and for future reference.

WARNING

To reduce the risk of fire, electric shock, or injury when using your unit, follow these basic precautions:

- Read all instructions before using the unit.
- Never allow children to operate, play with, or crawl inside the unit.
- Never clean unit parts with flammable fluids. The fumes can create a fire hazard or explosion.
- Always turn the power on/off switch (located behind the air grille on top right side) to the OFF position before attempting to change light bulbs, clean, or service the unit.

FOR YOUR SAFETY

DO NOT STORE OR USE GASOLINE OR OTHER FLAMMABLE VAPORS AND LIQUIDS IN THE VICINITY OF THIS OR ANY OTHER APPLIANCE. THE FUMES CAN CREATE A FIRE HAZARD OR EXPLOSION.

It is your responsibility to be sure your ice machine is:

- located so the front is not blocked to restrict incoming or discharge air flow.
- properly leveled.
- located in a well ventilated area.
- connected to the proper kind of outlet, with the correct electric supply and grounding. A 115V, 60 Hz, 15 amp fused electrical supply is required. **Note:** *Time delay fuse or circuit breaker is recommended.*
- not used by anyone unable to operate it properly.
- used only for its intended purpose.
- properly maintained.

•SAVE THESE INSTRUCTIONS•

INITIAL START UP

1. Turn on the water supply.
2. Switch on the electrical power.
3. Push and release the On/Off switch to start the machine. The Ice Making light next to the On/Off switch will glow Blue.
4. Water will begin to flow into the unit. When the reservoir is full, water will start to drain from the machine. After a few minutes the compressor, water pump and fan motor will begin to operate and the first ice making cycle will have begun.

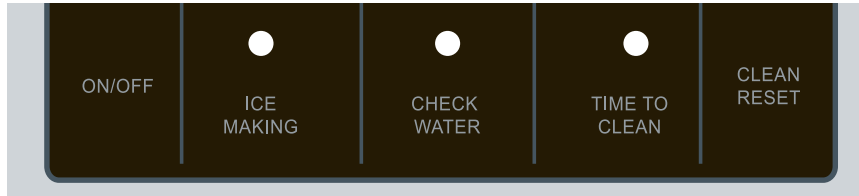

No adjustments are needed.

After about half an hour, ice will fall into the ice storage bin. The machine makes 24 cubes per batch. It is normal for the first batches of ice to melt, that continues until the bin has cooled. It will take 8 to 10 hours of continuous run time to fill the ice bin. When the bin is full of ice, the ice machine will shut off. It will automatically restart when the ice level falls, either from use or normal meltage.

USE

No special instructions are needed for use. Just take as much ice as you need, the machine will replace it. A scoop is provided, and it can be stored in the machine using the loop of tubing on the right side as a holder. That tubing is also the ice level sensor; ice will fill the storage bin until it is near to or on that tube and then the machine will shut off.

The machine can be shut off anytime by just pushing and releasing the On/Off button. The machine will shut off at the end of the next cycle. To shut off immediately, push and hold the On/Off button in until the machine stops.

Never keep anything in the ice storage bin that is not ice. Objects like wine or beer bottles are not only unsanitary, but the labels can slip off and plug up the drain.

Never allow the machine to operate without regular cleaning. The machine will last longer if it is kept clean. Regular cleaning should happen at least once per year, and preferably twice. Some water conditions will dictate even more frequent cleaning of the ice making section, and some carpets or pets will dictate more frequent cleaning of the condenser.

Note: The Time to Clean light will switch ON after 6 months of use. It will remain ON until the ice making system is cleaned using the process in the "How to clean the condenser and winterize" section.

Noise

The ice machine is designed for quiet operation, but will make some noise during the ice making cycle. During a freezing cycle, it is normal to hear the fan moving air and the water pump circulating water. Ice hitting the bin or ice in the bin can be heard during harvest. If ice making noise is objectionable, an appliance grade timer can be added to the power supply. Set the timer to turn the machine off at the time(s) of day when the noise is most objectionable.

Normal cubes are tapered cylinders. If the cubes are ragged and mis-shaped, mineral scale must be removed from the ice making system.

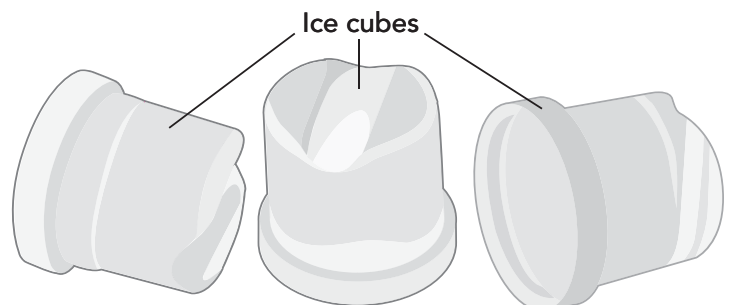

WATER QUALITY

All water, including potable water supplied by municipalities, contains some impurities or minerals. Water absorbs impurities from the air as rain and/or as it flows through the ground. Some of the impurities are solid particles, these are known as suspended solids, and a fine particle filter will remove them. Other impurities are chemically bonded to the water molecules, and cannot be filtered out, these are called dissolved solids.

Ice made by this machine will have a lower mineral content than the water it was made from. This is due to the method of making ice. Purer water will freeze first in the ice making molds. The reason for this is that anything dissolved in water lowers the water's freezing temperature. This concentrates most of the impurities in the ice machine water reservoir where they may form hard deposits known as scale. The machine dilutes the concentration of minerals by over-filling the reservoir during the harvest cycle (with the excess water flowing down the drain). s. Between 2 and 4 pints of water flow into the unit each cycle. Between 1 and 3.5 pints of that rinses the reservoir and goes down the drain.

Some impurities will inevitably remain, and will stick to the parts in the machine, and will cause malformed ice cubes. Eventually, built up mineral scale can shorten machine life.

To keep the machine operating properly, these impurities or minerals will have to be regularly dissolved by an acid cleaning, using Ice Machine Scale Remover. Directions for this may be found in the section under care and cleaning.

MAINTENANCE

There are 5 things to keep clean:

1. The outside cabinet & door.
2. The ice storage bin.
3. The condenser.
4. The ice making system.
5. The ice scoop.

How to clean the cabinet

Wipe off any spills on the surface of the door and handle as they occur. If anything spilled on the door or gasket dries onto the surface, wash with soap and warm water to remove.

How to clean the ice storage bin

The ice storage bin should be sanitized occasionally. It is usually convenient to sanitize the bin after the ice making system has been cleaned, and the storage bin is empty.

A sanitizing solution can be made of 1 ounce of household bleach and two gallons of hot (95° F. – 115° F.) water. Use a clean cloth and wipe the interior of the ice storage bin with the sanitizing solution, pour some of the solution down the drain. Allow to air dry.

CARE AND CLEANING

Condenser cleaning

The condenser is like the radiator on a car, it has fins and tubes that can become clogged with dirt and lint.

To clean:

1. Remove the kickplate and front service panel.
2. Locate the condenser surface.
3. Vacuum the surface, removing all dust and lint.
4. Return the kickplate and front service panel to their original positions. Fasten them to the cabinet using the original screws.

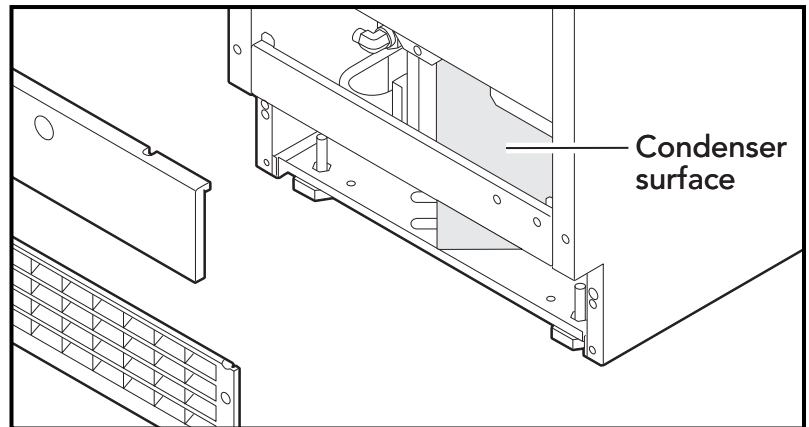

Winterizing

1. Clean the ice making system.
2. Open the door and push and release the On/Off switch to turn the machine off.
3. Turn off the water supply.
4. Drain the water reservoir by removing the rubber cap under the reservoir - it's near the back wall of the ice storage bin.

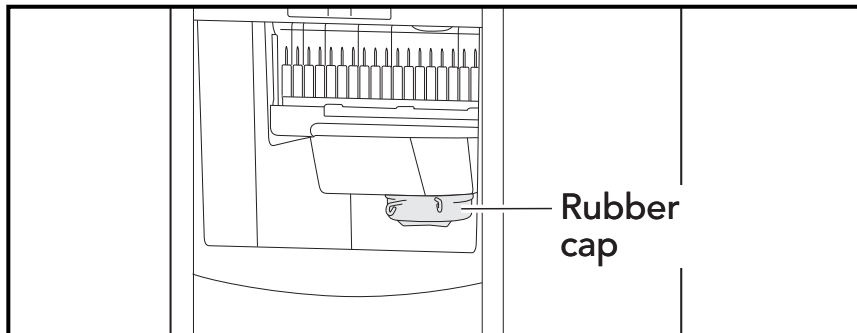

5. Disconnect the incoming water line at the inlet water valve.
6. Open the door, push and release the on/off switch to turn the machine on.
7. Blow air through the inlet water valve; a tire pump could do the job.
8. Drain pump models should have about 1/2 gallon of RV antifreeze (propylene glycol) poured into the ice storage bin drain.
Note: Automotive antifreeze must **NOT** be used.
9. Switch off and unplug the machine.

Removing scale from the ice making system

1. Scoop out all of the ice, either discard it or save it in an ice chest or cooler.
2. Press and HOLD the On/off button in for 3 seconds until the Blue light goes out.

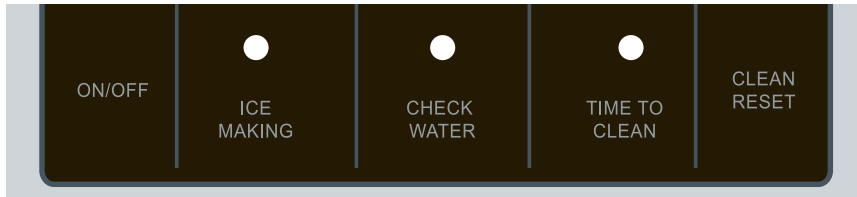

3. Press and HOLD the both the Clean-Reset and On/Off buttons for 5 seconds. The Time to Clean light will blink on and off.
4. Pour 8 ounces of Ice Machine Scale Remover into the ice machine reservoir.

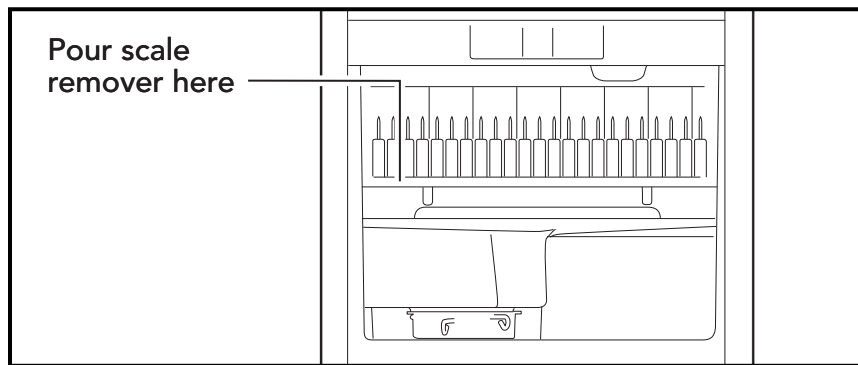

5. Operate the machine for about ½ hour.
6. Push and release the On/Off switch. The Time to Clean light will stop blinking and remain on. The machine will begin to flush out the cleaning solution.
7. Operate the machine for another 1/2 hour.
8. Push and release the On/Off switch. The machine will stop the cleaning process.
9. Pour a gallon of hot (95°F. – 115°F.) water into the bin to flush out the drain.
10. Clean the bin liner of mineral scale by mixing some ice machine scale remover and hot water, and using that solution to scrub the scale off of the liner.
11. Rinse the liner with hot water.
12. Sanitize the bin interior.
13. Replace the ice removed in step 1.
14. Push and release the On/Off button to restart ice making.

The ice scoop should be washed regularly, wash it just like any other food container.

TROUBLESHOOTING GUIDE

PROBLEM	CORRECTION
Ice cubes are incompletely formed	<ul style="list-style-type: none"> • Clean the ice making system.
Low capacity	<ul style="list-style-type: none"> • Check for restricted drain or standing water in the bin. • Clean the air cooled condenser fins.
No ice	<ul style="list-style-type: none"> • Check On/Off switch. • Check electrical breaker. • If the "Check Water" light is flashing blue, check water supply. The control system checks for water every 20 minutes. When the water supply is restored, the machine will automatically restart ice making.
"Time to Clean" light is on	<ul style="list-style-type: none"> • Clean the ice making system

Service Information

If service is required after checking the troubleshooting guide, call your authorized service agency.

When you make a service call, be sure to have the following information handy:

- Model Number
- Serial Number
- Date of Purchase
- Name of dealer from whom purchased

Be ready to clearly describe the problem that you are having with your ice machine.

If you are unable to obtain the name of an authorized service agency, or if you continue to have service problems, contact Viking Range, LLC at 1-888-845-4641 or write to:

**VIKING RANGE, LLC
PREFERRED SERVICE
111 Front Street
Greenwood, Mississippi 38930 USA**

Record the following information indicated below. You will need it if service is ever required.

The serial number and model number for your ice machine is located under the control panel in the upper compartment.

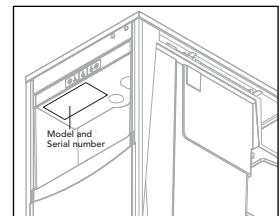

Model No. _____ Serial No. _____

Date of Purchase _____ Date Installed _____

Dealer's Name _____

Address _____

If service requires installation of parts, use only authorized parts to insure protection under the warranty.

Keep this manual with your ice machine for future reference.

FGMI/FP<I UNDERCOUNTER/FREESTANDING ICE MACHINE WARRANTY TWO YEAR FULL WARRANTY

Undercounter/freestanding ice machines and all of their components and accessories, except as detailed below*, are warranted to be free from defects in material or workmanship under normal household use for a period of two (2) years from the date of original retail purchase. Viking Range, LLC, warrantor, agrees to repair or replace, at its option, any part which fails or is found to be defective during the warranty period

*Painted and decorative items are warranted to be free from defective materials or workmanship for a period of ninety (90) days from the date of original retail purchase. ANY DEFECTS MUST BE REPORTED TO THE SELLING DEALER WITHIN NINETY (90) DAYS FROM DATE OF ORIGINAL RETAIL PURCHASE.

***FULL NINETY (90) DAY COSMETIC WARRANTY:** Product is warranted to be free from cosmetic defects in materials or workmanship (such as scratches on stainless steel, paint/porcelain blemishes, etc.) for a period of ninety (90) days from the date of original retail purchase or closing date for new construction, whichever period is longer. Any defects must be reported to the selling dealer within ninety (90) days from date of original retail purchase. Viking Range, LLC uses high quality processes and materials available to produce all color finishes. However, slight color variation may be noticed because of the inherent differences in painted parts and porcelain parts as well as differences in kitchen lighting, product locations, and other factors. Therefore, this warranty does not apply to color variation attributable to such factors.

†FULL NINETY (90) DAY WARRANTY IN "RESIDENTIAL PLUS" APPLICATIONS: This full warranty applies to applications where use of the product extends beyond normal residential use, but the warranty period for products used in such applications is ninety (90) days. Examples of applications covered by this warranty are bed and breakfasts, fire stations, private clubs, churches, yachts, etc. Under this "Residential Plus" warranty, the product, its components and accessories are warranted to be free from defective material or workmanship for a period of ninety (90) days from the date of original retail purchase. This warranty excludes use of the product in all commercial locations such as restaurants, food service locations and institutional food service locations.

SIX YEAR FULL WARRANTY ON SEALED REFRIGERATION PARTS AS LISTED

Any sealed refrigeration system component, as listed below, is warranted to be free from defective materials or workmanship in normal household use during the third through the sixth year from the date of original retail purchase. Viking Range, LLC, warrantor, agrees to repair or replace, at its option, any part which fails or is found to be defective during the warranty period.

Sealed Refrigeration System Components: Compressor, Evaporator, Condenser, Connecting Tubing, Dryer/Strainer

TWELVE YEAR LIMITED WARRANTY ON SEALED REFRIGERATION PARTS AS LISTED

Any sealed refrigeration system component, as listed above, which fails due to defective materials or workmanship in normal household use during the seventh through the twelfth year from the date of original retail purchase will be repaired or replaced, free of charge for the part itself, with the owner paying all other costs, including labor.

LIMITED LIFETIME WARRANTY

During the life of the product, any stainless steel parts found to be defective in material or workmanship will be repaired or replaced, free of charge for the part itself, with the owner paying all other costs including labor. This warranty excludes surface corrosion or rust, scratches, discoloration, water or atmospheric conditions, or cleaning practices which are part of normal residential use.

TERMS AND CONDITIONS

This warranty extends to the original purchaser of the product warranted hereunder and to each transferee owner of the product during the term of the warranty and applies to products purchased and located in the United States, Canada, Mexico, and the Caribbean (excluding Cuba, Dominican Republic, and Haiti). Products must be purchased in the country where service is requested. If the product or one of its component parts contains a defect or malfunction during the full warranty period after a reasonable number of attempts by the warrantor to remedy the defect or malfunction, the owner is entitled to either a refund or replacement of the product or its component part or parts. Replacement of a component part includes its free installation, except as specified under the limited warranty. Under the terms of this warranty, service must be performed by a factory authorized Viking Range, LLC service agent or representative. Service will be provided during normal business hours, and labor performed at overtime or premium rates shall not be covered by this warranty.

Owner shall be responsible for proper installation, providing reasonable and necessary maintenance, providing proof of purchase upon request, and making the appliance reasonably accessible for service. The return of the Owner Registration Card is not a condition of warranty coverage. You should, however, return the Owner Registration Card so that Viking Range, LLC can contact you should any question of safety arise which could affect you.

This warranty gives you specific legal rights, and you may also have other rights which may vary from jurisdiction to jurisdiction.

Viking Range, LLC
111 Front Street
Greenwood, Mississippi 38930 USA
(662) 455-1200

For product information,
call 1-888-(845-4641)
or visit our web site at vikingrange.com in the US or brigade.ca in Canada