

# Washing Machine

*Dear ASKO Customer,*

*Thank you for choosing this Scandinavian quality product made in Vara, Sweden.*

*We want you to feel confident that the inside of your new machine is just as good as the outside, and that the ethical and moral principles with which we have built this machine are as high as the quality and performance that you will obtain from it. We hope that our product will keep you happy for many years to come.*

*To derive the best possible benefit from your new machine, we recommend that you read this Installation and User Guide before using the machine.*

**ASKO W6021**

# CONTENTS

---

<b>READ FIRST</b>	<b>Page</b>
<b>1 Before washing the first time</b>	<b>3</b>
<b>2 Safety instructions</b>	<b>4</b>
General, Installation, Washer door, Interrupting a program, Overfill protection, Packing material, Transport/Winter storage, Disposal	
<b>3 Children's safety</b>	<b>5</b>
Child-safe washing, Protect children, Child safety catch on detergent compartment, Child safety catch on temperature knob	
<b>4 Parts of the washer</b>	<b>6</b>
<b>5 Detergent compartment</b>	<b>6</b>
<b>6 Panel</b>	<b>7</b>

## **INSTALLATION**

---

See instructions for installation.

## **WASHING**

---

<b>7 Before washing</b>	<b>8-10</b>
Sorting the washing, Garments, Recommended garment labelling, Coloured cotton, Delicate washing, Minimizing allergy hazards, Save time, Economy and efficiency, Detergents, Textile dyeing	
<b>8 Washing</b>	<b>11-14</b>
Instructions – step-by-step, Available programs	
<b>9 Consumption values</b>	<b>15</b>

<b>CARE</b>	<b>Page</b>
<b>10 Care and Cleaning</b>	<b>16-17</b>
Cleaning the needle trap and drain pump., detergent compartment, outside of the machine, Clean-out the recess under the ridges, Cleaning the inside of the machine to prevent problems with odour, If you have hard water	

## **PROBLEMS?**

---

<b>11 Trouble shooting</b>	<b>18-19</b>
Machine will not start, Washer door will not close, Washer door will not open, Machine will not take in water after starting, Machine will not spin, Water remains in the machine at the end of washing, Programs take too long	

## **MISCELLANEOUS**

---

<b>12 Technical information</b>	<b>20</b>
Technical data, Standard tests	
<b>13 Service and guarantee</b>	<b>21</b>
<b>14 Quick guide</b>	<b>22</b>
<b>15 Index</b>	<b>23</b>

# 1 BEFORE WASHING THE FIRST TIME

---

## **CAUTION WITH CERTAIN MATERIALS**

Always check and adhere to recommended garment labelling on the items concerned. If no recommendations are given, refer to those in Chapter 7, Before washing.

## **TRANSPORT SUPPORTS**

Are the transport supports removed? If not, see the Installation instructions.

## **WASHER DOOR**

The door of the washer opens electrically. Consequently, the door cannot be opened normally until the machine is connected to an electric power supply. However, emergency opening is available, see Chapter 11, Trouble shooting.

## **CHECK HARDNESS OF THE WATER**

Call your local water company to find out what degree of water hardness applies. This has significance in relation to the amount of detergent that should be used.

For brief operating instructions, see Chapter 14, Quick guide.

## 2 SAFETY INSTRUCTIONS



### GENERAL

- Study and save this Use and Care Guide for future reference.
- Electrical and water installation, if required, must be carried out by authorised persons.
- The machine may only be used for washing in accordance with this Use and Care Guide - not for dry cleaning.
- Use only detergents intended for machine washing.
- Remove the transport supports before using the machine, see installation instructions.
- Repairs and maintenance undertaken for reasons of safety and performance must be carried out by authorised persons.

### INSTALLATION

See the accompanying installation instructions.

### WASHER DOOR

The door of the washer opens electrically. Consequently, the door cannot be opened normally until the machine is connected to an electric power supply.

To open the door manually, see the heading, Door will not open, in Chapter 11, Trouble shooting.

The machine cannot be started with the door open.

To open the door during operation, see below, Interrupting a program.

### INTERRUPTING A PROGRAM

To interrupt a washing program, press the  $\frac{\text{Start}}{\text{Stop}}$  button for three seconds. If any water remains in the machine, run either the Drain or the Spin program. Any water will then be pumped

out. Then press the  $\text{⏏}$  button to open the door. To restart: fill with new detergent, if required, and select a new program.

### OVERFILL PROTECTION

If the level of water in the machine rises above normal, the overflow protection will start to pump out water and shut off the water supply. The program will be interrupted if the level does not fall within 60 seconds.

### PACKING MATERIAL

Sort the packing material for recycling according to recommendations by the local authorities.

### TRANSPORT/WINTER STORAGE

If the machine is to be transported or stored in unheated premises where the temperature can drop below zero, you should adopt the following procedure:

- Empty the needle trap and the drain pump; see Chapter 10, Care and cleaning.
- Turn off the water supply to the washing machine, disconnect the supply hose to the inlet valve, and allow the water to run out from the valve and the hose.

### DISPOSAL

Contact your refuse collection service or your local authorities for advice on how to scrap the machine in a proper manner for recycling.

The machine is made and marked to facilitate recycling.

# 3 CHILDREN'S SAFETY



## **CHILD-SAFE WASHING**

Always close the washer door and start the program immediately after filling with detergent.

Do not allow children to play with the washing machine.

## **PROTECT CHILDREN**

Keep detergents and conditioner out of the reach of children.

## **CHILD SAFETY CATCH ON DETERGENT COMPARTMENT**

On the right in the handle of the detergent compartment there is a disengageable safety catch to prevent children from opening the compartment.

### **Engaging the child safety catch**

To engage the child safety catch, pull the detergent compartment out a little so that you can reach the catch. Pull the catch towards you and then release it.

### **Child safety catch engaged**

To open the compartment when the child safety catch is engaged you must push the catch to the left while pulling out the compartment.

### **Disengaging the child safety catch**

To disengage the child safety catch, push the catch to the left and then towards the back of the machine.

## **CHILD SAFETY CATCH ON TEMPERATURE KNOB**

Underneath the temperature knob there is a disengageable safety catch to prevent operation by children. A flat-bladed screwdriver is needed to engage or disengage the catch.

### **Engaging the child safety catch**

Insert the screwdriver in the hole of the catch. Press the screwdriver upwards and turn clockwise at the same time, release the catch down and turn back.

### **Child safety catch engaged**

The child safety catch protrudes when it is engaged. To alter the temperature setting when the catch is engaged:

- push the catch up.
- turn the temperature knob to the desired setting.
- release the catch.

### **Disengaging the child safety catch**

To disengage the child safety catch, push the catch up and turn clockwise at the same time. When the catch is at its highest position turn back so that the catch remains pressed in.

# 4 PARTS OF THE WASHER

---

1. DETERGENT COMPARTMENT

2. MAIN POWER SWITCH

3. PROGRAM PANEL

4. DATA PLATE

5. COVER - DRAIN PUMP

6. DRAIN PUMP (BEHIND THE COVER)

7. WASHER DOOR

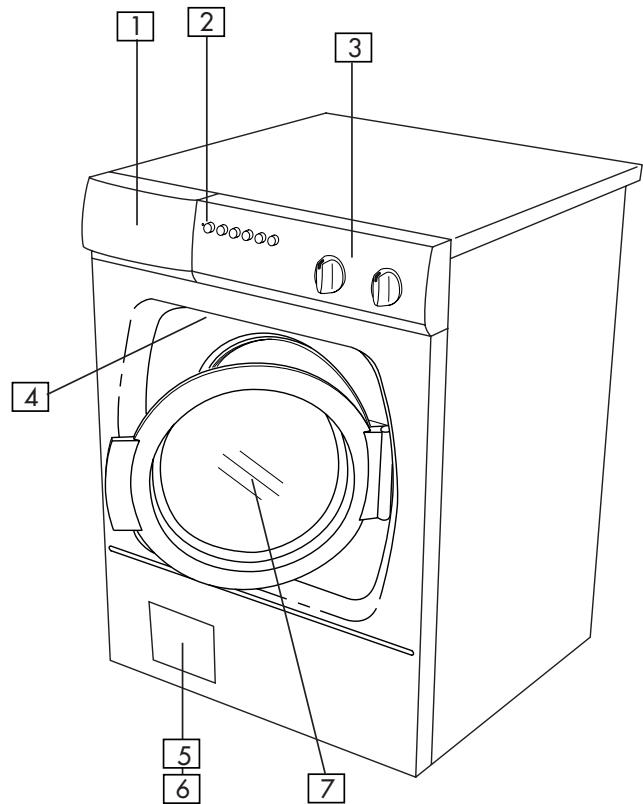

# 5 DETERGENT COMPARTMENT

---

1. DETERGENT COMPARTMENT - PRE-WASH

2. DETERGENT COMPARTMENT - MAIN WASH

3. CONDITIONER COMPARTMENT

4. DETERGENT DIVIDER (LOCATED UNDERNEATH)

5. CHILD SAFETY CATCH

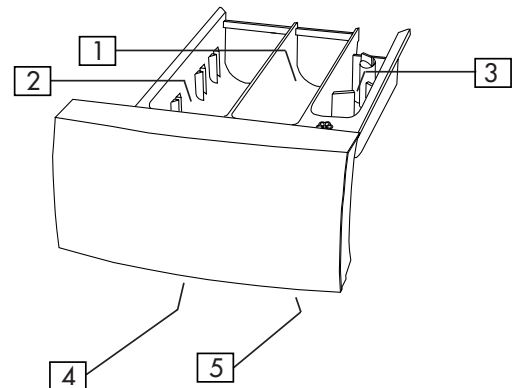

# 6 PANEL

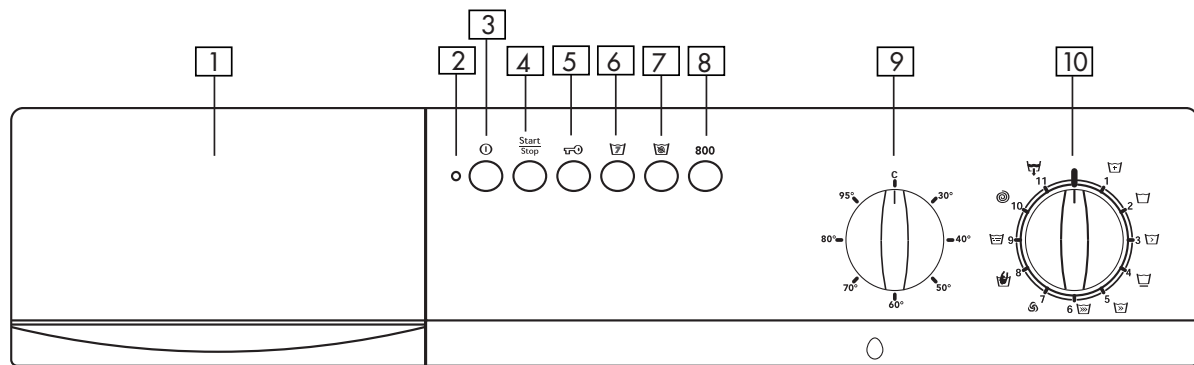

---

1. DETERGENT COMPARTMENT

---

2. INDICATING LAMP ON/OFF

---

3. MAIN POWER SWITCH

---

4. START/STOP BUTTON

---

5. DOOR OPENING

---

6. SUPER RINSE

---

7. NO SPIN / NO DRAIN

---

8. SPIN SPEED 800 REVS PER MIN

---

9. TEMPERATURE KNOB

---

10. PROGRAM SELECTOR KNOB. THE PROGRAMS ARE DESCRIBED IN THE TABLE IN CHAPTER 8, WASHING

---

# 7 BEFORE WASHING

Before you start washing, here is some advice that can be useful.

## SORTING THE WASHING

Sort garments in relation to:

- How soiled they are
- Colour
- Material

## GARMENTS

- Close zip-fasteners so that they do not chafe against other items.
- New coloured garments can have surplus dye and should therefore be washed separately the first time.
- Turn garments inside out. This reduces the risk of burling and dye creases.
- Empty pockets and suitably let them wash turned inside out.

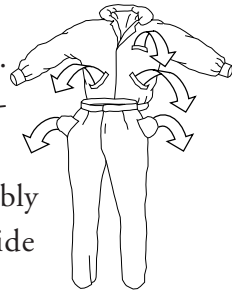

## RECOMMENDED GARMENT LABELLING

Check the recommended labelling. The table below gives useful information on suitable washing programs for different materials and amounts of washing.

### COLOURED COTTON

Coloured cotton garments marked with a recommendation for 60°C should the first time be washed at 60°C to get rid of any surplus dye. If this advice is ignored there is a risk that colours will run. Use a detergent without bleach to safeguard the colours.

### DELICATE WASHING

#### Unbleached linen

Unbleached linen should be washed at 60°C using a detergent without bleach or optical whitening agent. Severely soiled linen can occasionally be washed at a higher temperature, but not too often because heat can destroy the lustre and strength of linen.

## Symbols in washing instructions

WASHING LABEL	MATERIAL	PROGRAM	LOAD
	Cotton, linen, white and light colours	Normal wash 60°C to 95°C	1/1 drum
	Cotton, linen. Darker colours	Normal wash 60°C	1/1 drum
	Polyester, cotton/polyester, nylon. Whites	Synthetic wash 60°C	1/2 drum
	Rayon, acetates, acrylics. Sensitive colours	Synthetic wash 40°C	1/2 drum
	Polyesters, cotton/polyester, nylon. Colours	Synthetics wash 40°C	1/2 drum
	Silk and very delicate items	Synthetic wash 30°C	1/3 drum
	Items marked IWS and Superwash	Wool/hand wash 40°C	1/3 drum



### Wool and silk

Wool and silk are sometimes marked machine wash, and sometimes hand wash. The Wool and Hand wash programs of the machine are at least as gentle as washing by hand.

Wool is particularly sensitive to mechanical processing. If you wish to avoid spin drying, you can press out the water instead using terry towelling. In this case, you should select  (No Spin/No Drain). Once the program is complete, you should then run the Drain program.

Most garments will tolerate a short spin, however. The Wool and Hand wash programs automatically include a short spin.

### Man-made fibres and synthetic fibres

These materials require a lot of space if they are not to crease. Fill the drum only to half load when washing man-made/synthetic fibres. Select a short spin by selecting **800**.

#### NOTE

---

Viscose and acetate are brittle when wet.

### MINIMISE THE RISK OF ALLERGY

This washing machine offers a Super rinse option . You should use this if you have sensitive skin, for example people with allergies and infants.

### SAVE TIME

Use the Light wash program to save time. This program has a shorter main wash than Normal wash, but it is often sufficient for normally soiled washing.

### ECONOMY AND EFFICIENCY

Select Super quick wash if you simply need to freshen up shirts or training kit, etc. You will save both water and energy.

### DETERGENTS

Overdosing detergent will not give better results, it only increases the burden on the environment.

Try using less detergent, and increase the dose only if you are displeased with the washing results.

### FABRIC DYEING

If you want to dye fabrics in the machine, select Normal wash and Super rinse, . Choose the temperature recommended by the dye manufacturer.

If the fabrics to be dyed are cotton/polyester mixtures, you should select  (No spin/No Drain). Once the program is complete, you can run the Spin program by holding down the **800** button to spin the fabrics at low speed.

#### NOTE

---

Bleaches or stain removers that contain the chemical  $\text{Na}_2\text{S}_2\text{O}_4$ , known as sodium dithionite or sodium hyposulphite, must not be used in this washing machine. If these substances are used they could cause corrosion and discoloration.

#### NOTE

---

Put the dye directly in the drum - not in the detergent compartment. After dyeing, the empty machine should be run using the same program. Use a normal amount of detergent.

---

This page has been left blank for technical printing reasons.

---

# 8 WASHING

The following step-by-step instructions are provided to help you to achieve the best possible washing result.

## 1 SORT THE WASHING

For tips and advice, see Chapter 7 – Before washing.

### NOTE

Empty the pockets. Coins, nails and similar items can cause damage to the machine and textiles.

## 2 TURN ON THE MAIN POWER SWITCH ①.

## 3 OPEN THE DOOR AND PUT IN THE WASHING.

Press the  button once, and the door will open after three seconds. Put in the washing.

The table below the washing program indicates how much washing you can put in for each program.

## 4 PUTTING IN THE DETERGENT AND CONDITIONER

Follow the recommendations on the detergent packet for how much detergent should be used. The capacity of the machine is for 6.0 kg washing. If you put a smaller amount in the machine, you can reduce the amount of detergent accordingly.

### Powder detergent

Pour in the powder for main wash (2) and any pre-wash (1).

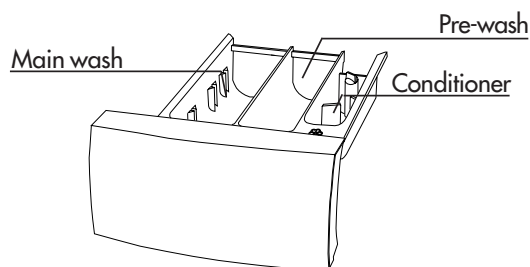

### Liquid detergent

A partition divider for liquid detergent is provided, you will find it attached underneath the detergent compartment. Take it and insert it in the slot furthest in in the compartment as illustrated. Pour the detergent directly into the main wash compartment (2).

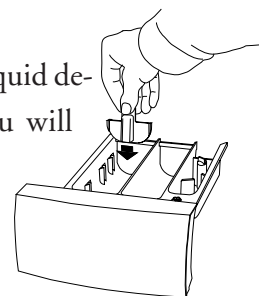

### Detergent ball or dosing bag

If you are using a detergent ball or dosing bag, put it in with the washing and select a program without pre-wash.

### Conditioner

Pour conditioner into the compartment marked . Follow the maker's instructions regarding the amount.

### NOTE

Do not exceed the maximum dose level of the container, the conditioner will otherwise flow in too soon and deteriorate the washing effect.





## 5 SELECT A PROGRAM

Select the program that you wish to use with the program selector knob. You can select between the following programs:

- 1 Heavy wash (with pre-wash)
- 2 Normal wash
- 3 Light wash
- 4 Synthetic wash
- 5 Quick wash
- 6 Super quick wash
- 7 Wool wash
- 8 Hand wash
- 9 Rinse program
- 10 Spin
- 11 Drain

The table on the following page contains more information about the programs.

## 6 SELECTING SETTINGS AND OPTIONS

You can obtain a washing program to suit your particular wash by setting the temperature knob and pressing the appropriate option buttons.

### Temperature

Set the desired temperature with the temperature knob. If you select C, the wash temperature will be the same as that of the incoming water.



For certain programs, the maximum temperature is always 40°C; see the table below.

### Spin

The normal spin speed is 1200 revolutions/minute (long spin).

By pressing the **800** button, you can select a

lower spin speed of 800 revolutions/minute (short spin).

By pressing the  button, the program will be executed without a spin and will be completed without draining. The fabrics will thus remain floating in the water and will not crease. On completion of the program, disconnect  and select either the Spin or Drain program to drain the rinsing water from the machine.

### Super rinse



Press the  button to select the Super rinse option.

Super rinse adds extra rinses to the washing programs; see the table.

## 7 STARTING THE PROGRAM

Close the washer door, and start the program with the  button. It will take a few seconds before you hear the machine starting.

### Interrupt the program

To interrupt the program, press the  button for three seconds. If any water remains in the machine, run either the Drain or the Spin program. Any water will then be pumped out. Then press the  button to open the door. To restart: fill with new detergent, if required, and select a new program.

### Alter settings during the program

Press in/out the option buttons that you wish to alter, or turn the temperature knob to the desired setting.

## AVAILABLE TYPES OF PROGRAM

Program information		Program content							Other					
Program No.	Program	Max. quantity	Temperature °C (A)	Max. spin speed rev/min	Pre-wash	Main wash	Spin	Rinse (B)	Spin	Rinse (B)	Spin	Rinse (B)	Spin	
1	Heavy wash	●	C,30-95	1200	■	■	⊙	⊙	⊙	⊙	⊙	⊙	⊙	
2	Normal wash	●	C,30-95	1200		■	⊙	⊙	⊙	⊙	⊙	⊙	⊙	Shorter main wash than for Normal wash.
3	Light wash	●	C,30-95	1200		■	⊙	⊙	⊙	⊙	⊙	⊙	⊙	
4	Synthetic wash	◐	C,30-95	800		■	⊙	⊙	⊙	⊙	⊙	⊙	⊙	
5	Quick wash	●	C,30-95	1200		■	⊙	⊙	⊙	⊙	⊙	⊙	⊙	
6	Super quick wash	◐	C,30-95	1200		■	⊙	⊙	⊙	⊙	⊙	⊙	⊙	
7	Wool wash (C)	◐	C,30-40	800		■	⊙	⊙	⊙	⊙	⊙	⊙	⊙	
8	Hand wash (C)	◐	C,30-40	800		■	⊙	⊙	⊙	⊙	⊙	⊙	⊙	Slightly more gentle than Wool wash.
9	Rinse program	●		1200			⊙	⊙	⊙	⊙	⊙	⊙	⊙	
10	Spin	●		1200									⊙	
11	Drain	●	Pumping only											

- 1/1 (6,0 kg)
- ◐ 1/2 (3,0 kg)
- 1/3 (2,0 kg)

- Wash
- ⊙ Rinse

- ⊙ Short spin (always 800 r/min)
- ⊙ Long spin

(A) C in the display denotes the temperature of the incoming water.

(B) With the Super Rinse On option: For programs 1-3, four extra rinses will be included, and one spin will be omitted. For programs 4-8: two extra rinses will be included before the final ordinary rinse.

(C) Delicate wash – high water level.

WM334-3







In order to make an alteration, however, the part of the program that you wish to alter must not have been activated yet.

- Program – the program is not affected when the program knob is operated. Interrupt the program instead.
- Temperature – can be altered before the temperature has been reached in the main wash.
- Spin speed – before the machine enters spin mode.
- Super rinse – before the machine enters rinse mode.

## **8 PROGRAM COMPLETED**

The program is complete when the door can be opened with the  button. If you have selected a program without spinning, and if water remains in the machine, run the Spin or Drain program to enable the door to be opened.

## **9 WHEN WASHING IS FINISHED**

Turn off the main power switch  and close the washer door to prevent small children from crawling into the machine.

## 9 CONSUMPTION VALUES

The following conditions apply for the consumption values indicated below:

Temperature of incoming water: 15°C. Element power: 2000 W. Options: None

PROGRAM	MATERIAL/WASHING TEMPERATURE(1)	LOAD (2)	WATER CONSUMPTION (approx. litre)	POWER CONSUMPTION (approx. kWh)	PROGRAM TIME (approx. minutes)
Heavy wash	Cotton, linen, 60°C	5,0 kg	52	1,20	135
Normal wash	Cotton, linen, 60°C	5,0 kg	49	0,95	120
Light wash	Cotton, linen, 60°C	5,0 kg	49	0,90	80
Synthetic wash	Polyester, cotton / polyester, nylon, 40 C	3,0 kg	28	0,35	65
Quick wash	Cotton, linen, 60°C	5,0 kg	35	0,90	58
Super quick wash	Polyester, cotton / polyester, nylon, 40 C	3,0 kg	22	0,30	35
Wool wash	Wool/Hand wash, IWS, Superwash, 30°C	2,0 kg	54	0,30	40
Hand wash	Wool/Hand wash, IWS Superwash, 30°C	2,0 kg	54	0,30	40
Rinse program	Cotton, linen	5,0 kg	7-12	0,05	15
Spin	Cotton, linen	5,0 kg	----	0,05	10
Drain	Cotton, linen	5,0 kg	----	----	1

(1) All programs are set to the highest available spin speed.

(2) The machine can handle a maximum load of 6.0 kg.

# 10 CARE AND CLEANING

---

## CLEANING THE NEEDLE TRAP AND THE DRAIN PUMP

The washing machine has a trap in which coins, hairpins and similar items fasten. Clean the needle trap and the drain pump as follows:

1. Ensure that the machine is drained and the main power switch is turned OFF.

2. Open the drain pump cover. Use the partition piece from the detergent compartment, as illustrated.

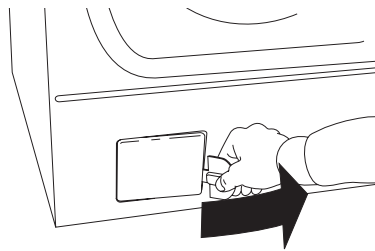

3. Drain off the water, eg, in a bowl, by pulling loose the drain hose from its connection on the inside of the cover.

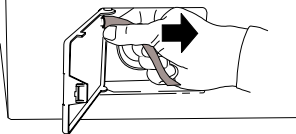

4. Open the pump by screwing its cover anticlockwise. Pull out the cover together with the needle trap.

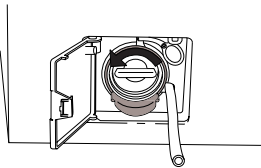

5. Clean out any objects and foreign matter from the pump housing. Ensure that the pump blade, at the rear, can be rotated.

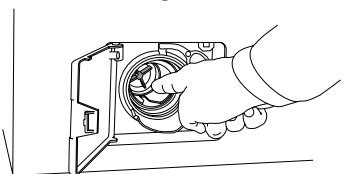

6. Screw on the cover together with the needle trap, put the drain hose back on its connection and close the door.

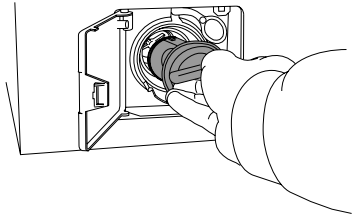

## CLEANING THE DETERGENT COMPARTMENT

Pull out the detergent compartment as far as it goes.

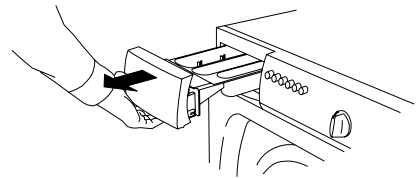

Then pull upwards and outwards as illustrated.

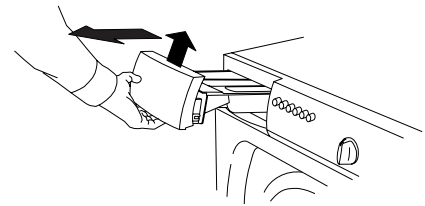

Flush and brush the detergent compartment. Put the detergent compartment back in.

### NOTE

Do not wash the detergent compartment in a dishwasher.

## CLEANING THE OUTSIDE OF THE MACHINE

Use a mild detergent to clean the outside of the machine. Do not use any solvents, they can damage the machine.

### NOTE

Do not spray the machine with water.



### **CLEANING THE INSIDE OF THE MACHINE TO PREVENT PROBLEMS WITH ODOUR**

Today's modern detergents mean that washing at low temperatures is often sufficient. However, this can result in small deposits forming inside the machine. These can eventually lead to odour problems.

To avoid these problems, we recommend running a 95° program on a few occasions each year. You should use a small quantity of detergent at the same time. It is not necessary to fill the machine with washing.

### **CLEANING HOLES UNDER THE RIDGES**

If you suspect that objects, eg, nails, paperclips, pins and so on, have fallen through the washing drum you should check the space underneath the ridges. Such items can corrode and cause rust stains on your washing. Nails and other sharp objects can tear fabrics.

#### **Proceed as follows:**

1. Use a screwdriver or similar tool.

2. Insert the screwdriver in the middle hole in the ridge and carefully push the screwdriver handle to the left.

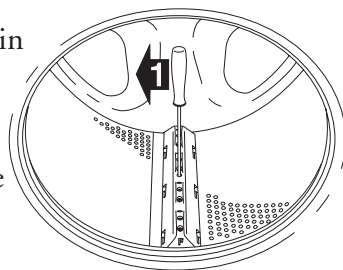

3. Grip the ridge with your other hand and pull it towards you as illustrated.

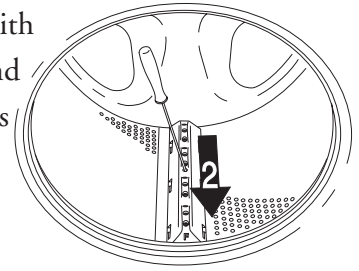

4. Lift up the ridge.

5. Remove any objects.

6. Position the ridge in the fixing holes with the F-mark facing you. Ensure that the ridge lugs fit firmly in their holes in the drum. Slide away from you until it stops.

### **HARD WATER**

If you live in an area with hard water, the washer drum may become coated with a grey-white deposit. To get rid of the deposit, pour a packet of citric acid, about 20 gram, in the drum and run the Normal wash program at 95°C. You will find citric acid on the spice shelf in your grocer's store.

# 11 TROUBLE SHOOTING

---

## MACHINE WILL NOT START

- Is the washer door properly closed?

Press it shut firmly.

- Check that the main power switch **ⓘ** is ON.

- Is the power supply interrupted?

Check the fuses in the house.

## WASHER DOOR WILL NOT CLOSE

If the door opens again immediately after you have closed it, check that you have made the correct program settings. If this does not help, there is probably a fault. Call the service department.

## WASHER DOOR WILL NOT OPEN

- Is the program complete?

Wait for the door mechanism to release at the end of the program.

- Check that the main power switch **ⓘ** is ON.

- Is the power supply interrupted?

Check the fuses in the house. The machine door cannot be opened with the [##] button if the power supply is interrupted.

- Is water still present in the machine?

Run either of the Drain or Spin programs at a suitable speed to remove the water.

- **Emergency opening**

If all else fails, emergency opening of the machine door is possible. Proceed as follows:

1. Check first that there is no water left in the machine. If there is, drain the machine as explained under the heading, Cleaning the needle trap and drain pump, in Chapter 10, Care and cleaning.

2. Make certain that the main power switch is OFF.

3. Open the drain pump cover, down to the left. Use the partition piece from the detergent compartment, as illustrated.

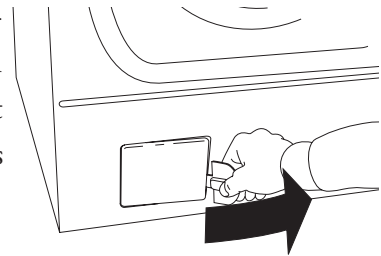

4. Unscrew the screw holding the red plastic handle in place.

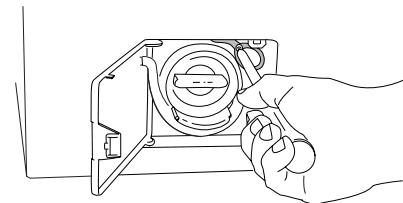

5. Pull the handle and the door will open.

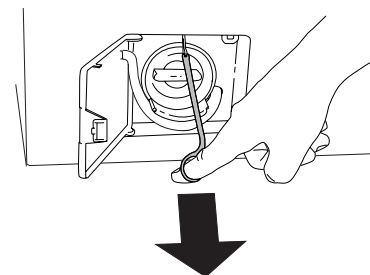

6. Put the handle into its slot and screw it into place. Close the drain pump cover.

If the door still cannot be opened in the normal way after this, phone for service.

### **MACHINE WILL NOT TAKE IN WATER AFTER STARTING**

- Check that the water tap is open.

Proceed as follows:

1. Open the water tap.
2. If the program started more than five minutes ago, restart the program with the  $\frac{\text{Start}}{\text{Stop}}$  button.

- Check that the strainer in the machine's water inlet is not clogged.

Proceed as follows:

1. Close the water tap.
2. Unscrew the hose to the machine's water inlet.
3. Clean the strainer in the machine's inlet valve.
4. Screw the hose back in place.
5. Open the water tap.
6. If the program started more than five minutes ago, restart the program with the  $\frac{\text{Start}}{\text{Stop}}$  button.

If this does not help, call the service department.

### **MACHINE WILL NOT SPIN**

- Check for any unbalance in the load.

The machine has an integral unbalance sensor, which causes the speed to be reduced or spinning to be bypassed if high unbalance is present in the load. The machine performs all the rinse sequences, however.

Proceed as follows:

1. Open the door and redistribute the load.
2. Run the Spin program at a suitable speed.

### **WATER REMAINS IN THE MACHINE AT THE END OF THE PROGRAM**

- Is the  button (No spin/No Drain) pressed in?

The machine has completed the program without spinning and does not pump out the water at the end of the program.

Switch off  and run either of the Drain or Spin programs at a suitable speed to remove the water.

- Is the power supply switched off?

If so, the machine will have stopped in the program. Check the fuses in the house. The program will continue when the power supply returns.

- Check the drain hose and the drain pump

Proceed as follows:

1. If necessary, straighten out any folds in the drain hose.
2. Has any object become trapped in the outlet from the drain hose? Clean the hose.
3. Is the drain pump blocked by a foreign body? Clean the pump; see Chapter 10, Care and cleaning.
4. Run either of the Drain or Spin programs at a suitable speed to remove the water.

### **PROGRAMS TAKE TOO LONG**

If a normal program takes over three hours, for example, the heating has probably failed to function. Start a new program. If the fault is repeated frequently, call the service department.

# 12 TECHNICAL INFORMATION

---

## TECHNICAL DATA

Height:	850 mm.
Width:	595 mm.
Depth:	585 mm.
Weight:	73 kg.
Drum volume:	50 litre.
Maximum washing capacity:	6.0 kg.
Spin speed, r/min:	800 or 1200 rpm.
Rated power, connection:	See data plate.
Rated power, element:	See data plate.
Water pressure:	0.1 - 1 MPa. 1 - 10 kp/cm <sup>2</sup> . 10 - 100 N/cm <sup>2</sup> .
Material: Washing drum and fluid container	Stainless steel.
Material: Outer cover	Powder-lacquered and hot-galvanized steel sheet or stainless steel.
Positioning:	Four adjustable, rubber-coated feet.
Water connection:	1.5 m PEX tube.
Drain:	1.7 polypropylene hose.

## STANDARD TESTS

Europe:	EN 60 456 (95/12/EEC).
Washing program:	Program 2 - Normal wash, 60°C, 5.0 kg cotton.
Connection:	Cold water 15°C.
Test procedure, acoustic measurement:	IEC 60 704-2-4.

# 13 SERVICE AND GUARANTEE

---

## SERVICE

Before calling for service, check to see whether the fault is due to something that you can put right yourself. See chapter 13, Trouble shooting.

If you do require service, telephone your local ASKO retailer or the ASKO representative for your country. See guarantee card for address and telephone number.

## GUARANTEE

For guarantee details, see the guarantee card.

### BEFORE CONTACTING THE SERVICE DEPARTMENT

Before contacting the Service Department, make a note of the model number, type designation and serial number.

The model number is on the detergent compartment. The type designation and the serial number are on the type plate located above the washer door.

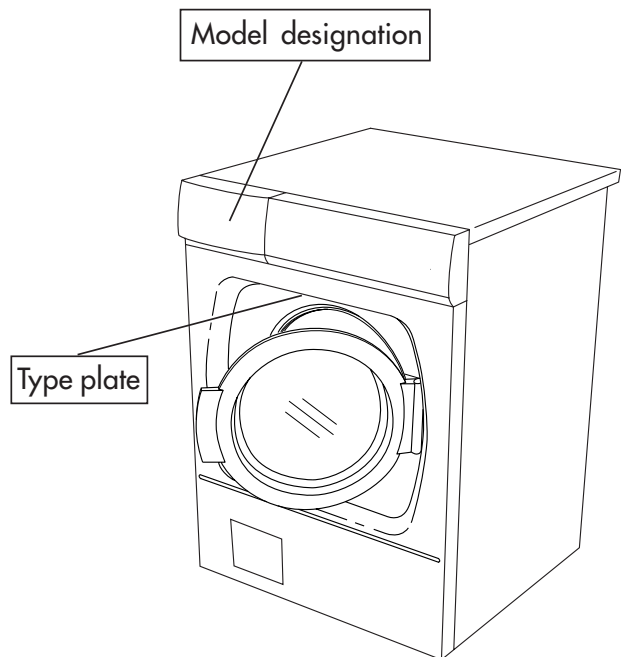
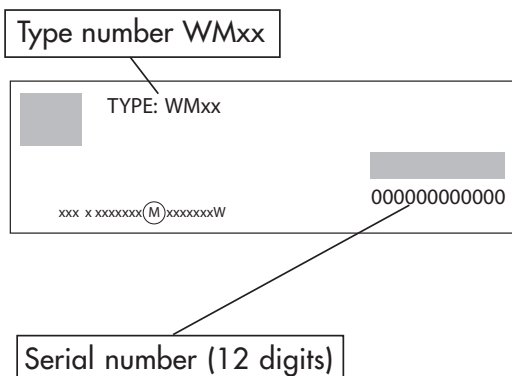

# 14 QUICK GUIDE

## 1. SORT THE WASHING.

## 2. PRESS THE MAIN POWER SWITCH, , AND OPEN THE DOOR, .

Load the washing.

## 3. FILL WITH DETERGENT AND CONDITIONER AS REQUIRED.

Detergent (main wash) to the left ( **2** ), detergent if required (pre-wash) in the middle section ( **1** ) and conditioner to the right (  ). If liquid detergent is used the partition piece, attached underneath the detergent compartment, is to be inserted in the inner slot of the compartment.

## 4. SELECT PROGRAM, SETTINGS AND OPTIONS

## 5. CLOSE THE DOOR.

## 6. START THE PROGRAM

Press the  button.

You can interrupt the program by holding down the  button for three seconds.

## 7. AFTER WASHING.

Turn the main switch, , OFF and close the door.

 <b>WASHING</b>	Items marked IWS, Superwash or Hand wash.	7-8	Wool/hand wash	30-40	800	1200	1/3
	Washing that only needs a quick freshener, eg, shirts, tracksuits.	6	Super quick wash	30-40	800/	1200	1/2
	Polyester, cotton/polyester, nylon. White garments.	4	Synthetic wash	60	800		1/2
	Slightly soiled cotton or linen.	5	Quick wash	40	800/	1200	1/2
	Cotton, linen. Darker coloured garments. Economy program.	2	Normal wash	40	800/	1200	1/1
	Cotton, linen. Darker coloured garments.	2	Normal wash	40-60	800/	1200	1/1
	Cotton, linen. Darker coloured garments.	2	Normal wash	40	800/	1200	1/1
	Cotton, linen. Darker coloured garments.	2	Normal wash	40	800/	1200	1/1
	Cotton, linen, white and light coloured garments. Super efficiency program.	2	Normal wash	60	800/	1200	1/1
	Cotton, linen, white and light coloured garments.	2	Normal wash	60-95	800/	1200	1/1
	Cotton, linen, white and light coloured garments.	1	Heavy wash	60-95	800/	1200	1/1
	Severely soiled washing, eg, working clothes.						

SET THE:

Program

Temperature (°C)

Spin speed

Amount of washing

# 15 INDEX

	Chapter		Chapter		Chapter
Acetate	7	Hand wash	7,8,14	Rinsing program	8
Acrylate	7	Hardness of water	1	Safety rules	2
Allergy	7,8	Hard water	10	Selecting program	8,14
Altering settings after starting	8	Heavy washing	8,14	Service	13
Amount of washing	7,14	Height	12	Short spin	7,8
<b>Bleach</b>	7	Installation, see Installation		Silk	7
Burling	7	instructions		Sorting the washing	7
		Interrupting a program	2	Spin drying	7,8,11,12,14
<b>Care</b>	10			Spin speed	8,12
Children's safety	3	Light wash	8,14	Start	8
Cleaning hole	10	Linen	7,14	Stop	8
Cleaning	10	Liquid detergent	8	Strainer	10
Colours	7	Main power switch	8,14	Super quick wash	8,14
Conditioner	5,8,14	Material	7,14	Super rinse	8
Consumption values	9	Needle trap	10	Synthetic fibre	7
Cotton	7,14	No drain	8	Synthetic fibre	7
Cover, drain pump	4,10,11	No spin	8	Synthetic wash	7,8,14
Crease free, see No drain		Normal wash	7,8,14	<b>Technical information</b>	12
		Nylon	7	Temperature	7,14
<b>Data plate</b>	4	<b>Odeur</b>	10	Textile dyeing	7
Delicate garments	7	Options	8	Time	9
Delicate washing	7	Overfill protection	2	Towelling	7
Depth	12	Packing material	2	Transport support	1
Detergent bag	8	Panel	6	Transport	2
Detergent ball	8	Partition piece	5,8	Trouble shooting	11
Detergent compartment	5,8	Parts of the washing machine	4	<b>Unbalance</b>	11
Detergent	7,8	Pockets	7	<b>Viscose</b>	7
Disposal	2	Polyester	7	<b>Washer door</b>	2,4,11
Door opening, see Washer door		Powder detergent	8	Washing capacity	8,12
Door, see Washer door		Power consumption	9	Washing ridge	10
Dosage	8	Pre-wash detergents	5,8,14	Washing	8,14
Drain hose	10	Pre-wash	8	Weight	12
Drain pump	10	Programs, see Wash programs		White washing	7,14
Drain	8	Quick guide	14	Width	12
Dyeing, see Textile dyeing		Quick wash	8,15	Winter storage	2
<b>Emergency stop, see Interrupt program</b>		<b>Rayon</b>	7	Wool washing	7,8,14
Error indications	11	Recommended washing marking	7	<b>Zip fasteners</b>	7
<b>Guarantee</b>	13				

