

This Owner's Manual is provided and hosted by [Appliance Factory Parts](#).



FANTECH FTC46931 Owner's Manual

[Shop genuine replacement parts for FANTECH
FTC46931](#)



[Find Your FANTECH Fan Parts - Select From 108 Models](#)

----- Manual continues below -----

Installation and Operational Manual

PRV Series

Power Roof Ventilators

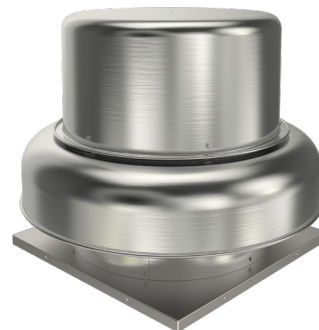

Fantech, Inc. and Systemair Mfg. certify that the ventilators shown herein are licensed to bear the AMCA Seal. The ratings shown are based on tests and procedures performed in accordance with AMCA Publication 211 and AMCA Publication 311 and comply with the requirements of the AMCA Certified Ratings Program.

Technical / Customer Support:

United States Tel.: 800.747.1762

Canada Tel.: 800.565.3548



fantech[®]
a systemair company

				
Note	Warning / Important note	Information	Technical information	Practical tip



Always disconnect, lock, and tag power source before installing or servicing. Failure to disconnect power source can result in fire, shock, or serious injury. Motor will restart without warning after thermal protector trips. Do not touch operating motor; it may be hot enough to cause injury.

Do not place any body parts or objects in fan, motor openings, or drives while motor is connected to power source.

Do NOT use this equipment in explosive atmospheres!

1. Read and follow all instructions and cautionary markings. Make sure electrical power source conforms to requirements of equipment.
2. Ventilators should be assembled, installed, and serviced by a qualified technician. Have all electrical work performed by a qualified electrician.
3. Follow all local electrical and safety codes in the United States and Canada - National Electrical Code (NEC), the Occupational Safety and Health Act (OSHA), and the National Fire Protection Association (NFPA) Bulletin 96 in the United States. Ground motor in accordance with NEC Article 250 (grounding). Follow the Canadian Electric Code (CEC) in Canada.

4. Motor and fan must be securely grounded (bare metal) to a suitable electric ground, such as a grounded water pipe or ground wire system.

In United States, to reduce the risk of injury to persons, OSHA complying guards are required when fan is installed within 8 feet of floor, ground, or working level.

In Canada, to reduce the risk of injury to persons, CSA complying guards are required when fan is installed below 2.5 meters (8.2 feet) above floor or grade level.

5. Do not kink power cable or allow it to come in contact with sharp objects, oil, grease, hot surfaces, or chemicals.
6. Never open access door to a duct with the ventilator running.
7. Do not operate direct drive fans with speed controller less than 50% of maximum fan speed.

Description

Power roof ventilators are designed, depending on model number, to either supply air to, or exhaust air from, commercial, institutional, and industrial buildings. Ventilators are available in a multitude of configurations including direct-drive or belt-drive units; roof, wall, or combination roof/wall mount and upblast or downblast discharge designs. Some units feature additional certifications required for use in kitchen ventilation systems.

Models 5DDU08 thru 5DDU18, 5DDW08 thru 5DDW18, 5BDD10 thru 5BDD49, 5BDU10 thru 5BDU36, 5ADE10 thru 5ADE24, 5ADS12 thru 5ADS24, 5DDD08 thru 5DDD18, 5FSU10 thru 5FSU20, 5ABE18 thru 5ABE36, and 5FSU10 thru 5FSU20 are UL Listed, Standard 705, & CSA Certified when sold complete with motor and drive. Upblast Centrifugal Roof Ventilators 5BDU10 thru 5BDU36, 5DDU10 thru 5DDU18, 5DDW10 thru 5DDW18 are UL Listed, Subject 762, when sold complete with motor and drive.

Storage

If fans are stored for any length of time, they should be stored in a clean, dry location to prevent rust and corrosion. Outdoor storage is not recommended. When outdoor storage is necessary, fans should be protected from the elements as completely as possible. Cover the fan inlet and outlet and keep motors dry and clean.

For extended storage (more than 3 months) motor shafts and bearings should be rotated monthly. If stored longer than 6 months, bearing grease in motor and fan should be purged and replaced with compatible grease. Belts should be rechecked for proper tension. Storage records should be kept to assure proper maintenance. The factory can advise warranty centers to provide motor and bearing service if needed.

INSTALLATION AND MAINTENANCE INFORMATION

Receiving, Inspection & Unpacking

When the equipment is received all items should be carefully checked against the bill of lading to be sure all crates and cartons have been received. Before accepting delivery, carefully inspect each carton or crate for visible shipping damage. If any damage is noticed, the carrier should make the proper notation on the delivery receipt acknowledging the damage. Make notations of all damage on all copies of the bill of lading and have all copies countersigned by the delivering carrier. The carrier should also fill out a Carrier Inspection Report. File claim for damage with the carrier. Physical damage to the unit after acceptance is not the responsibility of Fantech.

General Installation



CAUTION: Sheet metal parts, screws, clips and similar items inherently have sharp edges, and it is necessary that the installer and service personnel exercise caution.

The installation of this equipment shall be in accordance with the regulations of authorities having jurisdiction and all applicable codes.

This equipment is to be installed by an experienced installation company and fully trained personnel.

The mechanical installation of the exhaust ventilator consists of making final connections between the unit and building services, duct connections.

When motors and drive packs are shipped in separate cartons from the fan, check the carton labels to make sure the motor and drive pack you received are the correct combination for the fan being purchased. **Refer to the fan components list included in these instructions.**

Motor and Drive Pack Installation

Before mounting the motor to the fan motor/bearing support plate check the nameplate voltage of the motor to insure that it is compatible with the supply voltage. If the motor is a dual or tri voltage make sure the connections inside the motor are properly wired to match the supply voltage. Refer to the wiring schematic on the motor nameplate or inside the junction box. Record the motor that was installed and the voltage that the fan is wired for on the fan nameplate by checking the appropriate boxes.

Mount the motor to the fan in a slot pattern on the motor/bearing support plate that matches the motor frame footprint. The motor is mounted on the same side of the motor/bearing support plate as the bearings and fan shaft. The motor is usually mounted to the right side of the fan shaft. Use the hardware provided which is located in the motor compartment of the fan. Loosely snug the bolts at this time. Sizes 15, 16 and 18 have a spacer bolt pack included. The junction box on certain motors will hit the shaft. Use the spacers to raise the motor junction box above the shaft.

Install the adjustable sheave onto the motor shaft and the fixed sheave onto the fan shaft. Align the sheaves as shown on p.5 of these instructions and torque the set screws from 70 to 87 in-lbs. Install the V-belt around the sheaves and slide the motor in the slots provided to tension the belt (see p.4 for procedure). Once the belt is properly tensioned and the alignment is correct tighten down the motor mounting bolts. See p.11 for the wiring diagrams and motor location sketch.

Unpack each carton or crate and verify that all required parts and proper quantities of each item have been received. Refer to drawings for part descriptions. Report shortages or missing items to your local representative to arrange for replacement parts.

Due to availability of carriers and truck space, it is not possible to guarantee that all items will be shipped together. Verification of shipments must be limited to only those items on the bill of lading.

The unit nameplate must be checked to make sure the voltage agrees with the power supply available.

Electrical Connection



For Wiring diagrams please refer to p.9

1. Connect supply wiring to the disconnect switch (if supplied). Check the wiring diagrams on the motor for connections.
2. The motor is factory set at the voltage marked on the fan nameplate. Check the line voltage with the nameplate voltage and wiring diagrams.

3. The main power wiring should be sized for the amperage shown on the nameplate. Size wires in accordance with the ampacity tables in Article 310 of the National Electrical Code. If long wires are required, it may be necessary to increase wire size to prevent excessive voltage drop. Wires should be sized for a max of 3% voltage drop.

CAUTION: Use copper conductors only.

CAUTION: Protect wiring from sharp edges. Leave some slack in the line to prevent damage.

4. Disconnect switches (if supplied) are not fused. The power leads must be protected at the point of distribution in accordance with the fan nameplate.
5. On fans without a thermal protector integral to the motor (refer to unit or motor nameplate to determine if protector is present) a separate overload device is required. Refer to Sections 430-32 of the N.E.C. for sizing.
6. All units must be electrically grounded in accordance with local codes or, in the absence of local codes, with the latest edition of the National Electrical Code (ANSI/NFPA 70). A ground lug is provided as standard in the unit terminal box. Size grounding conductor in accordance with Table 250-95 of the National Electrical Code. **DO NOT** use the ground lug for connecting a neutral conductor.
7. Supply voltage to the power ventilator should not vary by more than 10% of the value indicated on the unit nameplate. Phase unbalance must not exceed 2%.

WARNING: Failure of motor due to operation on improper line voltage or with excessive phase unbalance constitutes product abuse and may cause severe damage to the unit's electrical components.

Roof Fan Installation

Downblast Fans (5BDD, 5DDD)

1. Position the fan with its wiring conduit in line with the wiring coming up through the roof curb and damper (if present). If the fan has an external disconnect switch, position the fan with the junction box towards the power supply.

Upblast Fans (5BDU, 5 DDU):

1. Position the fan with its wiring conduit, coming through the outer fan housing or its external disconnect, towards the power supply.
2. Run wires through the conduit to the switch. Leave some slack in the wire in the motor compartment so the motor and wheel assembly can be lifted for inspection and cleaning.

3. Bolt the fan base to the roof curb through the holes provided on the base using eight (8) lag bolts.
4. Make connection to the disconnect switch per above electrical instructions.
5. Restaurant fan installation must be in compliance with local codes and the National Fire Protection Association's NFPA-96.

Filter Supply Ventilators (5FSU):

1. The 5FSU10 & 5FSU12 are the only two sizes that we recommend can be wall mounted.
2. Use 5ACC28FS (8" roof curb) for the 5FSU10 fan.
3. Use 5ACC32FS (8" roof curb) for the 5FSU12 fan. Alternate methods by others.
4. Remove the wood nailer from the top of the roof curb.
5. Install a neoprene gasket on the roof curb where the wood nailer was located.
6. On the ground match drill the roof curb with the guide hole pattern in the cabinet bottom using a 5/16" drill bit.
7. Bolt either a 5FSU10 or 5FSU12 securely to the matching metal roof curb using 1/4" bolts and nuts.
8. Mount and bolt the roof curb and fan securely to a building sidewall using 1/4" anchor bolts.
9. Make sure the sidewall is sturdy enough to support the weight of the fan and roof curb.

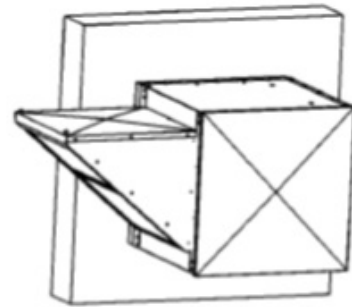

Figure. Recommended wall Installation



We recommend installing the Filtered Supply air Unit with the inlet assembly installed in a horizontal position, with the inlet assembly rotated 90°. This way, the filters point down, as opposed to at the wall.

Check, Test & Start Procedure



WARNING: Electric shock hazard. Could cause severe injury or death. Failure to bond the frame of this equipment to the building electrical ground by use of the grounding terminal provided or other acceptable means may result in electrical shock. Disconnect electric power before servicing equipment. Service to be performed only by qualified personnel.

BEFORE START-UP: Disconnect power to this unit before servicing the unit.

1. Check to verify that the wheel is free to rotate.
2. For optimum fan performance make sure that the wheel to inlet venturi overlap (0.25") is maintained.
3. Verify that supply voltage on the line side of disconnect agrees with voltage on fan nameplate and is within the 10% utilization voltage.
4. Apply power to unit and check rotation of wheel with the directional arrow on the unit.



WARNING: Rotation is critical. If allowed to operate in the wrong direction, the motor will overload and burn out. Wheel rotation is clockwise (CW) when viewed from the top or drive side of the fan. Especially check three-phase units for rotation. For three-phase, rotation can be changed by interchanging any two of the three line leads. If unit is checked on temporary wiring, it should be rechecked when permanently installed. Motor burn-out or tripped overload protection devices are usually the result of wrong rotation.

5. Electrical Input Check: Perform check of fan ampere draw and verify that motor nameplate amps are not exceeded. Take into account the service factor range if the motor is nameplated above a 1.0 service factor.
6. Fan RPM should be checked and verified with a tachometer.



NOTE: The fan should not need balancing, as it was balanced at the factory to be within stringent vibration levels before shipment. However, there are several things that may cause vibration, such as rough handling in shipment and installation, weak foundations and alignments.

V-Belts

V-belts on these belt driven fans are oil, heat, and static resistant type and oversized for continuous duty. With proper installation and maintenance, years of operating efficiency can be added to the lifespan of the V-belt drive. The condition of V-belts and the amount of belt tension should be checked prior to start-up (see Figure 1). When it becomes necessary to adjust belt tension, do not over-tension as bearing damage will occur. Recommended belt tension should permit 1/64 deflection per inch of span of the belt at the center of the belt span. To find this point, measure halfway between the pulley centerlines as shown in **Figure 2**. Extreme care must be exercised when adjusting V-belts as not to misalign the pulleys. Any misalignment will cause a sharp reduction in belt life and will also produce squeaky, annoying noises (see **Figure 3**). On units equipped with 2 groove pulleys, adjustments must be made so that there is equal tension on all belts (see **Figure 4**).

1. When tensioning loosen the motor mounting bolts and slide motor until proper tension is obtained.
2. Always loosen tension adjustment enough to place belts on sheaves without running

belts over the edge of either sheave. A new belt may be seriously damaged internally by careless handling (see **Figure 5**).



WARNING: When removing or installing belts, never force belts over pulleys without loosening motor first to relieve belt tension. The fan has been checked for mechanical noises at the factory prior to shipment. If mechanical noise should develop, then some suggestions are offered here as a guide toward remedying the cause.

1. Check rotating members for adequate clearance.
2. Check proper belt tension and pulley alignment.
3. Check installation and anchoring.
4. Check fan bearings.

Figure 1. Eliminate Slack



Figure 2. Belt Deflection

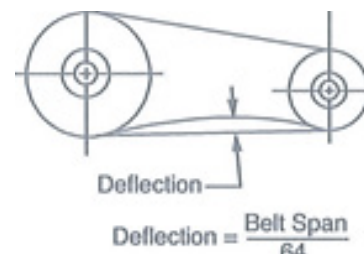

Slack belts wear excessively, cause slippage and deliver less power. For the longest belt life, always provide proper tension.

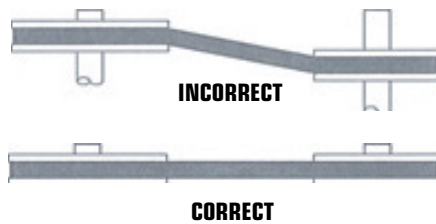
Figure 3. Alignment

Mount belts straight. Shafts must be parallel and sheaves in alignment to prevent belt wear.

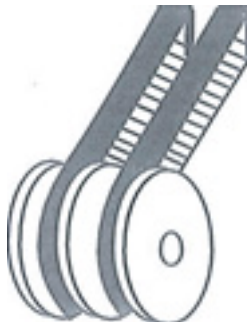
Figure 4. Two Groove Sheaves

Two groove adjustable sheaves must be opened the same number of turns on both sides.

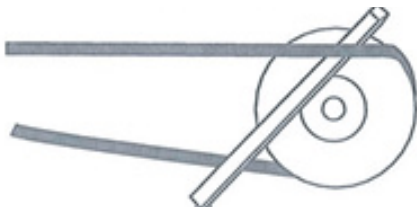
Figure 5. Belts

Do not force belt. Forcing the belt will break the cords and cause belt.

Maintenance

Installation and maintenance are to be performed only by qualified personnel who are familiar with local codes and regulations and experienced with this type of equipment.



CAUTION: Sharp edges and screws are a potential injury hazard. Avoid them.



WARNING: Hazardous moving parts. Unit may contain protected fan motor which may start automatically and cause injury. Allow time for reset. Disconnect power before servicing.

Preventive maintenance is the best way to avoid unnecessary expense and inconvenience. Start-up and routine maintenance should cover the following items:

- a. Tighten all setscrews, bolts and wire connections.
- b. Check belt tension and sheaves for wear.
- c. Lubricate fan bearings (see Tables 1 and 2).
- d. Cleaning of unit, wheel and damper (if present).



All motors containing ball bearings are permanently lubricated from the factory. No additional maintenance is required.

1. Before performing any maintenance on the fan, be sure power is turned off and locked in the OFF position at the service entrance.
2. Ventilators should be carefully checked at least once a year. For critical or rugged applications, a routine check every two or three months is suggested.
3. All motors supplied with Fantech ventilators carry a one-year limited warranty from date of shipment. For repairs within the warranty period, the motor must be taken to the motor manufacturer's authorized service dealer. Contact your representative for additional warranty details.
4. A periodic motor check should consist of spinning the motor shaft with the power off to be sure the motor turns freely and the bearings run smoothly. The belt on belt driven units should be removed from the motor sheave.
5. When removing or installing a belt, do not force the belt over the sheave. Loosen the motor mount so that the belt can be easily slipped over the sheave.
6. The belt on belt driven units should be removed and carefully checked for glazing, cracks, ply separation or irregular wear. A small irregularity in the contact surface of the belt will result in noisy operation. If any of these defects are apparent, the belt should be replaced. Check the sheaves also for chipping, dents or rough surfaces which could damage the belt.
7. The correct belt tension is important. Too tight of a belt will result in excess bearing pressure on the motor bearings and shaft pillow blocks and may also overload the motor. Too loose of a belt will result in slippage which will quickly "burn" out belts. A belt should feel "live" when thumped, approximately W belt deflection (3 to 5 lb.) when subject to finger pressure at midpoint between sheaves.

8. The belt alignment should also be checked to be sure the belt is running perpendicularly to the rotating shafts. Fan and motor shafts must be parallel. Improper alignment will result in excessive belt wear.
 9. Check sheave setscrews to ensure tightness. Proper keys must be in keyways.
 10. Do not readjust fan RPM. If sheaves are replaced, use only sheaves of identical size and type.
 11. If unit is to be left idle for an extended period, it is recommended that belts be removed and stored in a cool, dry place to avoid premature belt failure.
 12. The standard pillow block bearings on belt driven ventilators are factory lubricated and are provided with external grease fittings. Lubrication annually is recommended, or more frequently if needed (see Table 1). It is recommended to add fresh grease at start-up, but do not over-grease. Use only 1 or 2 shots of a recommended lubricant with a hand gun in most cases (see Table 2). Maximum hand gun rating 40 P.S.I. Rotate bearings during lubrication where good safety practice permits.
- CAUTION:** Greases of different soap bases (lithium, sodium, etc.) may not be compatible when mixed. Prevent such intermixing by completely purging the bearing of old greases. The most frequent causes of bearing failure are not greasing often enough, using an excessive quantity of grease, or using incompatible greases. Excessive vibration, especially if the bearing is not rotating, will also cause bearings to fail. Bearings must also be protected from water and moisture to avoid internal corrosion.
13. During the first few months of operation it is recommended that the bearing setscrews be checked periodically to ensure that they are tight.
 14. The rotating wheel requires particular attention since materials in the air being handled can build up on the blades to cause destructive vibration or weaken the structure of the wheel by corroding and/or eroding the blade metal. Regular inspection and corrective action at intervals determined by the severity of each application are essential to good service life and safety.

Intervals	Type of service
12 to 8	Infrequent operation or light duty in clean atmosphere
6 to 12	8 to 16 hrs./day in clean, relatively dry atmosphere
3 to 6	12 to 24 hrs./day, heavy duty, or if moisture is present
Monthly	Heavy duty in dirty, dusty locations; high ambient temperatures; moisture laden atmosphere; vibration; restaurant hood exhaust

Table 1. Suggested fan bearing greasing intervals in months

Manufacturer	Grease (NLGI #2)	Grease Temp Rating
Shell	Alvania RL2	176 °F
Chevron	SRI #2	350 °F
Exxon	Polyrex EM	350 °F

Table 2. Grease manufacturers



Proper bearing lubrication is required in order to keep the fan warranty active.

Fan Troubleshooting Chart

Problem	Possible causes
Fan does not operate	<ol style="list-style-type: none"> 1. Wrong voltage 2. Electricity turned off or not wired properly 3. Tripped overload protector 4. Blown fuses 5. Loose pulleys 6. Broken belts
Too little air	<ol style="list-style-type: none"> 1. Wheel rotating in wrong direction. 2. Fan speed lower than design. 3. System is more restrictive (more static pressure) than expected. 4. Restricted fan inlet or outlet. 5. Inlet or outlet screens clogged. 6. Filters (if applicable) are dirty or clogged.
Too much air	<ol style="list-style-type: none"> 1. Fan speed higher than design. 2. System is less restrictive (less static pressure) than expected.
Excessive horsepower	<ol style="list-style-type: none"> 1. Wheel rotating in wrong direction. 2. Wheel rubbing on inlet venturi. 3. Fan speed higher than design. 4. Worn fan bearings.
Excessive noise	<ol style="list-style-type: none"> 1. Wheel or sheaves loose. 2. Bearing or drive misalignment. 3. Accumulation of material on wheel. 4. Worn or corroded wheel. 5. Wheel out of balance. 6. Bent shaft 7. Bearings need lubrication 8. Loose bearing bolts. 9. Loose or worn bearings. 10. Mismatched belts. 11. Belts too loose or too tight. 12. Belts oily or dirty. 13. Belts worn. 14. Loose fan mounting bolts. 15. Rattle of loose components in high velocity airstream. 16. Electrical noise. 17. Noise from high velocity air system. 18. Vibrating parts not isolated from building. 19. Vibrating ductwork.
Excessive vibration	<ol style="list-style-type: none"> 1. Wheel or sheaves loose on shaft. 2. Wheel out of balance. 3. Excessive buildup of dirt/dust on wheel. 4. Belts too loose or too tight. 5. Mismatched belts. 6. Bent shaft. 7. Bearing or drive misalignment 8. Loose or worn bearings 9. Loose bolts 10. Weak mounting base for fan. 11. Curb not flat and level.

It is recommended that the users and installers of this shipment familiarize themselves with AMCA Publication #201, "Fans and Systems" and publication #202, "Troubleshooting" which are published by the Air Movement and Control Association (AMCA), 30 West University Drive, Arlington Heights, Illinois 60004. www.amca.org

Dimensions

Belt-Drive Downblast Roof Ventilators



Model	Wheel Diameter	Shaft Size	Dimensions					Shipping Weight	Recommended Roof Opening	Curb Size
			A	B	C	D	E			
5BDD 10	10 1/2	5/8	19	25 3/4	22 7/8	3	1 1/2	90	14 1/2 SQ.	17 1/2
5BDD 12	12 1/4	5/8	22	28	23 3/8	3	1 1/2	100	17 1/2 SQ.	20 1/2
5BDD 13	13 1/2	5/8	22	29 3/4	24 5/8	3 1/4	1 1/2	110	17 1/2 SQ.	20 1/2
5BDD 15	15	7/8	26	31 11/16	27 3/8	3 3/4	1 1/2	120	21 1/2 SQ.	24 1/2
5BDD 16	16 1/2	7/8	26	33 11/16	27 3/4	4 3/16	1 1/2	130	21 1/2 SQ.	24 1/2
5BDD 18	18 1/4	7/8	30	36	29 5/8	4 3/4	1 1/2	164	25 1/2 SQ.	28 1/2
5BDD 20	20	7/8	30	38 1/4	30 1/4	5 1/4	1 1/2	185	25 1/2 SQ.	28 1/2
5BDD 24	21 1/2	7/8	34	44 1/4	33	6 11/16	1 1/2	212	29 1/2 SQ.	32 1/2
5BDD 30	30	1 3/16	42	51 7/16	37 1/2	8 13/32	1 1/2	310	37 1/2 SQ.	40 1/2
5BDD 36	36 1/2	1 3/16	46	60	41 5/8	10 1/2	1 1/2	380	43 1/2 SQ.	44 1/2

Dimensional information is in inches.

Direct-Drive Downblast Roof Ventilators

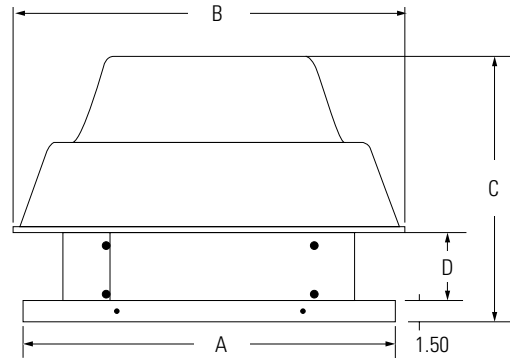

Model	Wheel Diameter	Shaft Size	Dimensions				Shipping Weight	Recommended Roof Opening	Curb Size
			A	B	C	D			
5DDD 085A	8	n/a	19	18 7/8	13 1/4	3 1/2	26	14 1/2 SQ.	17 1/2
5DDD 106A & 10AA	10 1/2	n/a	19	22 3/8	16 1/2	3 3/8	94	14 1/2 SQ.	17 1/2
5DDD 12CA	12 1/4	n/a	22	24 1/4	17 1/8	4	101	17 1/2 SQ.	20 1/2
5DDD 13DB	13 1/2	n/a	22	25 5/8	18 1/8	4 3/8	115	17 1/2 SQ.	20 1/2
5DDD 15CA	15	n/a	26	27 7/8	18 1/2	4 3/8	132	21 1/2 SQ.	24 1/2
5DDD 16DB	16 1/2	n/a	26	29 3/4	20 1/4	4 3/4	142	21 1/2 SQ.	24 1/2
5DDD 18EB	18 1/4	n/a	30	31 5/8	21 3/8	5 5/8	157	25 1/2 SQ.	28 1/2

Dimensional information is in inches.

Dimensions (cont.)

Belt-Drive Upblast Roof Ventilators



Model	Wheel Diameter	Shaft Size	Dimensions					Shipping Weight	Recommended Roof Opening	Curb Size
			A	B	C	D	E			
5BDU 10	10 1/2	5/8	19	23 7/8	23 3/8	16 7/8	1 1/2	90	14 1/2 SQ.	17 1/2
5BDU 12	12 1/4	5/8	22	26 1/2	24 1/4	17 3/4	1 1/2	100	17 1/2 SQ.	20 1/2
5BDU 13	13 1/2	5/8	22	27 7/8	24 5/8	18 1/2	1 1/2	105	17 1/2 SQ.	20 1/2
5BDU 15	15	7/8	26	29 7/8	27 3/8	19 3/8	1 1/2	120	21 1/2 SQ.	24 1/2
5BDU 16	16 1/2	7/8	26	31 3/4	27 3/4	20 1/8	1 1/2	125	21 1/2 SQ.	24 1/2
5BDU 18	18 1/4	7/8	30	34	29 7/8	21 1/8	1 1/2	171	25 1/2 SQ.	28 1/2
5BDU 20	20	7/8	30	36 1/2	30 1/4	22	1 1/2	173	25 1/2 SQ.	28 1/2
5BDU 24	21 1/2	7/8	34	42 3/8	33	24 1/2	1 1/2	205	29 1/2 SQ.	32 1/2
5BDU 30	30	1 3/16	42	49 1/2	38 3/4	27 1/2	1 1/2	305	37 1/2 SQ.	40 1/2
5BDU 36	36 1/2	1 3/16	46	58 1/6	42 7/8	31 1/2	1 1/2	385	43 1/2 SQ.	44 1/2

Dimensional information is in inches.

Direct-Drive Upblast Roof Ventilators

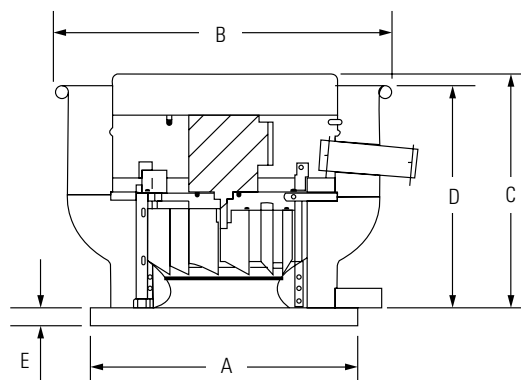

Model	Wheel Diameter	Shaft Size	Dimensions				Shipping Weight	Recommended Roof Opening	Curb Size
			A	B	C	D			
5DDU 085AY	8	n/a	19	20 1/2	12 1/8	10	23	14 1/2 SQ.	17 1/2
5DDU 106A & 10AA	10 1/2	n/a	19	23 7/8	18 7/8	16 7/8	88	14 1/2 SQ.	17 1/2
5DDU 12CA	12 1/4	n/a	22	26 1/8	19 5/8	17 3/4	109	17 1/2 SQ.	20 1/2
5DDU 13DB	13 1/2	n/a	22	27 7/8	20 3/4	18 1/2	117	17 1/2 SQ.	20 1/2
5DDU 15CA	15	n/a	26	29 7/8	22	19 3/8	130	21 1/2 SQ.	24 1/2
5DDU 16DB	16 1/2	n/a	26	31 3/4	22 3/4	20 1/8	144	21 1/2 SQ.	24 1/2
5DDU 18EB	18 1/4	n/a	30	34	24	21 1/8	159	25 1/2 SQ.	28 1/2

Dimensional information is in inches.

Wiring Diagrams

5BDU & 5BDD 10BB; 12BB; 12CB; 13BB; 13CB; 13DB; 15BB; 15CB; 15DB;
16CB; 16DB; 18CB; 18DB; 20CB; 20DB; 24CB; 24DB; 30DB; **5FSU** 10BB & 10CB

CAPACITOR START MOTOR

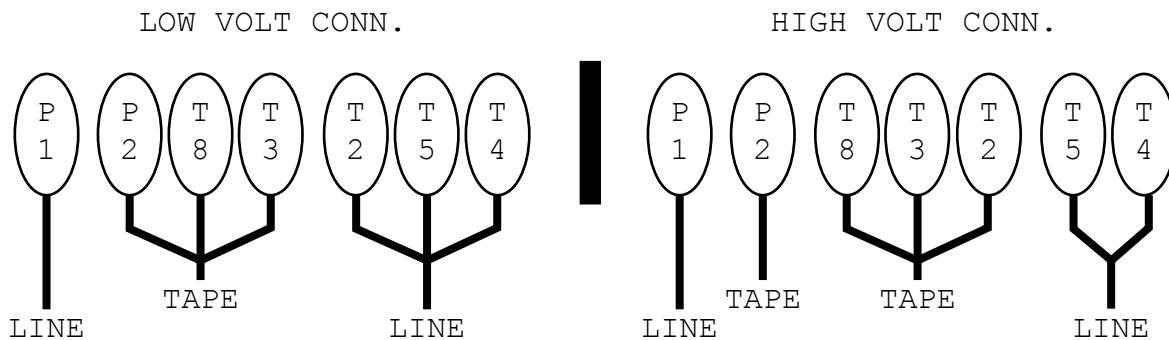

CCW ROTATION SWITCH END
TO REVERSE ROTATION INTER-
CHANGE LEADS T5 AND T8

5BDU & 5BDD 13DX; 15DX; 16DX; 16EX; 18DX; 18EX; 20DX; 20EX; 24DX; 24EX; 30DX; 30EX & 36EX

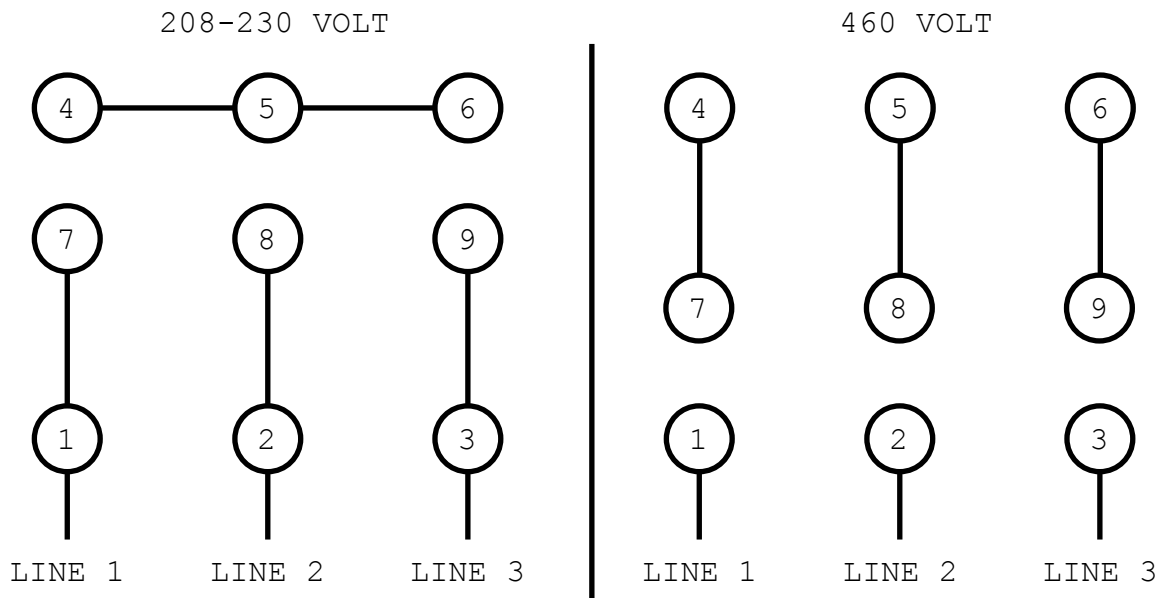

TO REVERSE ROTATION
INTERCHANGE ANY TWO LEADS

Wiring Diagrams (cont.)

5BDU & 5BDD 15EB; 15FB; 15EB; 16FB; 18EB; 18FB; 18GB; 20EB; 20FB; 20GB;
 24EB; 24FB; 24GB; 30EB; 30FB; 30GB; 36EB; 36FB; 36GB; **5FSU** 10FB; 12EB; 15FB; 15GB & 18GB

CONNECTIONS

UNGROUNDED
 SIDE OF LINE

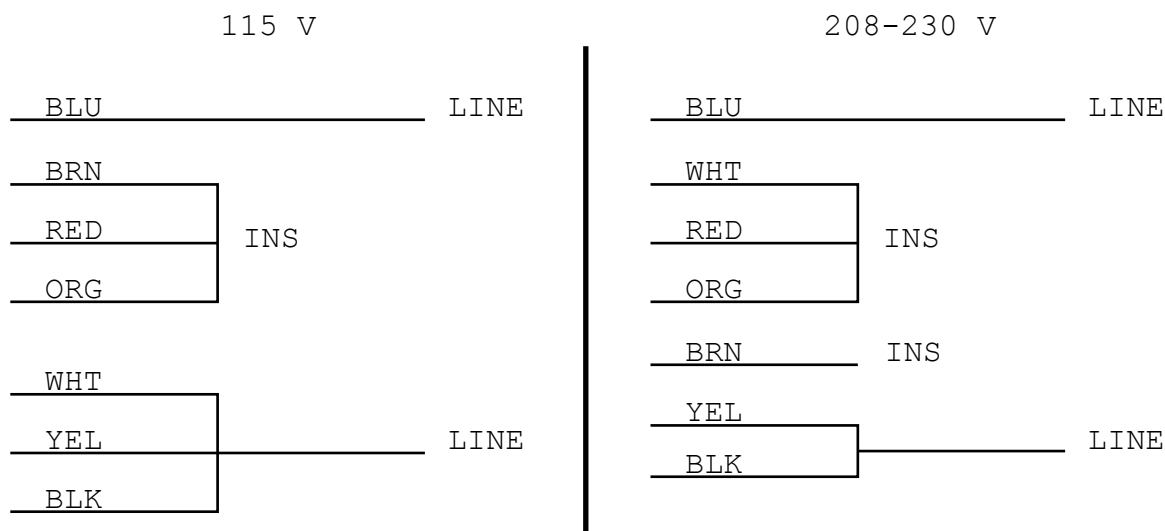

MOTOR IS CCW ROTATION LEAD END
 TO REVERSE INTERCHANGE
 RED AND BLACK LEADS

5BDU & 5BDD 15FX; 16FX; 18FX; 18GX; 18HX; 20FX; 20GX; 20HX; 24FX; 24GX; 24HX;
 30FX; 30GX; 30HX; 30JX; 30KX; 36FX; 36GX; 36HX; 36JX & 36KX

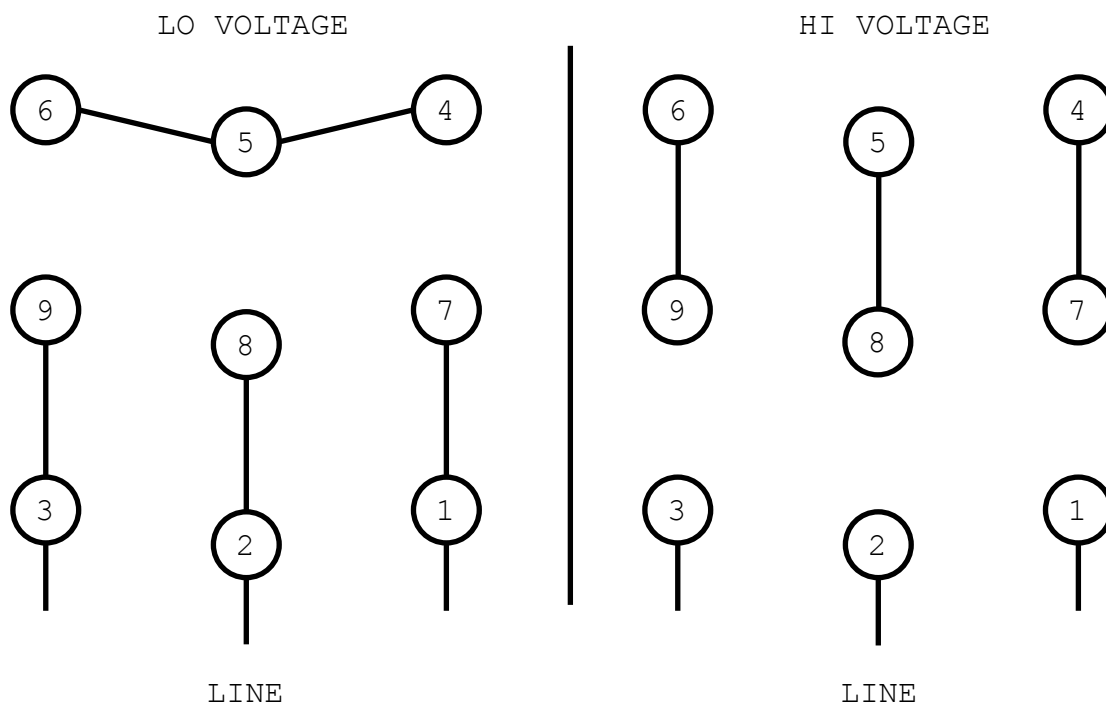

Wiring Diagrams (cont.)

5FSU 10DB



TO REVERSE ROTATION
INTERCHANGE RED & BLK LEADS

Motor Location Diagram



Incorrect motor location



Correct motor location

1. Mount motor in matching slot pattern provided.
2. Install belt with motor bolts finger tight & slide motor to the right until belt is tight.
3. Tighten motor mounting bolts.

Shell Belt Drive Fan Components List

Model	Shell		Roof curb				HP	1 Phase				3 Phase			
	Art. #	Weight, lbs	Max Opening Dimensions	Model	Art. #	Weight, lbs		Drive Pack		Motor		Drive Pack		Motor	
								Art. #	DP ID	Art. #	Motor ID	Art. #	DP ID	Item #	Motor ID
5BDU10	49800	90	19" x 19"	5ACC17FS /FT /VC	47206 / 47207 / 47208	24 / 29 / 38	1/4	48992	DP-10"-BB	49907	MOT BB				
5BDU12	49801	100	22" x 22"	5ACC20FS /FT /VC	47212 / 47213 / 47214	28 / 33 / 38	1/4	48993	DP-12"-BB	49907	MOT BB				
							1/3	48994	DP-12"-CB	49909	MOT CB				
5BDU13	49802	105	22" x 22"	5ACC20FS /FT /VC	47212 / 47213 / 47214	28 / 33 / 38	1/4	48995	DP-13"-BB	49907	MOT BB				
							1/3	48996	DP-13"-CB	49909	MOT CB				
							1/2	48997	DP-13"-DB	49910	MOT DB	49000	DP-13"-DX	49911	MOT DX
5BDU15	49803	120	26" x 26"	5ACC24FS /FT /VC	47217 / 47941 / 47219	33 / 38 / 47	1/4	49001	DP-15"-BB	49907	MOT BB				
							1/3	49002	DP-15"-CB	49909	MOT CB				
							1/2	49003	DP-15"-DB	49910	MOT DB	49004	DP-15"-DX	49911	MOT DX
							3/4	49005	DP-15"-EB/EX	49912	MOT EB	49005	DP-15"-EB/EX	49913	MOT EX
5BDU16	49804	125	26" x 26"	5ACC24FS /FT /VC	47217 / 47941 / 47219	33 / 38 / 47	1	49007	DP-15"-FB/FX	49914	MOT FB	49007	DP-15"-FB/FX	49915	MOT FX
							1/3	49010	DP-16"-CB	49909	MOT CB				
							1/2	49011	DP-16"-DB	49910	MOT DB	49012	DP-16"-DX	49911	MOT DX
							3/4	49013	DP-16"-EB/EX	49912	MOT EB	49013	DP-16"-EB/EX	49913	MOT EX
5BDU18	49805	171	30" x 30"	5ACC28FS /FT /VC	47221 / 47222 / 47223	40 / 48 / 54	1	49015	DP-16"-FB/FX	49914	MOT FB	49015	DP-16"-FB/FX	49915	MOT FX
							1/3	49017	DP-18"-CB	49909	MOT CB				
							1/2	49018	DP-18"-DB	49910	MOT DB	49019	DP-18"-DX	49911	MOT DX
							3/4	49020	DP-18"-EB/EX	49912	MOT EB	49020	DP-18"-EB/EX	49913	MOT EX
5BDU20	49806	173	30" x 30"	5ACC28FS /FT /VC	47221 / 47222 / 47223	40 / 48 / 54	1	49022	DP-18"-FB/FX	49914	MOT FB	49022	DP-18"-FB/FX	49915	MOT FX
							1-1/2	49024	DP-18"-GB	49916	MOT GB	49024	DP-18"-GB	49917	MOT GX
							2					49026	DP-18"-HX	49918	MOT HX
							1/3	49027	DP-20"-CB	49909	MOT CB				
5BDU24	49807	205	34" x 34"	5ACC32FS /FT /VC	47226 / 47227 / 47228	46 / 53 / 52	1/2	49028	DP-20"-DB	49910	MOT DB	49029	DP-20"-DX	49911	MOT DX
							3/4	49031	DP-20"-EB/EX	49912	MOT EB	49031	DP-20"-EB/EX	49913	MOT EX
							1	49032	DP-20"-FB/FX	49914	MOT FB	49032	DP-20"-FB/FX	49915	MOT FX
							1-1/2	49036	DP-20"-GB/GX	49916	MOT GB	49036	DP-20"-GB/GX	49917	MOT GX
5BDU30	49808	305	42" x 42"	5ACC40FS /FT /VC	47233 / 47901 / 47234	57 / 68 / 63	2					49038	DP-20"-HX	49918	MOT HX
							1/3	49039	DP-24"-CB	49909	MOT CB				
							1/2	49040	DP-24"-DB	49910	MOT DB	49041	DP-24"-DX	49911	MOT DX
							3/4	49042	DP-24"-EB/EX	49912	MOT EB	49042	DP-24"-EB/EX	49913	MOT EX
5BDU36	49809	385	46" x 46"	5ACC44FS /FT /VC	47237 / 47238 / 47665	68 / 73 / 92	1	49044	DP-24"-FB/FX	49914	MOT FB	49044	DP-24"-FB/FX	49915	MOT FX
							1-1/2	49046	DP-24"-GB/GX	49916	MOT GB	49046	DP-24"-GB/GX	49917	MOT GX
							2					49051	DP-24"-HX	49918	MOT HX
							3					49052	DP-30"-DX	49911	MOT DX
5BDU36	49809	385	46" x 46"	5ACC44FS /FT /VC	47237 / 47238 / 47665	68 / 73 / 92	1/2	49466	DP-30"-DB	49910	MOT DB	49052	DP-30"-DX	49911	MOT DX
							3/4	49053	DP-30"-EB/EX	49912	MOT EB	49053	DP-30"-EB/EX	49913	MOT EX
							1	49055	DP-30"-FB/FX	49914	MOT FB	49055	DP-30"-FB/FX	49915	MOT FX
							1-1/2	49057	DP-30"-GB/GX	49916	MOT GB	49057	DP-30"-GB/GX	49917	MOT GX
5BDU36	49809	385	46" x 46"	5ACC44FS /FT /VC	47237 / 47238 / 47665	68 / 73 / 92	2					49060	DP-30"-HX	49918	MOT HX
							3					49061	DP-30"-JX	49919	MOT JX
							5					49062	DP-30"-KX	49920	MOT KX
							3/4	49063	DP-36"-EB/EX	49912	MOT EB	49063	DP-36"-EB/EX	49913	MOT EX
5BDU36	49809	385	46" x 46"	5ACC44FS /FT /VC	47237 / 47238 / 47665	68 / 73 / 92	1	49065	DP-36"-FB/FX	49914	MOT FB	49065	DP-36"-FB/FX	49915	MOT FX
							1-1/2	49067	DP-36"-GB/GX	49916	MOT GB	49067	DP-36"-GB/GX	49917	MOT GX
							2					49069	DP-36"-HX	49918	MOT HX
							3					49070	DP-36"-JX	49919	MOT JX
5BDU36	49809	385	46" x 46"	5ACC44FS /FT /VC	47237 / 47238 / 47665	68 / 73 / 92	5					49072	DP-36"-KX	49920	MOT KX

Shell Belt Drive Fan Components List (cont.)

Model	Shell		Roof curb				HP	1 Phase				3 Phase			
	Art. #	Weight, lbs	Max Opening Dimensions	Model	Art. #	Weight, lbs		Drive Pack		Motor		Drive Pack		Motor	
								Art. #	DP ID	Art. #	Motor ID	Art. #	DP ID	Item #	Motor ID
5BDD10	49810	90	19" x 19"	5ACC17FS /FT /VC	47206 / 47207 / 47208	24 / 29 / 38	1/4	48992	DP-10"-BB	49907	MOT BB				
5BDD12	49811	100	22" x 22"	5ACC20FS /FT /VC	47212 / 47213 / 47214	28 / 33 / 38	1/4	48993	DP-12"-BB	49907	MOT BB				
							1/3	48994	DP-12"-CB	49909	MOT CB				
5BDD13	49812	110	22" x 22"	5ACC20FS /FT /VC	47212 / 47213 / 47214	28 / 33 / 38	1/4	48995	DP-13"-BB	49907	MOT BB				
							1/3	48996	DP-13"-CB	49909	MOT CB				
							1/2	48997	DP-13"-DB	49910	MOT DB	49000	DP-13"-DX	49911	MOT DX
5BDD15	49813	120	26" x 26"	5ACC24FS /FT /VC	47217 / 47941 / 47219	33 / 38 / 47	1/4	49001	DP-15"-BB	49907	MOT BB				
							1/3	49002	DP-15"-CB	49909	MOT CB				
							1/2	49003	DP-15"-DB	49910	MOT DB	49004	DP-15"-DX	49911	MOT DX
							3/4	49005	DP-15"-EB/EX	49912	MOT EB	49005	DP-15"-EB/EX	49913	MOT EX
5BDD16	49814	130	26" x 26"	5ACC24FS /FT /VC	47217 / 47941 / 47219	33 / 38 / 47	1	49007	DP-15"-FB/FX	49914	MOT FB	49007	DP-15"-FB/FX	49915	MOT FX
							1/3	49010	DP-16"-CB	49909	MOT CB				
							1/2	49011	DP-16"-DB	49910	MOT DB	49012	DP-16"-DX	49911	MOT DX
5BDD18	49815	164	30" x 30"	5ACC28FS /FT /VC	47221 / 47222 / 47223	40 / 48 / 54	3/4	49013	DP-16"-EB/EX	49912	MOT EB	49013	DP-16"-EB/EX	49913	MOT EX
							1	49015	DP-16"-FB/FX	49914	MOT FB	49015	DP-16"-FB/FX	49915	MOT FX
							1-1/2	49017	DP-18"-CB	49909	MOT CB				
							2	49018	DP-18"-DB	49910	MOT DB	49019	DP-18"-DX	49911	MOT DX
5BDD20	49816	185	30" x 30"	5ACC28FS /FT /VC	47221 / 47222 / 47223	40 / 48 / 54	3/4	49020	DP-18"-EB/EX	49912	MOT EB	49020	DP-18"-EB/EX	49913	MOT EX
							1	49022	DP-18"-FB/FX	49914	MOT FB	49022	DP-18"-FB/FX	49915	MOT FX
							1-1/2	49024	DP-18"-GB	49916	MOT GB	49024	DP-18"-GB	49917	MOT GX
							2					49026	DP-18"-HX	49918	MOT HX
							1/3	49027	DP-20"-CB	49909	MOT CB				
5BDD24	49817	212	34" x 34"	5ACC32FS /FT /VC	47226 / 47227 / 47228	46 / 53 / 52	1/2	49028	DP-20"-DB	49910	MOT DB	49029	DP-20"-DX	49911	MOT DX
							3/4	49031	DP-20"-EB/EX	49912	MOT EB	49031	DP-20"-EB/EX	49913	MOT EX
							1	49032	DP-20"-FB/FX	49914	MOT FB	49032	DP-20"-FB/FX	49915	MOT FX
							1-1/2	49036	DP-20"-GB/GX	49916	MOT GB	49036	DP-20"-GB/GX	49917	MOT GX
							2					49038	DP-20"-HX	49918	MOT HX
5BDD30	49818	310	42" x 42"	5ACC40FS /FT /VC	47233 / 47901 / 47234	57 / 68 / 63	1/3	49039	DP-24"-CB	49909	MOT CB				
							1/2	49040	DP-24"-DB	49910	MOT DB	49041	DP-24"-DX	49911	MOT DX
							3/4	49042	DP-24"-EB/EX	49912	MOT EB	49042	DP-24"-EB/EX	49913	MOT EX
							1	49044	DP-24"-FB/FX	49914	MOT FB	49044	DP-24"-FB/FX	49915	MOT FX
							1-1/2	49046	DP-24"-GB/GX	49916	MOT GB	49046	DP-24"-GB/GX	49917	MOT GX
5BDD36	49818	310	42" x 42"	5ACC40FS /FT /VC	47233 / 47901 / 47234	57 / 68 / 63	2					49051	DP-24"-HX	49918	MOT HX
							3					49052	DP-30"-DX	49911	MOT DX
							5					49053	DP-30"-EB/EX	49913	MOT EX
							1	49055	DP-30"-FB/FX	49914	MOT FB	49055	DP-30"-FB/FX	49915	MOT FX
							1-1/2	49057	DP-30"-GB/GX	49916	MOT GB	49057	DP-30"-GB/GX	49917	MOT GX
							2					49060	DP-30"-HX	49918	MOT HX
5BDU36	49809	385	46" x 46"	5ACC44FS /FT /VC	47237 / 47238 / 47665	68 / 73 / 92	3					49061	DP-30"-JX	49919	MOT JX
							5					49062	DP-30"-KX	49920	MOT KX
							3/4	49063	DP-36"-EB/EX	49912	MOT EB	49063	DP-36"-EB/EX	49913	MOT EX
							1	49065	DP-36"-FB/FX	49914	MOT FB	49065	DP-36"-FB/FX	49915	MOT FX
							1-1/2	49067	DP-36"-GB/GX	49916	MOT GB	49067	DP-36"-GB/GX	49917	MOT GX
5BDU36	49809	385	46" x 46"	5ACC44FS /FT /VC	47237 / 47238 / 47665	68 / 73 / 92	2					49069	DP-36"-HX	49918	MOT HX
							3					49070	DP-36"-JX	49919	MOT JX
							5					49072	DP-36"-KX	49920	MOT KX

Warranty

Fantech, Inc. warrants to the original purchaser that our products will be free from defects in material and workmanship for a period of one (1) year from the date of shipment. THIS IS OUR SOLE AND EXCLUSIVE PRODUCT WARRANTY AND IS IN LIEU OF AND EXCLUDES ALL OTHER WARRANTIES, EXPRESS OR IMPLIED, ARISING BY OPERATION OF LAW OR OTHERWISE, INCLUDING WITHOUT LIMITATION, MERCHANTABILITY AND FITNESS FOR A PARTICULAR PURPOSE WHETHER OR NOT THE PURPOSE OR USE HAS BEEN DISCLOSED TO US IN SPECIFICATIONS, DRAWINGS OR OTHERWISE, AND WHETHER OR NOT OUR PRODUCTS ARE SPECIFICALLY DESIGNED AND/OR MANUFACTURED BY US FOR PURCHASER'S USE OR PURPOSE.

This warranty does not cover any losses or damages due to misuse, accident, abuse, neglect, normal wear and tear, negligence (other than ours), unauthorized alteration, use beyond rated capacity, or improper installation, maintenance or application. This warranty shall be null and void to the extent that purchaser supplied incorrect information to us about the necessary product specifications or the environment in which the products were to be used, and our selection or design of the products for the purchaser was based in part on such information.

Limitation of Warranty and Liability

THE SOLE AND EXCLUSIVE REMEDY FOR BREACH OF ANY WARRANTY HEREUNDER SHALL BE LIMITED TO REPAIR, CORRECTION OR REPLACEMENT, OR REFUND OF THE PURCHASE PRICE UNDER THE PRECEDING PARAGRAPH ENTITLED "LIMITED WARRANTY". FANTECH VENTILATION PRODUCTS SHALL NOT BE LIABLE FOR DAMAGES CAUSED BY DELAY IN PERFORMANCE AND IN NO EVENT, REGARDLESS OF THE FORM OF THE CLAIM OR CAUSE OF ACTION, SHALL OUR LIABILITY TO PURCHASER AND/OR ITS CUSTOMERS EXCEED THE PRICE PAID BY PURCHASER FOR THE SPECIFIC PRODUCT PROVIDED BY US THAT GAUE RISE TO THE CLAIM OR CAUSE OF

If within thirty (30) days after purchaser's discovery of any warranty defects within the warranty period, purchaser notifies us thereof in writing, we shall, at our option, repair, correct or replace F.O.B. point of manufacture, or refund the purchase price for, the products that we have found to be defective. Failure by purchaser to give such written notice within the 30-day time period shall be deemed an absolute and unconditional waiver of purchaser's claim for such defects. Products repaired or replaced shall be covered by this warranty for the remainder of the original warranty period or ninety (90) days from the date of shipment, whichever is longer.

Warranty claims should be sent to Fantech, Inc., Attn: Quality Department, 10048 Industrial Blvd., Lenexa, KS 66215. Included in the claim should be Order Number, Model Numbers, Serial Numbers and a detailed description of the issues.

Purchaser assumes all other responsibility for any loss, damage or injury to persons or property arising out of the use of our products, either alone or in combination with other products or components.

ACTION. PURCHASER AGREES THAT IN NO EVENT SHALL OUR LIABILITY TO PURCHASER AND/OR ITS CUSTOMERS EXTEND TO INCLUDE INCIDENTAL, CONSEQUENTIAL OR PUNITIVE DAMAGES. The term "consequential damages" shall include, but not be limited to, loss of anticipated profits, business interruption, loss of use or revenue, cost of capital, or loss or damage to property or equipment. It is expressly understood that any technical advice furnished by us with respect to the use of our products is given without charge, and we assume no obligation or liability for the advice given, or results obtained, all such advice being given and accepted.

Warning

Fantech products are designed and manufactured to provide reliable performance, but they are not guaranteed to be 100% free from defects. Even reliable products will experience occasional failures and this possibility should be recognized by the user. If these products are

used in a life support ventilation system where failure could result in loss or injury, the user should provide adequate backup ventilation, supplementary natural ventilation, failure alarm system, or acknowledge willingness to accept the risk of such loss or injury.

For Customer/Technical Support call (800) 747-1762

Fantech reserves the right to make technical changes.
For updated documentation please refer to www.fantech.net

Fantech®