

FARBERWARE® MILLENNIUM®

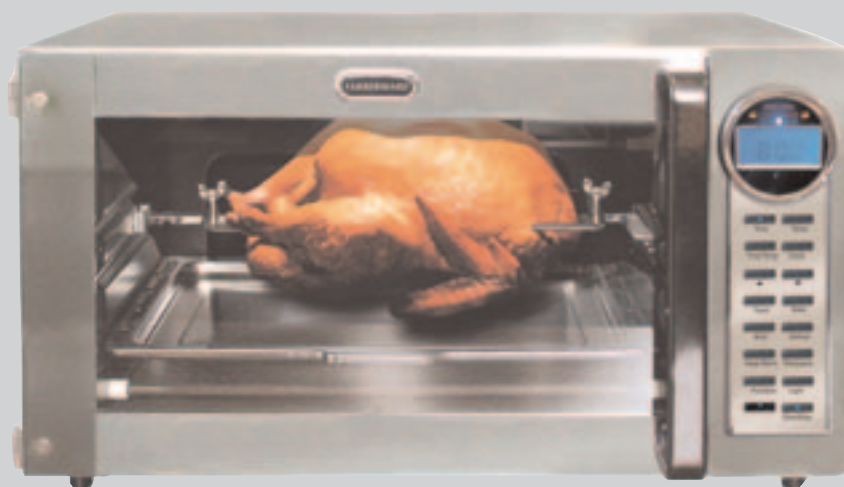

USE & CARE INSTRUCTIONS CONVECTION OVEN WITH ROTISSERIE

FAC900R

IMPORTANT SAFEGUARDS

When using electrical appliances, basic safety precautions should always be followed including the following:

1. Read all instructions.
2. Do not touch hot surfaces. Use handles or knobs.
3. To protect against electrical shock do not immerse cord, plugs, or appliance in water or other liquid.
4. Close supervision is necessary when any appliance is used by or near children.
5. Unplug from outlet when not in use and before cleaning. Allow to cool before putting on or taking off parts.
6. Do not operate any appliance with a damaged cord or plug or after the appliance malfunctions, or has been damaged in any manner. Contact Consumer Service for examination, repair or adjustment.
7. The use of accessory attachments not recommended by the appliance manufacturer may cause injuries.
8. Do not use outdoors.
9. Do not let cord hang over edge of table or counter, or touch hot surfaces.
10. Do not place on or near a hot gas or electric burner, or in a heated Oven.
11. Extreme caution must be used when moving an appliance containing hot oil or other liquids.
12. To disconnect, press the START/STOP Button so that the ON/OFF Light is off, then remove plug from wall outlet.
13. Do not use appliance for other than intended use.
14. Oversize foods or metal utensils must not be inserted in a Toaster-Oven as they may create a fire or risk of electric shock.
15. A fire may occur if the Toaster Oven is covered or touching flammable material, including curtains, draperies, walls, and the like, when in operation. Do not store any item on top of the appliance when in operation.
16. Do not clean with metal scouring pads. Pieces can break off the pad and touch electrical parts involving a risk of electrical shock.
17. Extreme caution should be exercised when using containers constructed of other than metal or glass.
18. Do not store any materials, other than manufacturers recommended accessories, in this Oven when not in use.

IMPORTANT SAFEGUARDS *(CONTINUED)*

19. Do not place any of the following materials in the Oven: paper, cardboard, plastic, and the like.
20. Do not cover crumb tray or any part of the Oven with metal foil. This will cause overheating of the Oven.
21. Use extreme caution when removing tray or disposing of hot grease.

SAVE THESE INSTRUCTIONS

THIS PRODUCT IS FOR HOUSEHOLD USE ONLY

ADDITIONAL IMPORTANT SAFEGUARDS

CAUTION HOT SURFACES: This appliance generates heat and escaping steam during use. Proper precautions must be taken to prevent the risk of burns, fires, or other injury to persons or damage to property.

1. A person who has not read and understood all operating and safety instructions is not qualified to operate this appliance. All users of this appliance must read and understand the Use and Care Instructions before operating or cleaning this appliance.
2. If this appliance falls or accidentally becomes immersed in water, unplug it from the wall outlet immediately. **Do not reach into the water!**
3. When using this appliance, provide adequate air space above and on all sides for air circulation. Do not operate this appliance while it is touching or near curtains, wall coverings, clothing, dishtowels or other flammable materials.
4. To reduce the risk of fire, do not leave this appliance unattended during use.
5. If this appliance begins to malfunction during use, immediately press the START/STOP Button and unplug the cord. Do not use or attempt to repair a malfunctioning appliance!
6. The cord to this appliance should only be plugged into a 120V AC electrical wall outlet.
7. Do not use this appliance in an unstable position.
8. To reduce the risk of burns or other injuries, do not touch hot surfaces. Use of protective oven mitts or gloves as well as long handled utensils is recommended. Use the Rotisserie Bar Remover when removing Rotisserie Bar Assembly from inside the Rotisserie.
9. To reduce the risk of injury to persons or property, unplug this appliance before inserting food. Always keep the appliance unplugged from the wall outlet when not in use.
10. Do not attempt to dislodge food or clean the Rotisserie while it is plugged in or while it is still hot.

POLARIZED PLUG

This appliance has a polarized plug (one blade is wider than the other). To reduce the risk of electric shock, this plug is intended to fit into a polarized outlet only one way. If the plug does not fit fully in the outlet, reverse the plug. If it still does not fit, contact a qualified electrician. Do not attempt to modify the plug in any way.

SHORT CORD INSTRUCTIONS

A short power-supply cord is provided to reduce the risk resulting from becoming entangled in or tripping over a longer cord.

Do not use an extension cord with this product.

ELECTRIC POWER

If the electrical circuit is overloaded with other appliances, your appliance may not operate properly. It should be operated on a separate electrical circuit from other appliances.

PLASTICIZER WARNING

CAUTION: To prevent Plasticizers from migrating from the finish of the counter top or table top or other furniture, place **NON-PLASTIC** coasters or place mats between the appliance and the finish of the counter top or table top.

Failure to do so may cause the finish to darken. Permanent blemishes may occur or stains can appear.

INTRODUCTION

A convection oven circulates heated air continuously throughout the Oven cavity to maintain uniform temperature around the food. This constant, gentle air flow is what seals in juices, promotes browning and may shorten cooking time without turning and basting. Your FARBERWARE® Convection Oven can TOAST, BAKE, SLOW COOK, ROAST, BROIL, ROTISSERIE, DEFROST, KEEP WARM and DEHYDRATE. The Oven has a special recessed area to accommodate a 12" pizza.

GETTING TO KNOW YOUR **FARBERWARE®** CONVECTION OVEN WITH ROTISSERIE

PRODUCT MAY VARY SLIGHTLY FROM ILLUSTRATIONS

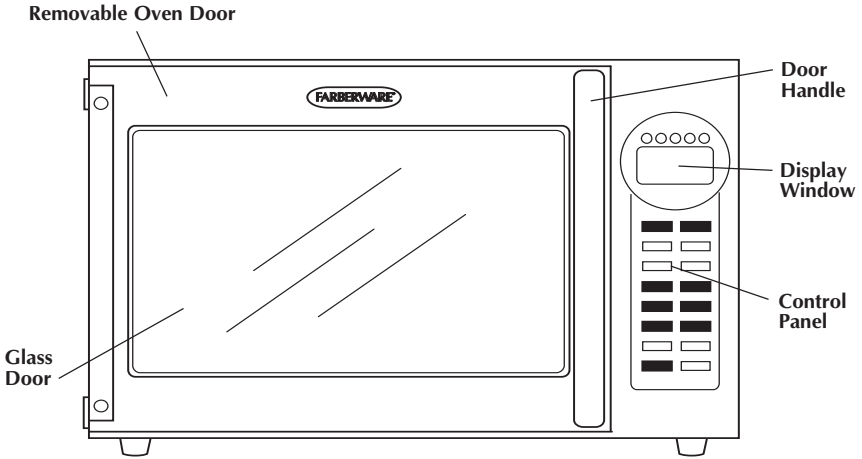

Figure 1

CONVECTION OVEN ACCESSORIES

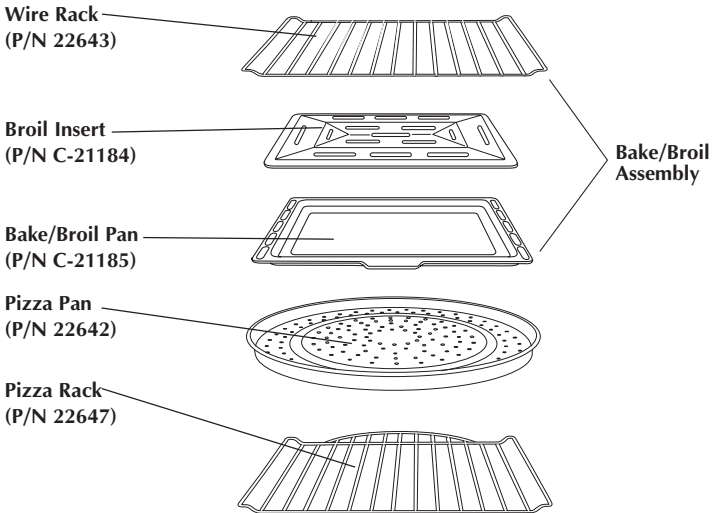
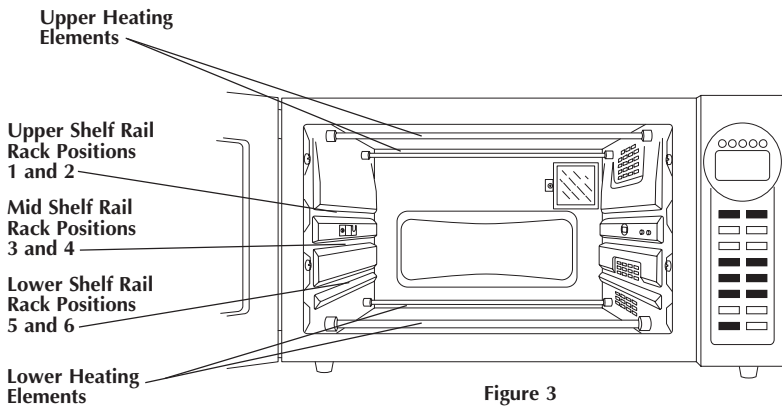

Figure 2

CONVECTION OVEN SHELF RAILS AND RACK POSITIONS



WIRE RACKS AND RACK POSITIONS

Wire Rack
(Rack Positions 1, 3, 5)

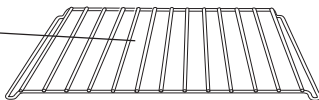

Wire Rack Inverted
(Rack Positions 2, 4, 6)



Pizza Rack
(Rack Positions 3, 4)

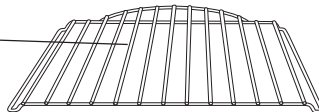

Pizza Rack Inverted
(Rack Positions 5, 6)

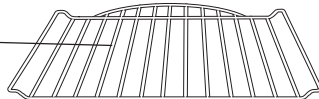

Figure 4

CONTROL PANEL

The Oven has 6 different preset Functions/Buttons: TOAST, BAKE, BROIL, DEFROST, KEEP WARM and ROTISSERIE.

The Convection Fan is ON in all Functions except TOAST.

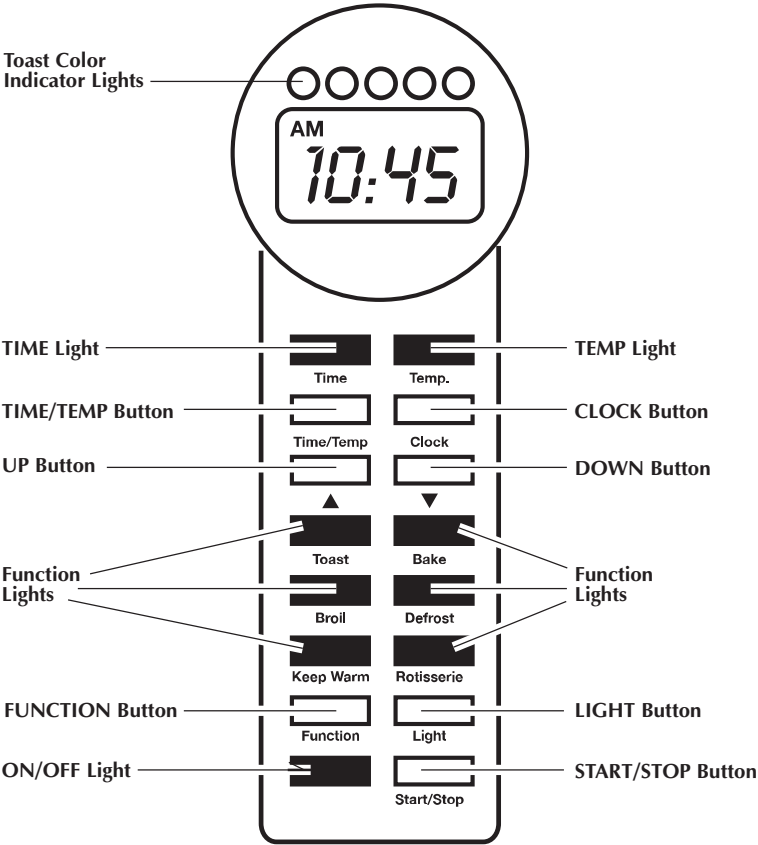

Figure 5

DISPLAY WINDOW

Indicates time of day, Function, and amount of time left for completion of Function. When the TIME/TEMP Button is pressed, the preset Temperature is shown. As changes are made, they will be displayed in the Window.

TOAST

Press FUNCTION Button to select the TOAST function. When the selection is made, the TOAST Light will illuminate and the Oven will default to the center Toast Color Indicator Light for medium browning.

BAKE

Press FUNCTION Button to select the BAKE function. When the selection is made, the BAKE Light will illuminate.

BROIL

Press FUNCTION Button to select the BROIL function. When the selection is made, the BROIL Light will illuminate.

DEFROST

Press FUNCTION Button to select the DEFROST function. When the selection is made, the DEFROST Light will illuminate.

KEEP WARM

Press FUNCTION Button to select the KEEP WARM function. When the selection is made, the KEEP WARM Light will illuminate.

ROTISSERIE

Press FUNCTION Button to select the ROTISSERIE. When the selection is made, the ROTISSERIE Light will illuminate.

TIME / TEMPERATURE / TOAST COLOR ARROWS

▲ ▼ Press to adjust the cooking TIME / TEMPERATURE.

(Hint: Holding the ARROW down in place will either fast forward ▲, or fast reverse ▼ the time.)

TIME / TEMP

Press to toggle between TIME and TEMPERATURE settings. Press to set time for TOAST, BAKE, BROIL, DEFROST, KEEP WARM or ROTISSERIE Functions. Use to change temperature settings for BAKE, DEFROST, KEEP WARM or ROTISSERIE.

CLOCK

Press to set the time for the Clock. AM and PM will appear in the top left corner of the Display Window.

LIGHT

Press the LIGHT Button to turn the Interior Oven Light ON or OFF. To replace the Oven Light see page 30

START/STOP

After selecting the FUNCTION, TEMPERATURE (if required) and TIME (if required), press to START the function. Press and hold the START/STOP Button to cancel a function and turn the Convection Oven OFF.

OPERATING INSTRUCTIONS

BEFORE USING FOR THE FIRST TIME

1. Read all instructions in this manual carefully.
2. Carefully unpack your Convection Oven and remove all packaging materials.
3. Place your Convection Oven on a level surface such as a countertop or tabletop. Be sure the sides, back, and top of the Convection Oven are at least 4 inches away from any walls, cabinets, or objects on the counter or table.
4. Remove all stickers from the Convection Oven except the rating label located on the back.
5. Remove the Convection Oven Accessories: Wire Rack, Broil Insert, Bake/Broil Pan, Pizza Pan, Pizza Rack and Rotisserie Accessories: Meat Tines, Rotisserie Bar, Rotisserie Bar Remover and Drip Pan and wash in warm, soapy water. Rinse and dry thoroughly before placing in the Convection Oven.
6. Remove any dust that may have accumulated during packaging by simply wiping the Convection Oven exterior with a clean, damp cloth.
7. Do not use abrasive cleaners.
8. Do not put the Convection Oven cord or plug in water.
9. When you are ready to use the Convection Oven, plug the cord into a 120V AC outlet.
10. To eliminate any protective substance or oil that may have been used for packing and shipping, following the instructions outlined in this Use and Care Instruction Manual, set the Oven to BAKE at 450°F for about 15 minutes. A small amount of smoke and odor may be detected. This is normal.
11. To avoid scratching, marring, or discoloration, do not store anything on top of the Convection Oven during operation.

CAUTION: Appliance surfaces are hot during and after use.

CAUTION: Always wear protective, insulated oven mitts on hands when touching hot Convection Oven or hot dishes and food or when inserting or removing Wire Rack.

RACK POSITIONS

WIRE RACK, BROIL INSERT, BAKE/BROIL PAN, PIZZA PAN, PIZZA RACK AND DEHYDRATION RACKS (sold separately)

For best results use Bake/Broil Pan to BAKE, DEFROST, TOP BROWN, KEEP WARM and to minimize clean up due to spills. See Figure 4 on page 6 for all Wire Rack Positions.

When **TOASTING**, place bread directly on Wire Rack. Place in Rack Position 5.

When **BAKING**, you may either use the Bake/Broil Pan or Wire Rack and your own pan. Place into Rack Position 3 or 4 unless more height is required and then place into Rack Position 5 or 6.

When **BAKE/SLOW COOKING**, use the Wire Rack and your own pan. Place into Rack Position 3 or 4 unless more height is required and then place into Rack Position 5 or 6.

When **BROILING**, the Bake/Broil Pan, Broil Insert and the Wire Rack must be used. Place into Rack Position 2, 3 or 4 depending on thickness of food. The food should be 1-1/2 to 2 inches from the top elements.

When **BAKE/ROASTING**, the Bake/Broil Pan, Broil Insert or Wire Rack and your own pan may be used. Place into Rack Position 5 or 6.

When **DEFROSTING**, you may either use the Bake/Broil Pan or your own pan. Place pan directly on Wire Rack. Place in Rack Position 3 or 4 unless more height is required and then place in Rack Position 5 or 6.

Place the **PIZZA** Pan, directly onto the Pizza Rack. Place into Rack Position 4 or 5 for best cooking results.

When using the **DEHYDRATION** Racks (sold separately), 1, 2 or 3 Racks may be used at one time; place each Dehydration Rack into Positions in 1, 3 and 5.

Please see page 21 for information on **ROTISSERIE** setup.

SETTING THE CLOCK

1. Plug unit into a 120 V AC electric outlet. Both the TIME and TOAST Lights will be illuminated; 9:20 will appear in the Display Window.
2. Press the CLOCK Button and 10:00 will appear in the Display Window; the COLON (:) will begin to flash. Press the CLOCK Button again; the "10" (HOUR) will begin to flash. Press the ▲ Up ARROW or the ▼ Down ARROW until the correct HOUR including AM or PM appears in the Display Window.
3. Press the CLOCK Button and the "00" (MINUTES) will begin to flash. Press the ▲ Up ARROW or the ▼ Down ARROW until the correct MINUTES appears in the Display Window.
4. Press the CLOCK Button. The COLON (:) will begin to flash. The clock is now set.

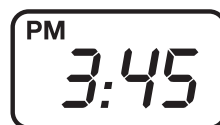

CONVECTION OVEN FUNCTIONS PROGRAMMING THE TOAST FUNCTION

Your Convection Oven will accommodate up to 6 slices of bread for toasting. The TOAST function may also be used to top brown foods.

1. Plug unit into a 120 V outlet. Close the Glass Door.

NOTE: When your Convection Oven is first plugged in, it defaults to the TOAST function. Both the TIME and TOAST Lights will be illuminated, 9:20 will appear in the Display Window.

2. Press the FUNCTION Button until the TOAST Light illuminates and the selection is made. Press the TIME/TEMP Button until the TIME Light illuminates; 9:20 appears in the Display Window; the center Toast Color Indicator Light will be lit to indicate medium browning.
3. There are 5 possible preset browning colors/times. To change the TOAST color/time, press the ▲ Up ARROW for a darker setting (the Display will change time from 9:20 medium toast color to 11:00 darkest toast color) or press the ▼ Down ARROW for a lighter setting (the Display will change time from 9:20 to 8:00 for the lightest toast color).

Toast Color Indicator Lights

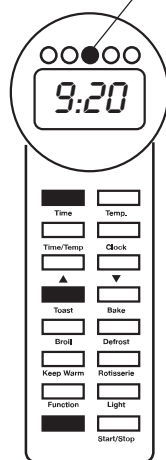

Figure 6
TOAST Control
Panel Lights

CONVECTION OVEN FUNCTIONS *(CONTINUED)*

NOTE: If you press the TIME/TEMP Button again, the TEMP Light will illuminate and 450°F will appear in the Display Window. When using the TOAST function, the TEMPERATURE cannot be changed.

4. Open the Glass Door and place bread or toaster food on the Wire Rack and place in Rack Position 4 or 5.
5. Close Glass Door.
6. Press the START/STOP Button. The ON/OFF Light will illuminate; toasting will begin; the time for the selected toast color will appear in the Display Window and begin to count down.
7. Condensation may build-up on the inside of the Glass Door, but will evaporate during toasting.

NOTE: Consecutive toasting may require less time, due to the Convection Oven Cavity already being heated. No adjustment of the color control is necessary to toast the same color. Color adjustment is only necessary if you would like the toast to be a lighter or darker shade.

8. When the time has elapsed, Display Window will show the time required for a consecutive batch of the same color toast; the Convection Oven will beep 5 times and the ON/OFF Light will turn off as a signal that the TOAST function is completed.
9. Using oven mitts, carefully pull the Wire Rack out and remove toast or toasted food.
10. Press the CLOCK Button and the Display Window will revert to show the time of day.
11. Unplug Oven and allow to cool completely before cleaning. See User Maintenance Instructions. Unplug when not in use.

NOTE: To change the toast color/time during the TOAST process, you must start the programming sequence over. Press the START/STOP Button and reset.

HINTS FOR TOAST

- Follow toaster food directions.
- Frozen and heavy breads such as bagels and English muffins require a darker setting (more time).

CONVECTION OVEN FUNCTIONS (CONTINUED)

PROGRAMMING THE BAKE FUNCTION

1. Plug unit into a 120 V outlet. Close the Glass Door.
2. Press the FUNCTION Button. When the BAKE Light illuminates, the selection is made. Press the TIME/TEMP Button until the TEMP Light illuminates; 350°F appears in the Display Window.
3. Press the ▲ Up ARROW for a higher BAKE temperature (up to 450°F) in 25 degree increments.
Press the ▼ Down ARROW for a lower BAKE temperature (down to 100°F) in 25 degree increments.
4. Press the TIME/TEMP Button until the TIME Light illuminates; 0:30 (30 MINUTES) appears in the Display Window.

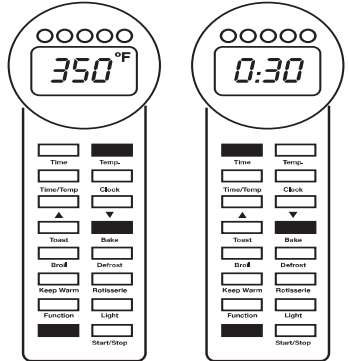

Figure 7
BAKE Control Panel Lights

5. To preheat the Oven, change the BAKE time to 0:10 minutes by pressing the ▼ Down ARROW.
6. Press the START/STOP Button. The ON/OFF Light will illuminate; PREHEAT BAKE will begin; the PREHEAT BAKE time will appear in the Display Window and begin to count down.
7. When the time has elapsed, the Display Window will show the default time of 0:30 (30 MINUTES), the Convection Oven will beep 5 times and the ON/OFF Light will turn off as a signal that the PREHEAT BAKE is complete.
8. To program the Oven for BAKE once the Oven is preheated, repeat steps 2 through 4 setting the FUNCTION, TEMPERATURE, and TIME according to package instructions, then proceed to step 9.
9. Press the START/STOP Button. The ON/OFF Light will illuminate; BAKE will begin; the BAKE time will appear in the Display Window and begin to count down.

NOTE: Convection baking will cook some foods faster. Check 5-10 minutes before the end of the suggested bake time. Continue baking if necessary.

10. When the BAKE time has elapsed, the Display Window will show the default time of 0:30 (30 MINUTES), the Convection Oven will beep 5 times and the ON/OFF Light will turn off as a signal that the BAKE function is complete.
11. Using oven mitts, carefully pull the Wire Rack out and remove cooked food.
12. Press the CLOCK Button and the Display Window will revert to show the time of day.

CONVECTION OVEN FUNCTIONS (CONTINUED)

13. Unplug Oven and allow to cool completely before cleaning. See User Maintenance Instructions. Unplug when not in use.

NOTE: To adjust the BAKE TIME or TEMPERATURE during the BAKE process, you must start the programming sequence over. Press the START/STOP Button and reset.

PROGRAMMING THE BAKE/SLOW COOK FUNCTION

1. Plug unit into a 120 V outlet. Close the Glass Door.
2. Press the FUNCTION Button. When the BAKE Light illuminates, the selection is made. Press the TIME/TEMP Button until the TEMP Light illuminates; 350°F appears in the Display Window.
3. Press the ▼ Down ARROW for a lower SLOW COOK temperature; the most common SLOW COOK temperature is 250°F.
4. Press the TIME/TEMP Button until the TIME Light illuminates; 0:30 (30 MINUTES) appears in the Display Window.
5. To change the BAKE time, press the ▲ Up ARROW to extend the time (up to 4:00 hours) or press the ▼ Down ARROW for a shorter BAKE time.
6. Open the Glass Door and carefully center baking dish directly on Bake/Broil Pan or Wire Rack in the center of the Oven and close Oven Door.
7. Press the START/STOP Button. The ON/OFF Light will illuminate; BAKE/SLOW COOK will begin; the BAKE time will appear in the Display Window and begin to count down.
8. Convection baking will cook some foods faster. Check 5 to 10 minutes before the end of the suggested bake time. Continue baking if necessary.

NOTE: Do not open the Door during the first 2 hours of SLOW COOKING.

9. When the time has elapsed, the Display Window will show the default time of 0:30, the Convection Oven will beep 5 times and the ON/OFF Light will turn off as a signal that the BAKE/SLOW COOK function is completed.
10. Using oven mitts, carefully pull the Wire Rack or Bake/Broil Pan out and remove cooked food.
11. Press the CLOCK Button and the Display Window will revert to show the time of day.
12. Unplug Oven and allow to cool completely before cleaning. See User Maintenance Instructions. Unplug when not in use.

NOTE: To adjust the BAKE/SLOW COOK time or temperature during the BAKE process, you must start the programming sequence over. Press the START/STOP Button and reset.

HINTS FOR SLOW COOK

Recipes may be used to SLOW COOK by using the following guidelines.

- All baking dishes should be covered. Aluminum foil may be used if ends are tucked against edge of pan.
- Ovenproof glass and ceramic dishes are recommended.
- Aluminum foil pans and pans that will rust, such as cast iron or tin should not be used.
- Separate dishes can cook simultaneously, yet food retains its own flavor. Select foods that will take the same amount of time to cook.
- Milk, cream and sour cream may curdle. It is best to add them in the last hour of cooking. If a recipe specifies one of these ingredients as the only liquid in the cooking process, try substituting evaporated milk, water or condensed soup, such as cream of mushroom or chicken soup.
- Slow cooking enhances the flavor of spices and salt. We recommend you reduce seasoning in your own recipes.
- Precooked spaghetti and pasta products should be added in the last hour of slow cooking.

PROGRAMMING THE BAKE/ROAST FUNCTION

1. Plug unit into a 120 V outlet. Close the Glass Door.
2. Press the FUNCTION Button. When the BAKE Light illuminates, the selection is made. Press the TIME/TEMP Button until the TEMP Light illuminates; 350°F appears in the Display Window.
3. To change the BAKE temperature, press the ▲ Up ARROW for a higher temperature (up to 450°F) or press the ▼ Down ARROW for a lower BAKE temperature (down to 100°F). Refer to the Roasting Chart on the next page for recommended cooking temperatures.
4. Press the TIME/TEMP Button until the TIME Light illuminates; 0:30 (30 MINUTES) appears in the Display Window.
5. To change the BAKE time, press the ▲ Up ARROW to extend the time (up to 4:00 hours) or press the ▼ Down ARROW for a shorter BAKE time.
6. Open the Glass Door and carefully center baking dish directly on Bake/Broil Pan or Wire Rack and close Oven Door.
7. Press the START/STOP Button. The ON/OFF Light will illuminate; BAKE will begin; the BAKE time will appear in the Display Window and begin to count down.
8. Convection baking will cook some foods faster. Check 5 to 10 minutes before the end of the suggested bake time. Continue baking if necessary.

CONVECTION OVEN FUNCTIONS *(CONTINUED)*

9. When the time has elapsed, the Display Window will show the default time of 0:30, the Convection Oven will beep 5 times and the ON/OFF Light will turn off as a signal that the BAKE function is completed.
10. Using oven mitts, carefully pull the Wire Rack out and remove cooked food.
11. Press the CLOCK Button and the Display Window will revert to show the time of day.
12. Unplug Oven and allow to cool completely before cleaning. See User Maintenance Instructions. Unplug when not in use.

NOTE: To adjust the BAKE time or temperature during the BAKE process, you must start the programming sequence over. Press the START/STOP Button and reset.

INTERNAL TEMPERATURE ROASTING CHART

CUT	INTERNAL TEMPERATURE
Beef	145°F Rare 160°F Medium 170°F Well Done
Ham (fresh)	160°F
Ham (precooked)	140°F
Lamb	160°F Medium Well 170°F Well Done
Pork	160°F Medium 170°F Well Done
Turkey or Chicken, Whole	180°F
Turkey or Chicken, Breast	170°F

USDA RECOMMENDED TEMPERATURES

The United States Department of Agriculture recommends that meat and poultry be cooked to the following internal temperatures to be sure any harmful bacteria has been killed. Ground turkey and chicken should be cooked to an internal temperature of 165° F and ground beef, veal, lamb and pork be cooked to an internal temperature of 160° F. Chicken and turkey should be cooked to an internal temperature of 170° F for white meat and 180° F for dark meat. Goose and duck should be cooked to an internal temperature of 180° F. Fresh beef, veal and lamb, etc. should be cooked to an internal temperature of at least 145° F. Fresh pork should be cooked to an internal temperature of at least 160° F. When re-heating meat and poultry products, they should also be cooked to an internal temperature of 165° F.

HINTS FOR ROAST

- A meat thermometer inserted into the center of the meat should always be used to ensure meat is cooked to desired doneness.
- Roasting is recommended for large, tender cuts of meat and poultry. Seasoning prior to cooking adds to the flavor and the aroma during cooking.
- A layer of fat on the top of the roast promotes better browning and provides natural basting.
- When roasting meats with a high fat content, the Bake/Broil Pan may fill with grease before cooking is completed. If this occurs, carefully remove the Bake/Broil Pan using oven mitts and empty. Replace for continued roasting.

PREPARING PIZZA IN YOUR CONVECTION OVEN

This Convection Oven has been specially designed to accommodate a 12-inch pizza.

1. Plug unit into a 120 V outlet. Remove all racks and pans from the Oven. Close the Glass Door.
2. Press the FUNCTION Button. When the BAKE Light illuminates, the selection is made. Press the TIME/TEMP Button until the TEMP Light illuminates; 350°F appears in the Display Window.
3. Press the ▲ Up ARROW or ▼ Down ARROW and adjust to BAKE temperature suggested on the pizza box.
4. Press the TIME/TEMP Button until the TIME Light illuminates; 0:30 (30 MINUTES) appears in the Display Window.
5. Press the ▼ Down ARROW and adjust time to :10 to allow the Oven to preheat for 10 minutes. Press the START/STOP Button. The ON/OFF Light will illuminate; BAKE will begin; the BAKE time will begin to count down. The Oven will turn itself OFF when 10 minutes have elapsed; the Oven is ready to bake your pizza.
6. Place pizza directly on Pizza Rack or in the Pizza Pan provided and then place on Pizza Rack. Close the Glass Door.
7. Following the instructions outlined in the PROGRAMMING THE BAKE FUNCTION section of this manual, program the temperature and then the time, as indicated on the pizza package.
8. Press the START/STOP Button. The ON/OFF Light will illuminate; BAKE will begin; the BAKE time will appear in the Display Window and begin to count down.
9. When the time has elapsed, the Display Window will show the default time of 0:30, the Convection Oven will beep 5 times and the ON/OFF Light will turn off as a signal that the BAKE function is completed.
10. When the pizza is finished baking, using oven mitts, carefully remove Pizza Pan and/or Pizza Rack with pizza.
11. Press the CLOCK Button and the Display Window will revert to show the time of day.
12. Unplug Oven and allow to cool completely before cleaning. See User Maintenance Instructions. Unplug when not in use.

NOTE: To adjust the BAKE time or temperature during the BAKE process, you must start the programming sequence over. Press the START/STOP Button and reset.

PROGRAMMING THE BROIL FUNCTION

1. Plug unit into a 120 V outlet. Close the Glass Door.
 2. Press the FUNCTION Button. When the BROIL Light illuminates, the selection is made. Press the TIME/TEMP Button until the TEMP Light illuminates; 450°F appears in the Display Window.
 3. The BROIL temperature is fixed and cannot be changed.
 4. Press the TIME/TEMP Button until the TIME Light illuminates; 0:30 (30 MINUTES) appears in the Display Window.
 5. To change the BROIL time, press the ▲ Up ARROW to extend the time (up to 4:00 hours) or press the ▼ Down ARROW for a shorter BROIL time. Refer to the Broil Time Chart on the next page for recommended cooking times.
 6. Place the Broil Insert in the Bake/Broil Pan. Always use the Bake/Broil Pan and Broil Insert when broiling. Place food on Broil Insert and position the Bake/Broil Pan in shelf position 1. Juices and fat will drip into the pan and decrease spattering while broiling. Close the Door.
 7. Press the START/STOP Button. The ON/OFF Light will illuminate; BROIL will begin; the BROIL time will appear in the Display Window and begin to count down.
 8. Broil food until done, turning half way through cooking time. Carefully remove Bake/Broil Pan and Broil Insert from Oven using oven mitts.
 9. When the time has elapsed, the Display Window will show the default time of 0:30, the Convection Oven will beep 5 times and the ON/OFF Light will turn off as a signal that the BROIL function is completed.
 10. Unplug and allow to cool completely before cleaning.
 11. Press the CLOCK Button and the Display Window will revert to show the time of day.
 12. Unplug Oven and allow to cool completely before cleaning. See User Maintenance Instructions. Unplug when not in use.
- NOTE: To adjust the BROIL time during the BROIL process, press the START/STOP Button and reset.**

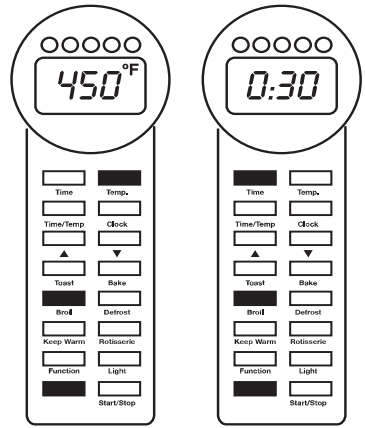

Figure 8
BROIL Control Panel Lights

BROIL RECOMMENDATIONS

Broiling is used for tender cuts of meats or marinated meats, fish and some fruits and vegetables. Cooking time is determined by the desired doneness and the distance between the food and the element. The following chart is to be used as a guideline.

BROIL TIME CHART

FOOD	TOTAL COOK TIME*
Beef Steaks (3/4inch thick)	22 to 28 minutes
Ham Steak (1inch thick)	25 to 30 minutes
Fish Fillet	8 to 12 minutes
Fish Steak (1inch thick)	10 to 14 minutes
Ground Beef (3/4inch thick)	25 to 30 minutes
Hot Dogs	10 to 20 minutes

***Turn food halfway through cooking time. Broil times are approximate and may vary depending on meat**

NOTES: To speed up browning, brush lean cuts of meat, chicken and fish with oil, margarine or melted butter. Broiling times indicated are for fresh meat at refrigerator temperature.

HINTS FOR BROIL

- Do not place aluminum foil on top of Broil Insert. This traps grease and can cause a fire.
- Trim excess fat from meat and score edges to prevent curling and thaw frozen meats before broiling. This will reduce smoke during broiling.

ROTISSERIE AND ROTISSERIE ACCESSORIES

Using the Rotisserie to cook meats and poultry allows them to self-baste in their own juices. This seals in flavor while any excess fat drips off of the food. The food being cooked on the Rotisserie must be no wider than 12 inches and should weigh no more than 10 pounds. This allows the entire piece of food to be over the Heating Elements. The food should be placed onto the Rotisserie Bar with the Prongs securely in place, see below. The Rotisserie may be used with the BROIL Function. Check your food prior to the time it should be done and continue cooking as necessary.

Rotisserie Meat Tines (P/N 21434)

Use for whole turkeys, chickens, cornish hens, roast, etc. When using, be sure to place 1 at each end of the meat on the Rotisserie Bar.

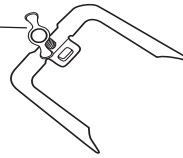

Rotisserie Bar (P/N 22644)

Fits into the Oven. The heavy duty Oven Motor turns the bar so the food cooks evenly and conveniently.



Rotisserie Bar Remover (P/N 22645)

Use to remove the Rotisserie Bar from the Oven.

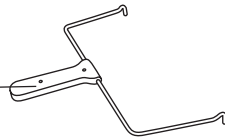

Drip Pan (P/N 22646)

Use to catch drippings from meat during Rotisserie cooking process.

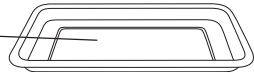

Figure 9
Rotisserie Accessories

ROTISSERIE SETUP

1. Place Drip Pan into bottom of Oven between the 2 heating elements.
2. Carefully center the food on Rotisserie Bar using the Meat Tines to secure the food in place. (See Figure 10.) If the food is not centered it will cause a jerking motion during cooking. This results in undue stress on the Motor.

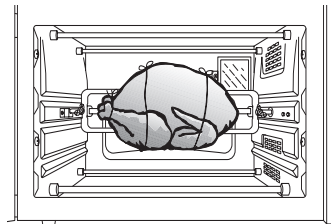

Figure 10

CONVECTION OVEN FUNCTIONS (CONTINUED)

- Place the round pointed end of Rotisserie Bar into opening on the right side Oven Wall. Place the opposite end of the Rotisserie Bar into the Bracket on the left side Oven Wall. (See Figures 11 and 12.)

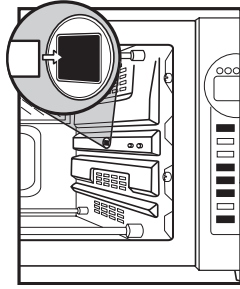

Figure 11

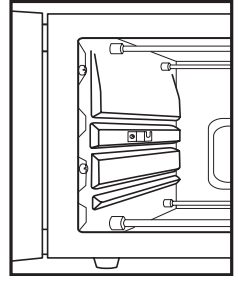

Figure 12

PROGRAMMING THE ROTISSERIE FUNCTION

- Insert Rotisserie Bar with food into Oven.
- Plug unit into a 120 V outlet. Close the Glass Door.
- Refer to the ROTISSERIE TIME AND TEMPERATURE CHART on page 24 for suggested times and cooking temperatures. Press the FUNCTION Button. When the ROTISSERIE Light illuminates, the selection is made. Press the TIME/TEMP Button until the TEMP Light illuminates; 350°F appears in the Display Window.

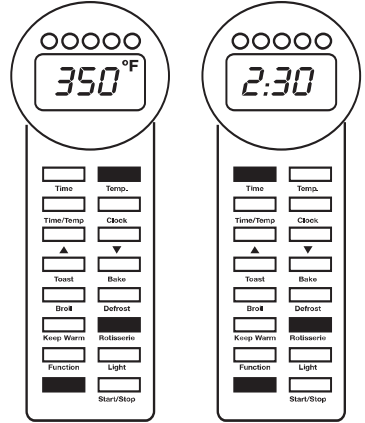

Figure 13
ROTISSERIE Control Panel Lights

- Press the ▼ Down ARROW for a lower ROTISSERIE temperature if desired; or press the ▲ Up ARROW to raise the cooking temperature.
- Press the TIME/TEMP Button until the TIME Light illuminates; 2:30 (2 HOURS, 30 MINUTES) appears in the Display Window.
- To change the ROTISSERIE time, press the ▲ Up ARROW to extend the time (up to 4:00 hours) or press the ▼ Down ARROW for a shorter ROTISSERIE time.
- Press the START/STOP Button. The ON/OFF Light will illuminate; the Oven will begin heating; the ROTISSERIE will begin turning; the time for the ROTISSERIE function will appear in the Display Window and begin to count down.

CONVECTION OVEN FUNCTIONS (CONTINUED)

NOTE: Since meats and poultry roast faster in a Convection Oven, a meat thermometer should always be used to gauge internal temperature. The thermometer should be inserted into the thickest portion of meat away from bones or fatty areas. Check progress two thirds into the cooking process to ensure meat does not over cook.

8. When the time has elapsed, the Display Window will show the default time of 2:30, the Convection Oven will beep 5 times and the ON/OFF Light will turn off as a signal that the ROTISSERIE function is completed.
9. When finished, **using protective oven mitts** and the Rotisserie Bar Remover, carefully remove Rotisserie Bar with food from the Oven.
10. Allow food to cool 15 to 20 minutes before removing food from Rotisserie Bar and carving.

CAUTION: DO NOT CARVE MEAT WHILE IT IS IN THE OVEN OR ON THE ROTISSERIE BAR.

11. Press the CLOCK Button and the Display Window will revert to show the time of day.
12. Unplug Oven and allow to cool completely before cleaning. See User Maintenance Instructions. Unplug when not in use.

NOTE: To adjust the ROTISSERIE cook time or temperature while cooking, you must start the programming sequence over. Press the START/STOP Button and reset.

ROTISSERIE TIME AND TEMPERATURE CHART

CUT OF MEAT	APPROX. WEIGHT (lbs.)	OVEN TEMP	INTERNAL TEMP	APPROX. ROTISSERIE TIME
Rib Eye Roast	6 - 10	350° F	145° F (med-rare) 160° F (med)	2:30 3:00
Eye of Round Roast	4 - 6	400° F	145° F (med-rare) 160° F (med)	1:00 1:15
Center Loin (boneless)	4 - 6	325° F	160° F	1:00
Center Loin (boneless, 2 tied together)	6 - 10	325° F	160° F	2:15
Pork Shoulder Boston Butt Roast (boneless)	3	325° F	160° F	2:30
Turkey	8 - 10	325° F	180° F	2:15
Chicken	4 - 6	375° F	180° F	1:15
Duck	5 - 8	350° F	180° F	2:00
Leg (semi-boneless)	4 - 7	325° F	160° F (med) 170° F (well)	2:15 2:30

HINTS FOR ROTISSERIE

- A meat thermometer inserted into the thickest part of the meat or poultry should always be used to ensure desired doneness. Please refer to USDA recommended temperatures.
- Rotisserie cooking is recommended for large, tender cuts of meat and poultry.
- Seasoning prior to cooking adds to the flavor and the aroma during cooking.
- Do not spray any type of aerosol spray flavoring inside the Oven Cavity while cooking.
- Always center food on the Rotisserie Bar before cooking.
- To avoid burning the exterior of your food, do not baste food with barbeque sauce until the last 20 to 30 minutes of cooking.
- Once the food is placed inside the Oven Cavity, watch the food while the Rotisserie rotates at least 1 complete turn to ensure proper clearance of the Heating Elements and Drip Pan.

PROGRAMMING THE KEEP WARM FUNCTION

1. Plug unit into a 120 V outlet. Close the Glass Door.
2. Press the FUNCTION Button. When the KEEP WARM Light illuminates, the selection is made. Press the TIME/TEMP Button until the TEMP Light illuminates; 200°F appears in the Display Window. The KEEP WARM temperature is fixed and cannot be changed.
3. Press the TIME/TEMP Button until the TIME Light illuminates; 0:30 (30 MINUTES) appears in the Display Window.

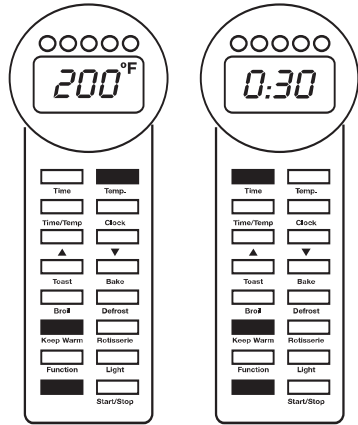

Figure 14
KEEP WARM Control Panel Lights

4. To change the KEEP WARM time, press the ▲ Up ARROW to extend the time (up to 4:00 hours) or press the ▼ Down ARROW for a shorter KEEP WARM time.
5. Open the Glass Door and carefully center baking dish directly on Bake/Broil Pan or Wire Rack in the center of the Oven and close Oven Door.
6. Press the START/STOP Button. The ON/OFF Light will illuminate; KEEP WARM will begin; the KEEP WARM time will appear in the Display Window and begin to count down.
7. When the time has elapsed, the Display Window will show the default time of 0:30, the Convection Oven will beep 5 times and the ON/OFF Light will turn off as a signal that the KEEP WARM function is completed.
8. Using oven mitts, carefully pull the Wire Rack out and remove cooked food.
9. Press the CLOCK Button and the Display Window will revert to show the time of day.
10. Unplug Oven and allow to cool completely before cleaning. See User Maintenance Instructions. Unplug when not in use.

PROGRAMMING THE DEFROST FUNCTION

1. Plug unit into a 120 V outlet. Close the Glass Door.
2. Press the FUNCTION Button. When the DEFROST Light illuminates, the selection is made. Press the TIME/TEMP Button until the TEMP Light illuminates; 175°F appears in the Display Window. The DEFROST temperature is fixed and cannot be changed.
3. Press the TIME/TEMP Button until the TIME Light illuminates; 2:30 appears in the Display Window.
4. To change the DEFROST time, press the ▲ Up ARROW to extend the time (up to 18:00 hours) or press the ▼ Down ARROW for a shorter DEFROST time.
5. Open the Glass Door and carefully center baking dish directly on Bake/Broil Pan or Wire Rack in the center of the Oven and close Oven Door.
6. Press the START/STOP Button. The ON/OFF Light will illuminate; DEFROST will begin; the DEFROST time will appear in the Display Window and begin to count down.
7. When the time has elapsed, the Display Window will show the default time of 2:30, the Convection Oven will beep 5 times and the ON/OFF Light will turn off as a signal that the DEFROST function is completed.
8. Using oven mitts, carefully pull the Wire Rack out and remove cooked food.
9. Press the CLOCK Button and the Display Window will revert to show the time of day.
10. Unplug Oven and allow to cool completely before cleaning. See User Maintenance Instructions. Unplug when not in use.

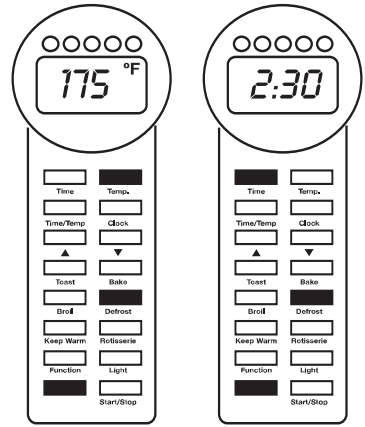

Figure 15
DEFROST Control Panel Lights

HINTS FOR DEFROST

- Do not use this method for meat, poultry, or fish.
- Do not cover food.
- Brush frozen dough with vegetable oil to prevent drying out.
- Remove food to preheat Oven before baking.
- DEFROST should take 1/3 of the time required for room temperature thawing.

PROGRAMMING THE DEFROST/DEHYDRATE FUNCTION

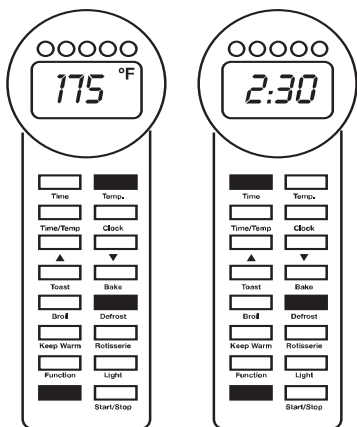

Figure 16
DEHYDRATE Control Panel Lights

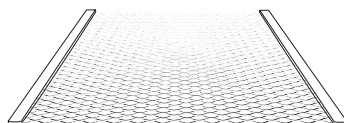

Figure 17
Dehydration Rack
(Set of 3 sold separately)
P/N 22684DEH

Dehydration Racks are required when using this function. They are not included with this Convection Oven but may be purchased separately. Contact our Consumer Relations Department by calling the number on the back of this Instruction Manual and ask for part number 22684DEH.

1. Plug unit into a 120 V outlet. Close the Glass Door.
2. Press the FUNCTION Button. When the DEFROST Light illuminates, the selection is made. Press the TIME/TEMP Button until the TEMP Light illuminates; 175°F appears in the Display Window. The DEFROST/DEHYDRATE temperature is fixed and cannot be changed.
3. Press the TIME/TEMP Button until the TIME Light illuminates; 2:30 appears in the Display Window.
4. To change the DEHYDRATE time, press the ▲ Up ARROW to extend the time (up to 18:00 hours) or press the ▼ Down ARROW for a shorter DEHYDRATE time.
5. Insert Dehydration Rack(s) with food.
6. Press the START/STOP Button. The ON/OFF Light will illuminate; DEFROST/DEHYDRATE will begin; the time will appear in the Display Window and begin to count down.

CONVECTION OVEN FUNCTIONS *(CONTINUED)*

7. When the time has elapsed, the Display Window will show the default time of 2:30, the Convection Oven will beep 5 times and the ON/OFF Light will turn off as a signal that the DEFROST/DEHYDRATE function is completed.
8. Using oven mitts, carefully pull the Racks out and remove cooked food.
9. Press the CLOCK Button and the Display Window will revert to show the time of day.
10. Unplug Oven and allow to cool completely before cleaning. See User Maintenance Instructions. Unplug when not in use.

HINTS FOR DEHYDRATE

- Food dehydration is an inexpensive, nutritious and easy way to prepare convenience foods.
- Time required for the process will vary with thickness and type of food being dehydrated.
- Guides to preparing foods for drying with Dehydration Racks may be found in cook books or on-line through the world wide web.

USER MAINTENANCE INSTRUCTIONS

This appliance requires little maintenance. It contains no user serviceable parts. Do not try to repair it yourself. Any servicing requiring disassembly other than cleaning, must be performed by a qualified appliance repair technician.

OVEN CARE AND CLEANING

To assure optimum safety, keep unit clean, free of grease and food buildup.

CAUTION: Unplug appliance and allow to cool completely before cleaning. Never place unit, electric cord or plug in water or other liquids.

CAUTION: Do not clean Oven with metal scouring pads. Pieces can break off and touch electrical parts, creating a risk of electric shock.

ACCESSORIES CLEANING

To clean the accessories: Bake/Broil Pan, Broil Insert, Wire Rack, Pizza Rack, Pizza Pan, Rotisserie Bar and Meat Tines, please follow the steps below.

1. Always unplug and allow to cool completely before cleaning or moving.
2. Remove Bake/Broil Pan, Broil Insert, Wire Rack, Pizza Rack, Pizza Pan, Drip Pan, Rotisserie Bar and Meat Tines.
3. Clean with a mild or non-abrasive cleaner and a plastic scouring pad. Accessories may be placed in the dishwasher for easy cleaning.
4. Rinse and dry thoroughly.

NONSTICK WALLS/INTERIOR CLEANING

1. Always unplug and allow to cool completely before cleaning or moving.
2. Remove Bake/Broil Pan, Broil Insert, Wire Rack, Pizza Rack, Pizza Pan, Drip Pan, Rotisserie Bar and Meat Tines.
3. Clean interior after each use to avoid buildup.
4. Clean with a mild or non-abrasive cleaner and a plastic scouring pad. Do not rub too hard as surface can be scratched.
5. Rinse and dry thoroughly before closing the Oven Door.

OVEN DOOR/EXTERIOR CLEANING

The Oven Door can be removed for easier cleaning. To remove, open fully and lift, clearing the hinge pins. To replace, slide the Door over the hinge pins, being sure to gently push Door all the way down on pins to avoid glass breakage.

1. Always unplug and allow to cool completely before cleaning or moving.
2. Clean with glass cleaner or mild detergent and damp cloth or plastic scouring pad. Do not use an abrasive cleaner or pad as they might mar the finish. The Door may be placed in the dishwasher for easy cleanup.
3. Rinse and dry thoroughly with a clean cloth. Allow to dry before closing Door.

TO REMOVE OVEN DOOR AND REPLACE OVEN LIGHT

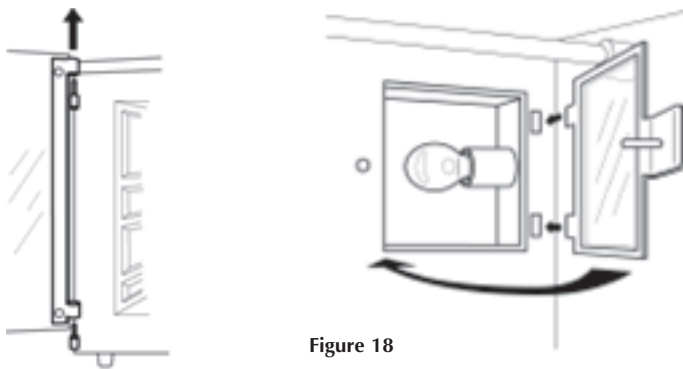

Figure 18

1. Unplug unit and allow Oven to cool completely.
2. To remove the Oven Door, open and lift upwards and off of the Door pins. (See Figure 18).
3. Remove screw from Oven Light Bracket, holding onto bracket to prevent glass from falling.
4. Remove bracket and glass.
5. Remove bulb by turning counterclockwise.
6. Replace with new bulb, turning clockwise.
7. Replace glass and bracket, being sure the two tabs on the bracket are in the slots provided for them on the Oven wall.
8. Replace bracket screw.

NOTE: Use only a 656 or equivalent 6-watt, 120 volt bulb. Do not operate the Oven without the Oven Lamp Glass in place.

FARBERWARE®

LIMITED ONE-YEAR WARRANTY

Warranty Coverage: This product is warranted to be free from defects in materials or workmanship for a period of one (1) year from the original purchase date. This product warranty is extended only to the original consumer purchaser of the product and is not transferable. For a period of one (1) year from the date of original purchase of the product, our Repair Center will, at its option, either (1) repair the product or (2) replace the product with a reconditioned comparable model. These remedies are the purchaser's exclusive remedies under this warranty.

Warranty Service: To obtain warranty service, you must call our warranty service number at 1-800-233-9054 for return instructions on how to deliver the product, in either the original packaging or packaging affording an equal degree of protection to the Repair Center specified below. You must enclose a copy of your sales receipt or other proof of purchase to demonstrate eligibility for warranty coverage.

To return the appliance, ship to:

ATTN: Repair Center
708 South Missouri Street
Macon, MO 63552 USA

To contact us, please write to, call, or email:

Consumer Relations Department
PO Box 7366
Columbia MO 65205-7366 USA
1-800-233-9054
E-mail: consumer_relations@toastmaster.com

What Is Not Covered: This warranty does not cover damage resulting from misuse, accident, commercial use, improper service or any other damage caused by anything other than defects in material or workmanship during ordinary consumer use. This warranty is invalid if the serial number has been altered or removed from the product. This warranty is valid only in the United States and Canada.

LIMITATION ON DAMAGES: THERE SHALL BE NO LIABILITY FOR ANY INCIDENTAL OR CONSEQUENTIAL DAMAGES FOR BREACH OF ANY EXPRESS OR IMPLIED WARRANTY OR CONDITION ON THIS PRODUCT.

DURATION OF IMPLIED WARRANTIES: EXCEPT TO THE EXTENT PROHIBITED BY APPLICABLE LAW, ALL IMPLIED WARRANTIES AND CONDITIONS, INCLUDING, WITHOUT LIMITATION, IMPLIED WARRANTIES AND CONDITIONS OF MERCHANTABILITY AND FITNESS FOR A PARTICULAR PURPOSE OR USE ON THIS PRODUCT ARE LIMITED IN DURATION TO THE DURATION OF THIS WARRANTY.

Some jurisdictions do not allow the exclusion or limitation of incidental or consequential damages, or allow limitations on how long an implied warranty lasts, so the above limitations or exclusions may not apply to you. This warranty gives you specific legal rights and you may have other rights under the laws of your jurisdiction.

FARBERWARE® and Millennium® are registered trademarks of Farberware Inc.®
Manufactured and sold pursuant to a license from Farberware Inc.®

For more information on our products, visit our website:
www.maxim-toastmaster.com.

©2005 All rights reserved.
Made in China

P/N 61702
8/05