

This Owner's Manual is provided and hosted by [Appliance Factory Parts](#).



Weber 1500092 Owner's Manual

[Shop genuine replacement parts for Weber 1500092](#)



[Find Your Weber Grill Parts - Select From 2037 Models](#)

----- Manual continues below -----

GENESIS



S-315 • S-415 • E-325 • SA-E-325 • SP-S-325
E-330 • SA-E-330
E-335 • S-335 • E-335C • S-335C
SP-E-335 • SP-S-335

LP Owner's Manual

Keep this Owner's Manual for future reference, thoroughly read through it, and if you have any questions please contact us today.



REGISTER TODAY

Register your gas grill and receive special content to make you the ultimate backyard hero.

Scan the QR Code or register online at weber.registria.com

Important Safety Information

DANGER, WARNING, and CAUTION

statements are used throughout this Owner's Manual to emphasize critical and important information. Read and follow these statements to help ensure safety and prevent property damage. The statements are defined below.

⚠ DANGER: Indicates a hazardous situation which, if not avoided, *will result in death or serious injury.*

⚠ WARNING: Indicates a hazardous situation which, if not avoided, *could result in death or serious injury.*

⚠ CAUTION: Indicates a hazardous situation which, if not avoided, *could result in minor or moderate injury.*

USE OUTDOORS ONLY.

READ THE INSTRUCTIONS BEFORE USING THE APPLIANCE (GRILL).

NOTICE TO INSTALLER: These instructions must be left with the consumer.

NOTICE TO CONSUMER: Retain these instructions for future reference.

⚠ DANGER

If you smell gas:

- Shut off gas to the appliance (grill).
- Extinguish any open flame.
- Open lid.
- If odor continues, keep away from the appliance (grill) and immediately call your gas supplier or your fire department.

⚠ WARNING

- Do not store or use gasoline or other flammable liquids or vapors in the vicinity of this (grill) or any other appliance.
- An LP cylinder (tank) not connected for use shall not be stored in the vicinity of this (grill) or any other appliance.

Installation and Assembly

- ⚠ **DANGER:** This grill is not intended to be installed in or on recreational vehicles or boats.
- ⚠ **WARNING:** Do not use this grill unless all parts are in place and the grill was properly assembled according to the assembly instructions.
- ⚠ **WARNING:** Do not build this model of grill in any built-in or slide-in construction.
- ⚠ **WARNING:** Do not modify the appliance (grill). Liquid propane gas is not natural gas. The conversion or attempted use of natural gas in a liquid propane gas unit or liquid propane gas in a natural gas unit is unsafe and will void your warranty.
- In the United States, installation must conform with local codes or, in the absence of local codes, with either the National Fuel Gas Code, ANSI Z223.1/NFPA 54, Natural Gas and Propane Installation Code, CSA B149.1; or Propane Storage and Handling Code, B149.2; or the Standard for Recreational Vehicles, ANSI A119.2/NFPA 1192, and CSA Z240 RV Series, Recreational Vehicle Code, as applicable.
- In Canada, the installation of this grill must comply with local codes and/or the latest edition of Standard CAN/CSA-B149.2 (Propane Storage and Handling Code). These instructions, while generally acceptable, do not necessarily comply with the Canadian installation codes, particularly with piping above and below ground.
- In Mexico, if there are local codes that apply to portable gas appliances, you must comply with the latest edition of Official Mexican Standard (NOM).
- If an external electrical source is utilized (such as a rotisserie) it must be electrically grounded in accordance with local codes or, in the absence of local codes, with the National Electrical Code, ANSI/NFPA 70, or the Canadian Electrical Code, Part 1, CSA C22.1.

Operation

- ⚠ **DANGER:** Only use the grill outdoors in a well-ventilated area. Do not use in a garage, building, breezeway, tent, any other enclosed area, or beneath overhead combustible construction.
- An appliance is considered to be outdoors if installed with shelter no more inclusive than with walls on three sides, but with no overhead cover; all openings must be permanently open; sliding doors, garage doors, windows, or screened openings are not considered as permanent openings.
- An appliance is considered to be outdoors if installed with shelter no more inclusive than within a partial enclosure that includes an overhead cover and no more than two sidewalls. The sidewalls may be parallel, as in a breezeway, or at right angles to each other; all openings must be permanently open; sliding door, garage doors, windows, or screened openings are not considered as permanent openings.
- An appliance is considered to be outdoors if installed with shelter no more inclusive than within a partial enclosure that included an overhead cover and three sidewalls, as long as 30% or more of the horizontal periphery of the enclosure is permanently open. All openings must be permanently open; sliding doors, garage doors, windows, or screened openings are not considered as permanent openings.
- The minimum ambient operating temperature for safe use of the appliance shall be 32° F (0° C).
- ⚠ **DANGER:** Do not use the grill in any vehicle or in any storage or cargo area of any vehicle. This includes, but is not limited to, cars, trucks, station wagons, mini-vans, sport utility vehicles, recreational vehicles, and boats.
- ⚠ **DANGER:** Do not use the grill within 24 inches (61 cm) of combustible materials. This includes the top, bottom, back and sides of the grill.
- ⚠ **DANGER:** Keep the cooking area clear of flammable vapors and liquids such as gasoline, alcohol, etc., and combustible materials.
- ⚠ **DANGER:** This appliance (grill) must be kept away from flammable materials during use.



FEATURES OF THIS GRILL

To access complete user information, scan the QR Code and enter your serial number, or browse online at

weber.com/literature-online

Serial Number

Write your grill's serial number in the box above for future reference. The serial number is on the grill's data label.

8651850_083123 enUS

- ⚠ **DANGER:** Do not put a grill cover or anything flammable on, or in the storage area under the grill while it is in operation or is hot.
- ⚠ **DANGER:** Should a grease fire occur, turn off all burners and leave lid closed until fire is out.
- ⚠ **WARNING:** Accessible parts may be very hot. Keep young children away.
- ⚠ **WARNING:** The use of alcohol, prescription drugs, non-prescription drugs, or illegal drugs may impair the consumer's ability to properly and safely assemble, move, store, or operate the grill.
- ⚠ **WARNING:** Never leave the grill unattended during pre-heating or use. Exercise caution when using this grill. The entire cookbox gets hot when in use.
- ⚠ **WARNING:** Do not move the appliance (grill) during use.
- ⚠ **WARNING:** Keep any electrical supply cord and the fuel supply hose away from any heated surfaces.
- ⚠ **CAUTION:** This product has been safety-tested and is only certified for use in a specific country. Refer to country designation located on outside of box.
 - Do not use charcoal or lava rock in the grill.

Storage and/or Non-Use

- ⚠ **WARNING:** Turn off the gas supply at the gas cylinder (tank) after use.
- ⚠ **WARNING:** LP tanks must be stored outdoors out of the reach of children and must not be stored in a building, garage, or any other enclosed space.
- ⚠ **WARNING:** After a period of storage and/or nonuse, the grill should be checked for gas leaks and burner obstructions before use.
- ⚠ Storage of the grill indoors is permissible only if the LP tank is disconnected and removed from the grill.

California Proposition 65

- ⚠ **WARNING:** Combustion byproducts produced when using this product contain chemicals known to the state of California to cause cancer, birth defects, or other reproductive harm.
- ⚠ **PROPOSITION 65 WARNING:** Handling the brass material on this product exposes you to lead, a chemical known to the state of California to cause cancer, birth defects, or other reproductive harm. *Wash hands after handling this product.*

Electrical Supply

- ⚠ **WARNING:** This appliance is not intended for use by persons (including children) with reduced physical, sensory or mental capabilities, or lack of experience and knowledge, unless they have been given supervision or instruction concerning use of the appliance by a person responsible for their safety.
- ⚠ **WARNING:** Children should be supervised to ensure that they do not play with the appliance.
- ⚠ **WARNING:** Only use the power supply unit provided with this appliance.
- ⚠ **WARNING:** This appliance incorporates an earth connection for functional purposes only.
- ⚠ **WARNING:** To protect against risk of electric shock, do not immerse cord or plugs in water or other liquid.
- ⚠ **WARNING:** Unplug from outlet when not in use and before cleaning. Allow to cool before putting on or taking off parts.
- ⚠ **WARNING:** Do not operate any outdoor cooking gas appliance with a damaged cord, plug, or after the appliance malfunctions or has been damaged in any manner. Contact the Customer Service Representative in your area using the contact information on our web site. Log onto www.weber.com.
- ⚠ **WARNING:** Do not let the cord hang over the edge of a table or touch hot surfaces.
- ⚠ **WARNING:** Do not use an outdoor cooking gas appliance for purposes other than intended.
- ⚠ **WARNING:** When connecting, first connect the plug to the outdoor cooking gas appliance then plug appliance into the outlet.
- ⚠ **WARNING:** Use only a Ground Fault Interrupter (GFI) protected circuit with this outdoor cooking gas appliance.
- ⚠ **WARNING:** Never remove the grounding plug or use with an adapter of 2 prongs.
- ⚠ **WARNING:** Use only extension cords with a 3 prong grounding plug, rated for the power of the equipment, and approved for outdoor use with a W-A marking.
 - Do not connect two or more extension cords together.

Limited Warranty

Thank you for purchasing a WEBER product. Weber-Stephen Products LLC, 1415 S. Roselle Road, Palatine, Illinois 60067 ("WEBER") prides itself on delivering a safe, durable, and reliable product. This is WEBER's Limited Warranty ("Warranty") provided to you at no extra charge. It contains the information you will need to have your WEBER product repaired in the unlikely event of a failure or defect. Pursuant to applicable laws, the customer has several rights in case the product is defective. Those rights include supplementary performance or replacement, abatement of the purchasing price, and compensation. These and other statutory rights remain unaffected by this warranty provision. In fact, this warranty grants additional rights to the Owner that are independent from statutory warranty provisions.

WEBER'S LIMITED WARRANTY

WEBER warrants, to the purchaser of the WEBER product (or in the case of a gift or promotional situation, the person for whom it was purchased as a gift or promotional item) ("Owner"), that the WEBER product is free from defects in material and workmanship for the period(s) of time specified below when assembled and operated in accordance with the accompanying Owner's Manual, normal wear and tear excluded. (Note: If you lose or misplace your WEBER Owner's Manual, a replacement is available online at www.weber.com.) WEBER agrees within the framework of this warranty to repair or replace the part that is defective in material or workmanship subject to the limitations, and exclusions listed below. TO THE EXTENT ALLOWABLE BY APPLICABLE LAW, THIS WARRANTY IS EXTENDED ONLY TO THE ORIGINAL PURCHASER AND IS NOT TRANSFERABLE TO SUBSEQUENT OWNERS, EXCEPT IN THE CASE OF GIFTS AND PROMOTIONAL ITEMS AS NOTED ABOVE.

WEBER stands by its products and is happy to provide you with the Warranty described for material defects in the grill or its relevant components, normal wear and tear excepted.

• Normal wear and tear includes cosmetic and other immaterial deterioration that may come with ownership of your grill over time, such as surface rust, dents / scratches, etc.

However, WEBER will honor this Warranty for the grill or its relevant components where damage or dysfunction results from a material defect.

• Material defect includes rust through or burn through of certain parts, or other damage or failure inhibiting your ability to safely / properly use your grill.

OWNER'S RESPONSIBILITIES UNDER THIS WARRANTY

To ensure trouble-free warranty coverage, it is important (but it is not required) that you register your WEBER product online at www.weber.com. Please also retain your original sales receipt and/or invoice. Registering your WEBER product confirms your warranty coverage and provides a direct link between you and WEBER in case we need to contact you. If you have not had time to register your grill before calling for Warranty service, please have the following information available when you do call: Name – Address – Phone Number – Email – Serial Number – Purchase Date – Purchase Dealer – Model – Color – Primary Issue

The above warranty only applies if the Owner takes reasonable care of the WEBER product by following all assembly instructions, usage instructions, and preventative maintenance as outlined in the accompanying Owner's Manual, unless the Owner can prove that the defect or failure is independent of non-compliance with the above mentioned obligations. If you live in a coastal area, or have your product located near a pool, maintenance includes regular washing and rinsing of the exterior surfaces as outlined in the accompanying Owner's Manual.

WARRANTY HANDLING / EXCLUSION OF WARRANTY

If you believe that you have a part which is covered by this Warranty, please contact WEBER Customer Service using the contact information on our website (www.weber.com), or such country-specific website to which Owner may be redirected). WEBER will, upon investigation, repair or replace (at its option) a defective part that is covered by this Warranty. In the event that repair or replacement are not possible, WEBER may choose (at its option) to replace the grill in question with a new grill of equal or greater value. WEBER may ask you to return parts for inspection, shipping charges to be pre-paid by owner. When you contact Customer Service, please have the following information available: Name – Address – Phone Number – Email – Serial Number – Purchase Date – Purchase Dealer – Model – Color – Primary Issue

This WARRANTY lapses if there are damages, deteriorations, discolorations, and/or rust for which WEBER is not responsible caused by:

- Abuse, misuse, alteration, modification, misapplication, vandalism, neglect, improper assembly or installation, and failure to properly perform normal and routine maintenance;
- Insects (such as spiders) and rodents (such as squirrels), including but not limited to damage to burner tubes and/or gas hoses;
- Exposure to salt air and/or chlorine sources such as swimming pools and hot tubs/spas;
- Severe weather conditions such as hail, hurricanes, earthquakes, tsunamis or surges, tornadoes or severe storms.
- Acid rain and other environmental factors.

Using third party parts will not void this Warranty. However, any parts that are used and/or installed on your WEBER product that are not genuine WEBER parts are not covered by this Warranty. In addition, any damages that result from the use and/or installation of parts on your WEBER product that are not genuine WEBER parts are not covered by this Warranty. Any conversion of a gas grill not authorized by WEBER and performed by a WEBER authorized service technician will void this Warranty.

PRODUCT WARRANTY PERIODS

Cookbox:
12 years, no rust through/burn through
(2 years paint excluding fading or discoloration)

Lid assembly:
12 years, no rust through/burn through
(2 years paint excluding fading or discoloration)

Stainless steel burner tubes:
10 years, no rust through/burn through

Stainless steel cooking grates:
10 years, no rust through/burn through

Stainless steel FLAVORIZER BARS:
10 years, no rust through/burn through

Porcelain-enameled cast iron cooking grates:
10 years, no rust through/burn through

WEBER CONNECT Components:
3 years

All remaining parts:
5 years

DISCLAIMERS

APART FROM THE WARRANTY AND DISCLAIMERS AS DESCRIBED IN THIS WARRANTY STATEMENT, THERE ARE EXPLICITLY NO FURTHER WARRANTY OR VOLUNTARY DECLARATIONS OF LIABILITY GIVEN HERE WHICH GO BEYOND THE STATUTORY LIABILITY APPLYING TO WEBER. THE PRESENT WARRANTY STATEMENT ALSO DOES NOT LIMIT OR EXCLUDE SITUATIONS OR CLAIMS WHERE WEBER HAS MANDATORY LIABILITY AS PRESCRIBED BY STATUTE. NO WARRANTIES SHALL APPLY AFTER THE APPLICABLE PERIODS OF THIS WARRANTY. NO OTHER WARRANTIES GIVEN BY ANY PERSON, INCLUDING A DEALER OR RETAILER, WITH RESPECT TO ANY PRODUCT (SUCH AS ANY "EXTENDED WARRANTIES"), SHALL BIND WEBER. THE EXCLUSIVE REMEDY OF THIS WARRANTY IS REPAIR OR REPLACEMENT OF THE PART OR PRODUCT.

IN NO EVENT UNDER THIS WARRANTY SHALL RECOVERY OF ANY KIND BE GREATER THAN THE AMOUNT OF THE PURCHASE PRICE OF THE WEBER PRODUCT SOLD. YOU ASSUME THE RISK AND LIABILITY FOR LOSS, DAMAGE, OR INJURY TO YOU AND YOUR PROPERTY AND/OR TO OTHERS AND THEIR PROPERTY ARISING OUT OF THE MISUSE OR ABUSE OF THE PRODUCT OR FAILURE TO FOLLOW INSTRUCTIONS PROVIDED BY WEBER IN THE ACCOMPANYING OWNER'S MANUAL.

PARTS AND ACCESSORIES REPLACED UNDER THIS WARRANTY ARE WARRANTED ONLY FOR THE BALANCE OF THE ABOVE MENTIONED ORIGINAL WARRANTY PERIOD(S). THIS WARRANTY APPLIES TO PRIVATE SINGLE FAMILY HOME OR APARTMENT USE ONLY AND DOES NOT APPLY TO WEBER GRILLS USED IN COMMERCIAL, COMMUNAL OR MULTI-UNIT SETTINGS SUCH AS RESTAURANTS, HOTELS, RESORTS, OR RENTAL PROPERTIES.

WEBER MAY FROM TIME TO TIME CHANGE THE DESIGN OF ITS PRODUCTS. NOTHING CONTAINED IN THIS WARRANTY SHALL BE CONSTRUED AS OBLIGATING WEBER TO INCORPORATE SUCH DESIGN CHANGES INTO PREVIOUSLY MANUFACTURED PRODUCTS, NOR SHALL SUCH CHANGES BE CONSTRUED AS AN ADMISSION THAT PREVIOUS DESIGNS WERE DEFECTIVE.

**Weber-Stephen Products LLC
Customer Service Center**
1415 S. Roselle Road
Palatine, IL 60067
U.S.A.

For replacement parts, call:
1-800-446-1071

Important Information about LP Gas & Gas Connections

What Is LP Gas?

Liquefied petroleum gas, also called LP, LP gas, liquid propane, or simply propane or butane, is the flammable, petroleum-based product used to fuel your grill. It is a gas at moderate temperatures and pressure when it is not contained. But at moderate pressure inside a container, such as a tank, LP is a liquid. As pressure is released from the tank, the liquid readily vaporizes and becomes gas.

Safe Handling Tips For LP Tanks

- A dented or rusty liquid propane tank may be hazardous and should be checked by your liquid propane supplier. Do not use a liquid propane tank with a damaged valve.
- Although your liquid propane tank may appear to be empty, gas may still be present, and the tank should be transported and stored accordingly.
- The LP tank must be installed, transported, and stored in an upright, secure position. LP tanks should not be dropped or handled roughly.
- Never store or transport the LP tank where temperatures can reach 125° F (51.7° C) (the tank will become too hot to hold by hand).
- Place dust cap on cylinder valve outlet whenever the cylinder is not in use. Only install the type of dust cap on the cylinder valve outlet that is provided with the cylinder valve. Other types of caps or plugs may result in leakage of propane.

LP Tank Requirements

- The tank must be approximately 18 $\frac{1}{4}$ inches (46.35 cm) high and 12 $\frac{1}{2}$ inches (31.1 cm) in diameter with a marked 20 pound (9.07 kg) LP capacity or 47.6 pound (21.6 kg) water capacity as stated by the manufacturer. Other tanks may be acceptable provided they are compatible with the grill retention means (tank scale).
- The tank used must be constructed and marked in accordance with the Specifications for LP gas Cylinders of the U.S. Department of Transportation (D.O.T.); or the Canadian Standard for Cylinders, Spheres and Tubes for Transportation of Dangerous Goods and Commission, CAN/CSA-B339, as applicable.
- Tanks must be provided with a listed OPD (Overfilling Prevention Device) and a Type 1 (CGA 791) tank connection. The tank connection must be compatible with the grill connection.
- The tank must include a collar to protect the tank valve.
- Tanks must have a D.O.T. certification (A), and a testing date (B) that is within five years of current use.

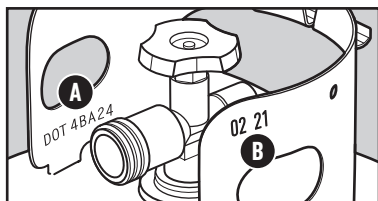

What is a Regulator?

Your gas grill is equipped with a pressure regulator, which is a device to control and maintain uniform gas pressure as gas is released from the LP tank.

Regulator Requirements

- The regulator and hose assembly supplied with this grill must be used. This regulator has a flow limiting device built into the unit that will restrict the flow of gas in the event that a leak is detected.
- Replacement regulator and hose assemblies must be as specified by Weber-Stephen Products LLC (UL-listed Type 1 (CGA 791) tank connection device as described in the latest edition of ANSI Z21.81).

LP Tank Installation

Installation Location

The tank is hung onto the tank hook which is located inside the cabinet. The shape of the collar assembly (the metal protective ring around the tank valve) determines one of two directions in which the tank will correctly hang on the tank hook (A).

Inspect the Tank

- 1) Confirm that the tank valve is fully closed. Close by turning valve clockwise.
- 2) Inspect the tank valve, including the internal rubber seal for damage or debris (B). If damaged, return tank to local retailer.
- 3) Confirm that the tank valve is the proper mating type for the regulator (C).

Install The Tank

Check that all burner control knobs are in the off \odot position. Check by pushing in and turning knobs clockwise.

The LP tank will hang on the tank hook mounted on the inside panel.

- 1) Locate the metal hose retention clip on the regulator hose. Secure the clip into the slot on the underside of the tank hook bracket (D).
- 2) Lift tank into position onto the tank hook.
- 3) Screw the regulator coupling onto the tank valve, turning clockwise. Hand-tighten only. Using a wrench could damage the regulator coupling and could cause a leak. Proceed to "CHECKING FOR GAS LEAKS."

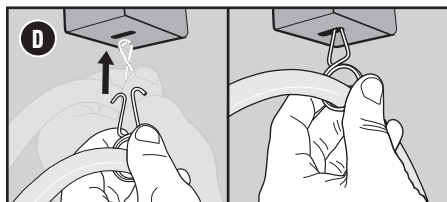
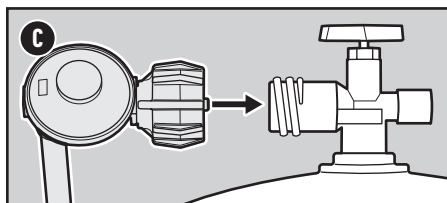
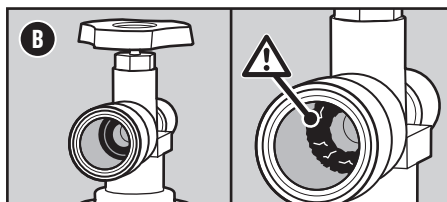
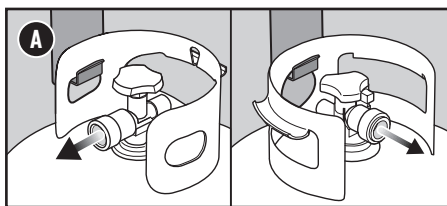

Refilling or Replacing an LP Tank

Removal of the LP Tank

- 1) Make sure the grill is off and cool.
- 2) Confirm that the tank valve is fully closed. Close by turning valve clockwise.
- 3) Unscrew regulator coupling by turning counterclockwise by hand.
- 4) Lift tank off tank hook.

⚠ **DANGER:** Do not line the slide-out grease tray or cookbox with aluminum foil.

⚠ **DANGER:** Check the slide-out grease tray and catch pan for grease build-up before each use. Remove excess grease to avoid a grease fire.

⚠ **WARNING:** Use caution when removing catch pan and disposing of hot grease.

⚠ **WARNING:** Use heat-resistant barbecue mitts or gloves when operating grill.

⚠ **WARNING:** Grill brushes should be checked for loose bristles and excessive wear on a regular basis. Replace brush if any loose bristles are found on cooking grates or brush. WEBER recommends purchasing a new stainless steel bristle grill brush at the beginning of every spring.

⚠ **WARNING:** Keep ventilation openings around tank clear and free of debris.

⚠ **WARNING:** The hose must be secured with the Hose Retention Clip. Failure to do so could cause damage to the hose resulting in a fire or explosion which can cause serious bodily injury or death, and damage to property.

⚠ **WARNING:** Keep any electrical supply cord and the fuel supply cord away from heated surfaces.



Leak Checking

What is a Leak Check?

Once the LP tank is properly installed, it is necessary to perform a leak check. A leak check is a reliable way to verify that gas is not escaping after you connect the tank. The fuel system in your grill features factory-made connections that have been thoroughly checked for gas leaks and the burners have been flame-tested. WEBER recommends performing a thorough leak check after assembly, as well as annually. The following fittings should be tested:

- Where the regulator connects to the tank.
- Where the gas hose connects to the bulkhead.
- Where the bulkhead connects to the corrugated gas line.

Checking for Gas Leaks

- 1) Wet fittings (A) with a soap and water solution, using a spray bottle, brush, or rag. You can make your own soap and water solution by mixing 20% liquid soap with 80% water; or, you can purchase leak check solution in the plumbing section of any hardware store.
- 2) Slowly open gas supply by turning tank valve counterclockwise while checking for bubbles.
- 3) If bubbles appear there is a leak:
 - a) If the leak is at the cylinder (B), turn off the gas. **DO NOT OPERATE THE GRILL.** Disconnect the tank and return the tank to your local retailer.
 - b) If the leak is at the regulator (C), turn off the gas. **NEVER ATTEMPT TO TIGHTEN THE REGULATOR WITH TANK VALVE OPEN. DO NOT OPERATE THE GRILL.** Contact the Customer Service Representative in your area using the contact information on our website.
 - c) If the leak is at any fittings indicated in illustration (D), re-tighten fitting with a wrench and recheck for leaks with soap and water solution. If leak persists, turn off the gas. **DO NOT OPERATE THE GRILL.**
 - d) If the leak is at any fittings indicated in illustration (E), turn off the gas. **DO NOT OPERATE THE GRILL.**

If a leak is present, contact the Customer Service Representative in your area using the contact information on our website.

- a) Turn gas supply off at the tank and rinse connections with water.

NOTE: Since some leak test solutions, including soap and water, may be slightly corrosive, all connections should be rinsed with water after checking for leaks.

Additional Leak Check Precautions

The following fittings should be tested for gas leaks each time a tank is refilled and reinstalled:

- At the cylinder (B) and at the regulator (C).

Follow the instructions for "Checking for Gas Leaks".

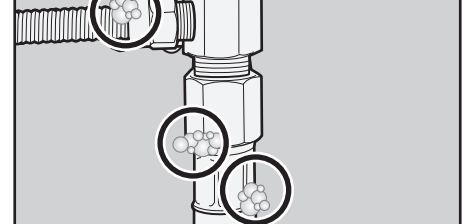
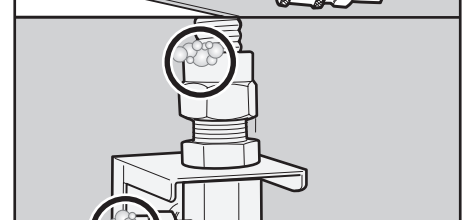
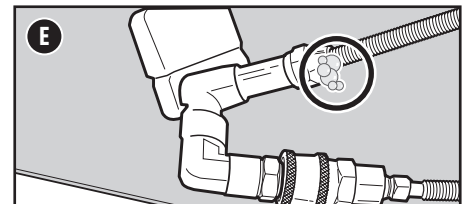
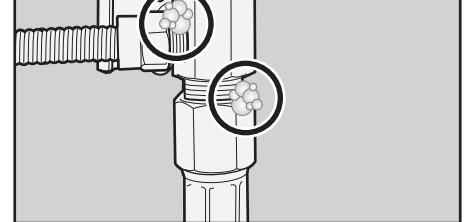
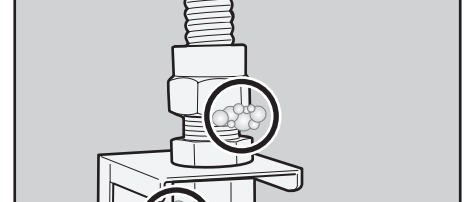
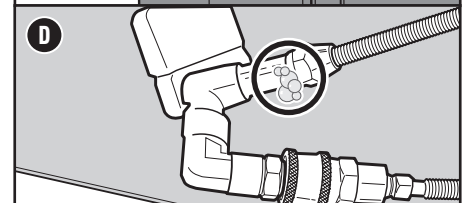
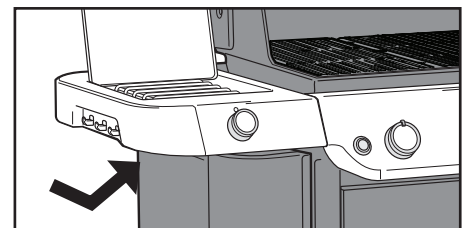
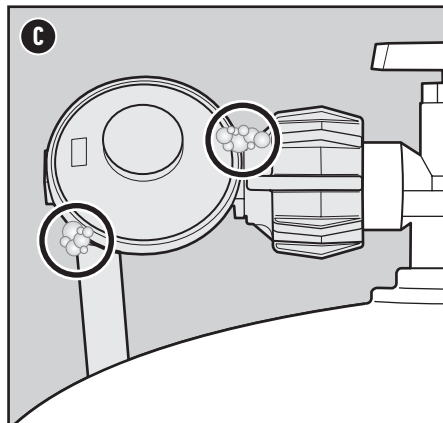
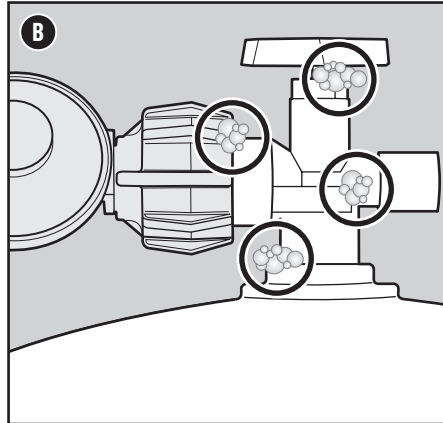
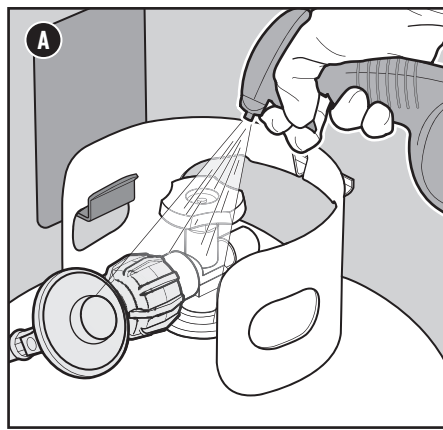

⚠ DANGER: Do not use a flame to check for gas leaks. Be sure there are no sparks or open flames in the area while you check for leaks.

⚠ DANGER: Leaking gas may cause a fire or explosion.

⚠ DANGER: Do not operate the grill if there is a gas leak present.

⚠ DANGER: If you see, smell, or hear the hiss of gas escaping from the liquid propane tank:

- 1) Move away from liquid propane tank.
- 2) Do not attempt to correct the problem yourself.
- 3) Call your fire department.

⚠ DANGER: Always close the tank valve before disconnecting the regulator. Do not attempt to disconnect the gas regulator and hose assembly or any gas fitting while this grill is in operation.

⚠ DANGER: Do not store a spare LP tank under or near this grill. Never fill the tank beyond 80% full. Failure to follow these statements exactly may result in a fire causing death or serious injury.

Inspect the Hose

Routine inspection of the hose is necessary.

- 1) Confirm that the grill is off and cool.
- 2) Check hose for any signs of cracking, abrasions, or cuts (A). If the hose is found to be damaged in any way, do not use the grill.

⚠ WARNING: If the hose is found to be damaged in any way, do not use the grill. Replace using only WEBER authorized replacement hose.

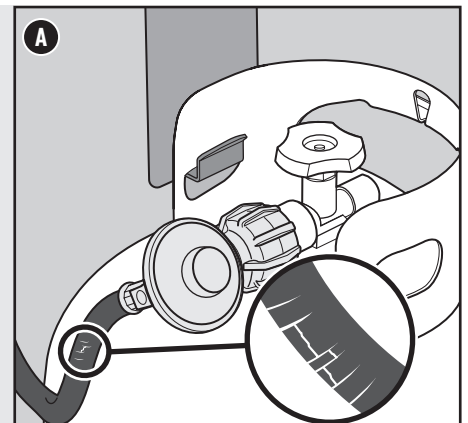



Igniting the Grill

Using the Electronic Ignition System to Ignite the Grill

Each control knob operates an individual burner, and each burner ignites independently. Ignite the burners starting from left to right. All burners should be lit for preheating, however, all burners do not have to be lit while grilling.

- 1) Open the grill lid (A).
- 2) Check that all burner control knobs are in the off  position. Check by pushing in and turning knobs clockwise.

Note: It is important that all burner control knobs are in the off  position before turning on the LP tank. If they are not, the flow limiting device built into the regulator will activate, limiting the flow of gas from the LP tank.
- 3) Turn the LP tank on by slowly turning the tank valve counterclockwise; wait 60 seconds (B).

Note: It is important that the LP tank is turned on slowly. If it is opened too quickly, the flow limiting device built into the regulator will activate, limiting the flow of gas from the LP tank.
- 4) Begin with the burner furthest to the left. Push the burner control knob in and turn it counterclockwise to the start/high  position (C).
- 5) Push and hold the electronic ignition button (D). You will hear it ticking.
- 6) Check that the burner is lit by looking through the cooking grates and through the half-circle cutout in the FLAVORIZER bar.
- 7) If the burner does not ignite, turn burner control knob to the off  position and wait five minutes to allow the gas to clear before attempting to light the burner again.
- 8) If the burner ignites, repeat steps 4 through 6 to light the remaining burners.

Should the burners fail to ignite using the electronic ignition, refer to the TROUBLESHOOTING section. There you will find instructions on igniting the grill with a match to help determine the exact problem.

Preheat the Grill

Preheating the grill is critical to successful grilling. Preheating helps to prevent food from sticking to the grate and gets the grate hot enough to sear properly. It also burns off residue of a previously cooked meal.

- 1) Open the grill lid.
- 2) Ignite your grill according to the ignition instructions in this Owner's Manual.
- 3) Close lid.
- 4) Preheat the grill with all burners on the start/high  position for 15 minutes (C).

To Extinguish Burners

- 1) Push each burner control knob in and then turn clockwise all the way to the off  position.
- 2) Turn gas supply off at the LP tank.

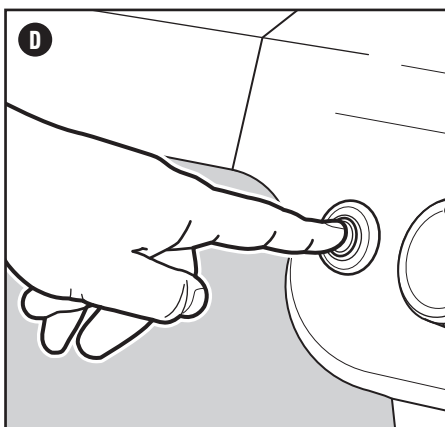
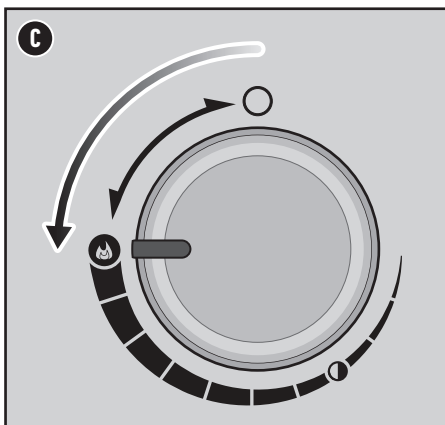
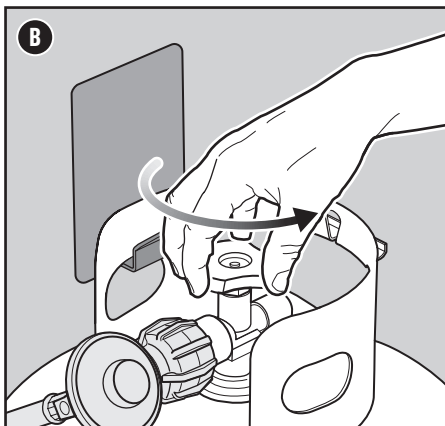
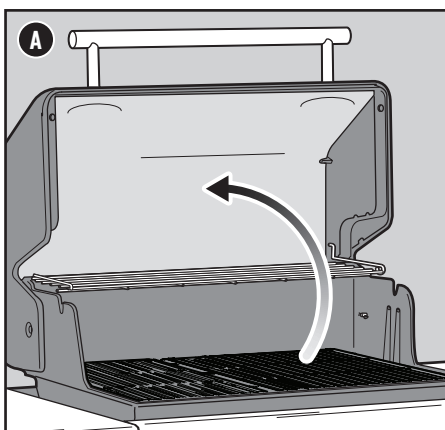



Using the sear zone

This feature is only available on select models.

Searing is a direct grilling technique used on meats, such as steak, poultry parts, fish and chops. Searing browns the surface of the food at a high temperature. By searing both sides of the meat, you caramelize the food surface, creating a more desirable flavor.

Ignition of the sear burner is the same as ignition of a main burner, each burner ignites independently.

- 1) Open the lid and ignite all of the burners, including the sear burner. Refer to IGNITING THE GRILL.
- 2) Preheat the grill with the lid closed and with all burners on the start/high  position for 15 minutes.
- 3) After preheating, leave the sear burner control knob and the adjacent burner control knobs in the start/high  position (E). The sear burner works in tandem with adjacent burners (F). The remaining burner(s) can be turned to off or low.
- 4) Place meat directly over the sear zone and close lid. Sear each side anywhere from one to four minutes (G), depending on the type and thickness of meat. Once searing is complete, the meat can be moved to moderate heat over and cooked to your desired doneness.

Note: Always cook with the lid closed to achieve maximum heat and to avoid flare-ups.

As you gain experience using the sear zone we encourage you to experiment with different searing times to find the results that work best for your taste.

To Extinguish Burners

- 1) Push each burner control knob in and then turn clockwise all the way to the off  position.
- 2) Turn gas supply off.

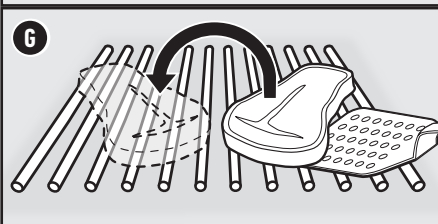
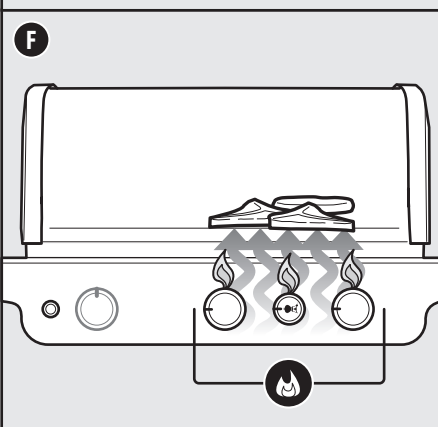
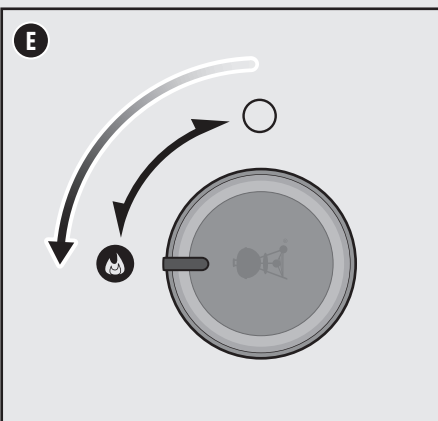





- ⚠ **WARNING:** Open lid during ignition.
- ⚠ **WARNING:** Do not lean over open grill while igniting or cooking.
- ⚠ **WARNING:** Each burner must be ignited individually by pushing the electronic ignition button.
- ⚠ **WARNING:** If ignition does not occur within four seconds of attempting to light the first burner, turn the burner control knob to the off position. Wait five minutes to allow accumulated gas to dissipate, and then repeat the lighting procedure.

Igniting the Side Burner

Using the Electronic Ignition to Ignite the Side Burner

This feature is only available on select models.

If one or more of the main burners on your grill are already lit and you would like to ignite the side burner, skip to step 3. If none of the main burners are lit and you are only using the side burner, start with step 1.

- 1) Check that the side burner control knob is in the off  position. Check by pushing in and turning knob clockwise (A). Also check that all main burner control knobs are in the off  position.
Note: It is important that all burner control knobs are in the off  position before turning on the LP tank. If they are not, the flow limiting device built into the regulator will activate, limiting the flow of gas from the LP tank.
- 2) Turn the LP tank on by slowly turning the tank valve counterclockwise; wait 60 seconds.
Note: It is important that the LP tank is turned on slowly. If it is opened too quickly, the flow limiting device built into the regulator will activate, limiting the flow of gas from the LP tank.
- 3) Open the side burner lid (B).
- 4) Push in and turn side burner control knob counterclockwise to start/high  position (C).
- 5) Push and hold in the electronic ignition button (D). You will hear the igniter clicking. Check that the side burner is lit. The side burner flame may be difficult to see on a bright sunny day.
- 6) Once side burner is ignited, continue turning the knob counterclockwise until you reach the desired position.
- 7) If the side burner does not ignite within 4 seconds, turn side burner control knob to the off  position and wait five minutes to allow the gas to clear before attempting to light the burner again.

Should the side burner fail to ignite using the electronic ignition, refer to the TROUBLESHOOTING section. There you will find instructions on igniting the side burner with a match to help determine the exact problem.

To Extinguish Side Burner

- 1) Push side burner control knob in and then turn clockwise all the way to the off  position.
- 2) Turn gas supply off at the LP tank.

⚠ WARNING: Open side burner lid during ignition.

⚠ WARNING: Do not lean over side burner while igniting or cooking.

⚠ WARNING: If ignition does not occur within four seconds of attempting to light the side burner, turn the burner control knob to the off position. Wait five minutes to allow accumulated gas to dissipate, and then repeat the lighting procedure.

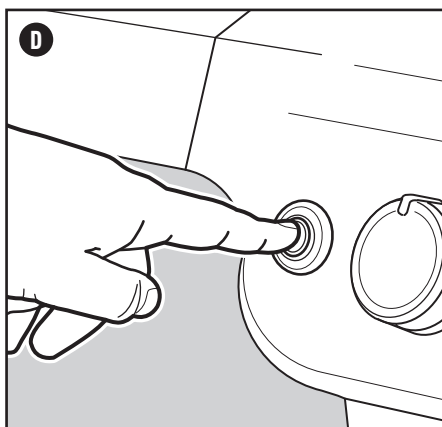
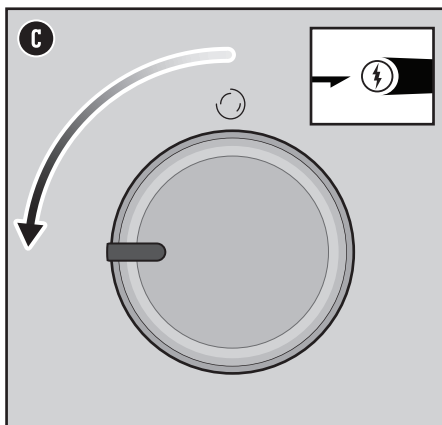
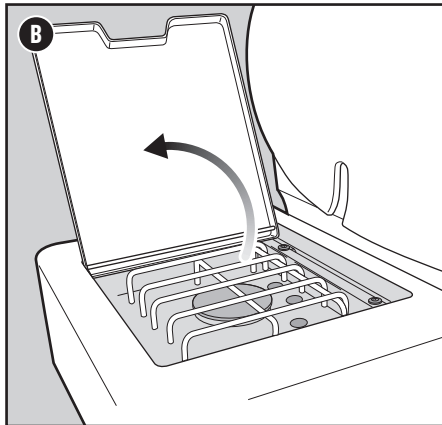
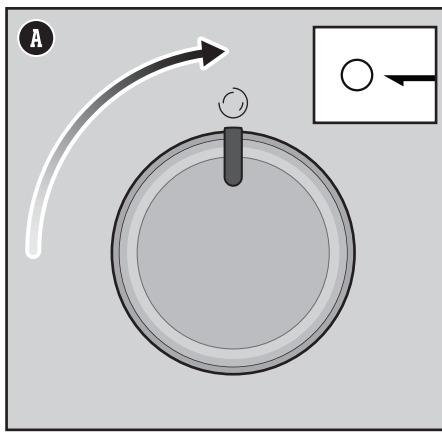

Cleaning and Maintenance

Cleaning the Inside of the Grill

Over time, the performance of your grill can diminish if it has not been maintained properly. Low temperatures, uneven heat, and food sticking to cooking grates are all signs that cleaning and maintenance are overdue. When your grill is off and cool, start by cleaning the inside, from the top down. A thorough cleaning is recommended at least twice a year. Consistent use may require quarterly cleanings.

Cleaning the Lid

From time to time you may notice "paint-like" flakes on the inside of the lid. During use, grease and smoke vapors slowly change into carbon and deposit on the inside of your lid. These deposits will eventually peel, and look very similar to paint. These deposits are non-toxic, but the flakes could fall onto your food if you do not clean the lid regularly.

- 1) Brush the carbonized grease from the inside of the lid with a stainless steel bristle grill brush (A). To minimize further build-up, the inside of the lid can be wiped with a paper towel after grilling while the grill is still warm (not hot).

Cleaning the Cooking Grates

Cleaned grates will prevent your next meal from sticking. If you are cleaning your cooking grates regularly, the debris on your grates will be minimal.

- 1) With grates installed, brush the debris off your cooking grate with a stainless steel bristle grill brush (B).
- 2) Take the grates out and set aside.

Cleaning the FLAVORIZER BARS

FLAVORIZER BARS catch drippings that smoke and sizzle, adding flavor to your food. Any drippings that are not vaporized by the FLAVORIZER BARS are funneled away from the burners. This helps prevent flare-ups inside of your grill, and protects the burners from getting clogged.

- 1) Scrape the FLAVORIZER BARS with a plastic scraper (C).
- 2) If necessary, brush the FLAVORIZER BARS with a stainless steel bristle grill brush.
- 3) Remove FLAVORIZER BARS and set aside.

Cleaning the Burners

Two areas on the burners that are key to optimum performance are the ports (small raised openings running along the length of the burners) and the spider/insect screens on the ends of the burner. Keeping these areas clean is essential for safe operation.

Cleaning the Burner Ports

- 1) Use a clean stainless steel bristle grill brush to clean the outside of the burners by brushing across the top of the burner ports (D).
- 2) When cleaning the burners, avoid damaging the ignition electrode by carefully brushing around it.

Cleaning the Spider Screens

- 1) Locate the ends of the burners on the underside of the control panel where they meet the valves.
- 2) Clean the spider/insect screens on each of the burners using a soft bristle brush (E).

Cleaning the Heat Deflectors

Located under the burners, the heat deflectors distribute heat evenly throughout the cookbox while cooking. Keeping heat deflectors clean will enhance the cooking performance of your grill.

- 1) Scrape the heat deflectors with a plastic scraper.
- 2) If necessary, brush the heat deflectors with a stainless steel bristle grill brush.
- 3) Remove heat deflectors and set aside.

Cleaning the Cookbox

Look inside the cookbox for any grease accumulation or leftover food particles. Excessive accumulation can cause a fire.

- 1) Use a plastic scraper to scrape debris off the sides and bottom of the grill into the opening in bottom of the cookbox. This opening leads debris into the slide-out grease tray.

Cleaning the Grease Management System

The grease management system consists of an angled slide-out grease tray and a catch pan. These components were designed to be easily removed, cleaned, and replaced; an essential step every time you prepare to grill.

Cleaning the Outside of the Grill

The outside of your grill may include stainless steel, porcelain-enameled, and plastic surfaces. WEBER recommends the following methods based on the surface type.

Cleaning Stainless Steel Surfaces

Clean stainless steel using a non-toxic, non-abrasive stainless steel cleaner or polish designed for use on outdoor products and grills. Use a microfiber cloth to clean in the direction of the grain of the stainless steel. Do not use paper towels.

Note: Do not risk scratching your stainless steel with abrasive pastes. Pastes do not clean or polish. They will change the color of the metal by removing the top chromium oxide film coating.

Cleaning Painted, Porcelain-Enameled Surfaces and Plastic Components

Clean painted, porcelain-enameled and plastic components with warm soapy water, and paper towels or cloth. After wiping down the surfaces, rinse and dry thoroughly.

Cleaning the Outside of Grills that are in Unique Environments

If your grill is subject to a particularly harsh environment, you will want to clean the outside more often. Acid rain, pool chemicals, and salt water can cause surface rusting to appear. Wipe down the outside of your grill with warm soapy water. Follow up with a rinse and thorough drying. Additionally, you may want to apply a stainless steel cleaner weekly to prevent surface rust.

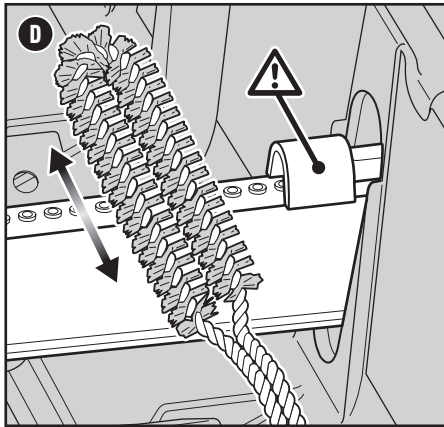
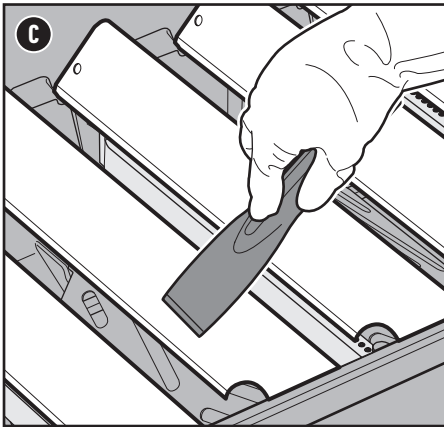
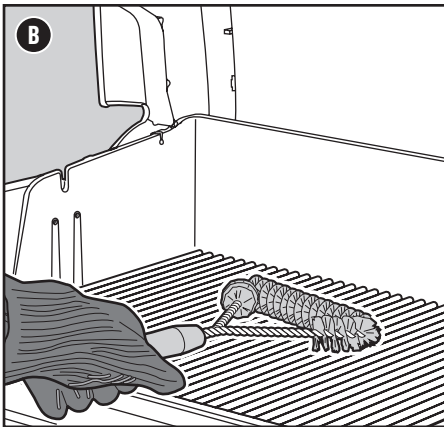
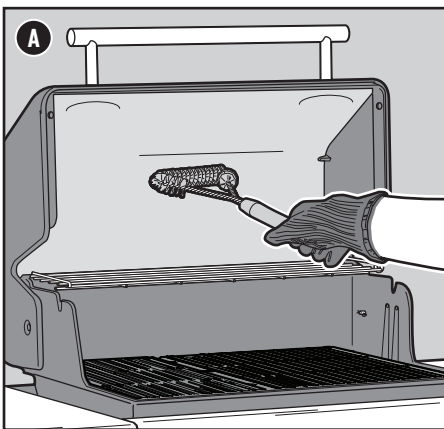

Proper Burner Flame Pattern

The burners in your grill were factory set for the correct air and gas mixture. When the burners are performing correctly, you will see a specific flame pattern. The tips may occasionally flicker yellow (A), with a descending light blue (B) to dark blue flame (C).

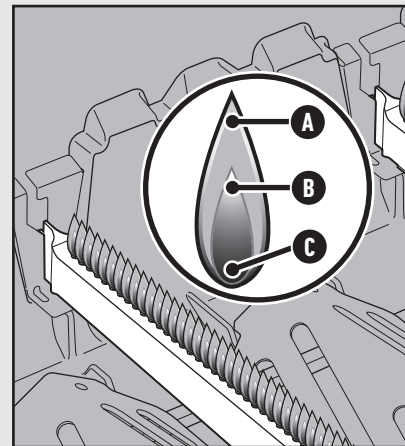

Spider Screens

The combustion air openings of the burners (D) are fitted with stainless steel screens to prevent spiders and other insects from spinning webs and building nests inside the burners. Additionally, dust and debris can accumulate on the outside of the spider/insect screen and obstruct the oxygen flow to the burners.

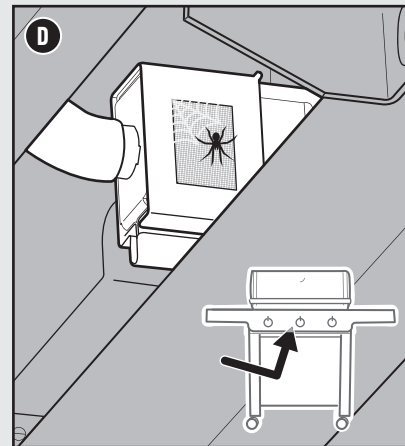

⚠ WARNING: Do not attempt to make any repair to gas carrying, gas burning, ignition components or structural components without contacting Weber-Stephen Products LLC, Customer Service Department.

⚠ CAUTION: The burner tube openings must be positioned properly over the valve orifices.

⚠ WARNING: Turn your grill off and wait for it to cool before thoroughly cleaning.

⚠ WARNING: Over time, the development of rough surfaces can form on the FLAVORIZER BARS. Wearing gloves is recommended when handling. Do not clean FLAVORIZER BARS or cooking grates in a sink, dishwasher, or self-cleaning oven.

⚠ WARNING: When cleaning the burners, never use a brush that has already been used to clean the cooking grates. Never put sharp objects into the burner port holes.

⚠ CAUTION: Do not place any grill components onto the side tables as they may scratch the paint or stainless steel surfaces.

⚠ CAUTION: Do not use any of the following to clean your grill: abrasive stainless steel polishes or paints, cleaners that contain acid, mineral spirits or xylene, oven cleaner, abrasive cleansers (kitchen cleansers), or abrasive cleaning pads.

REPLACEMENT PARTS

To obtain replacement parts, contact the local retailer in your area or log onto weber.com.

MAIN BURNER(S) or SIDE BURNER WILL NOT IGNITE

SYMPTOM

- Main burners or side burner do(es) not ignite when following the electronic ignition instructions in the “Operation” section of this owner’s manual.

CAUSE

There is a problem with gas flow.

SOLUTION

If any burner does not ignite, the first step is to determine if there is gas flowing to the burner(s). To check this, follow the instructions below for “Lighting Your Grill with a Match.”

If **match lighting IS NOT successful**, follow the instructions for disconnecting and reconnecting the LP tank..

There is a problem with the electronic ignition system.

If any burner does not ignite, the first step is to determine if there is gas flowing to the burner(s). To check this, follow the instructions below for “Lighting Your Grill with a Match.”

If **match lighting IS successful**, check the condition of the battery and check the wire connections of the Electronic Ignition System.

Lighting Your Grill with a Match

Using a Match to Determine if there is Gas Flow to the Main Burners

- 1) Open the grill lid.
- 2) Check that all burner control knobs (including side burner control knob) are in the off \bigcirc position. Check by pushing in and turning knobs clockwise.
Note: It is important that all burner control knobs are in the off \bigcirc position before turning on the LP tank. If they are not, the flow limiting device built into the regulator will activate, limiting the flow of gas from the LP tank.
- 3) Turn the LP tank on by slowly turning the tank valve counterclockwise; wait 60 seconds.
Note: It is important that the LP tank is turned on slowly. If it is opened too quickly, the flow limiting device built into the regulator will activate, limiting the flow of gas from the LP tank.
- 4) Begin with the burner furthest to the left. Put match in the matchstick holder and strike match. (Matchstick holder is located under left side table.) Insert lit match down through the cooking grates, past the FLAVORIZER bars and next to the burner (A).
- 5) Push the burner control knob in and slowly turn it counterclockwise toward the start/high \bullet position.
- 6) Check that the burner is lit by looking through the cooking grates and through the cutout in the FLAVORIZER bar.
- 7) If the burner does not ignite within 4 seconds, turn burner control knob to the off \bigcirc position and wait five minutes to allow the gas to clear before attempting to light the burner again.
- 8) If the burner ignites, the problem lies in the ignition system. Check the condition of the battery and check the wire connections of the Electronic Ignition System.
- 9) Replace the matchstick holder by hanging underneath left side table (B).

Using a Match to Determine if there is Gas Flow to the Side Burner

This feature is only available on select models.

- 1) Open the side burner lid.
- 2) Check that the side burner control knob is in the off \bigcirc position. Check by pushing in and turning knob clockwise. Also check that all main burner control knobs are in the off \bigcirc position.
Note: It is important that all burner control knobs are in the off \bigcirc position before turning on the LP tank. If they are not, the flow limiting device built into the regulator will activate, limiting the flow of gas from the LP tank.
- 3) Turn the LP tank on by slowly turning the tank valve counterclockwise; wait 60 seconds.
Note: It is important that the LP tank is turned on slowly. If it is opened too quickly, the flow limiting device built into the regulator will activate, limiting the flow of gas from the LP tank.
- 4) Put match in the matchstick holder and strike match. (Matchstick holder is located under left side table.) Hold lit match by the side burner (C).
- 5) Push the side burner control knob in and slowly turn it counterclockwise toward the start/high \bullet position.
- 6) Check that the side burner is lit. The side burner flame may be difficult to see on a bright sunny day.
- 7) If the side burner does not ignite within 4 seconds, turn side burner control knob to the off \bigcirc position and wait five minutes to allow the gas to clear before attempting to light the burner again.
- 8) If the burner ignites, the problem lies in the ignition system. Check the condition of the battery and check the wire connections of the Electronic Ignition System.

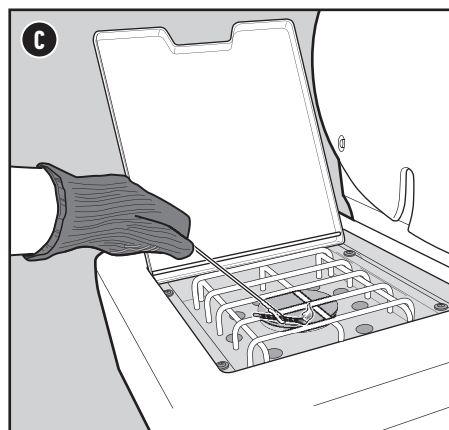
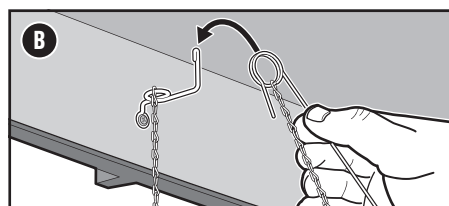
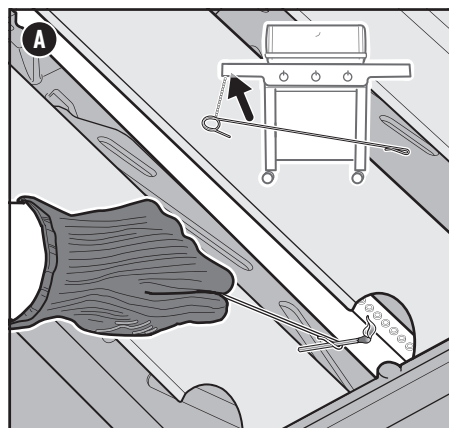

Model: GEN1

PROBLEMS? QUESTIONS? Do Not Return Product to the Store. We Can Help.

If you have questions about the assembly, use, or maintenance of your grill or need replacement parts, please contact Weber Customer Service. The serial number and model number can be found on the cover of your owner’s manual and will be necessary for all service calls.

U.S.:

1-800-446-1071

Canada:

1-800-446-1071

Mexico:

01 800 0093237

CALL CUSTOMER SERVICE

If you are still experiencing any problems, contact the Customer Service Representative in your area using the contact information on weber.com.