

This Owner's Manual is provided and hosted by [Appliance Factory Parts](#).



Broil King 956-97 Owner's Manual

[Shop genuine replacement parts for Broil King 956-97](#)



[Find Your Broil King Grill Parts - Select From 1350 Models](#)

----- Manual continues below part list -----

Available Replacement Parts for Broil King 956-97

03200	spark generator; Bmstr, DCS, Ducane
14625	warming rack universal, 15 x 6.5
11219	CI COOKING GRID - 50M BTU
18434	INFINITY BURNER T501
10892-8NG	WHEEL 8 INCH GREY WALL
03230	spark generator; Ducane
18488	FLAV-R-WAVE - 50,000 BTU STAINLESS
10342-T301	IGNITOR ELECTRODE ASSEMBLY 8 BURNER 1993
18013	LARGE PROBE HEAT INDICATOR
10184-K581	SHELF SUPPORT LFT BLK
10184-K591	SHELF SUPPORT RH BLK
10184-R19	TANK RETAINER-PEDESTAL-NEW
10225-T10	GRID PORCELAIN S/B
10393-K40	SIDE BURNER COVER 1.86
10081-BK630	NAMEPLATE HI BROIL KING BLACK ZINC
10240-15	HINGE PIN SIDE SHELF DROP DOWN
S21237	HINGE PIN SPACER
10110-91	TUBE R/B ASSY COMPR FITTING
10086-R52S	DECO PANEL SS 3VSB
10892-15	CASTER 2 1/2 INCH WHEEL KNURLED
S15171	AXLE PLTD 3/8x18 9/16 PED +
S21124	SCREW PHCP #8 X 12 +
PB20-60A	S/B LID HANDLE WAGON ENCLOSER+ W/SCREWS
10390-E10	BURNER SIDE 10BTU W/ELEC #8 +
10342-T14	WIRE ELECTRODE S/B FLAT/ROUND+
10393-R50	SIDE BURNER BODY 2002 +
10239-7	HANDLE GASKET TRIANGULAR 1/8
50416	SMALL DRIP PAN - 10 PACK
02342	control knob; universal
10184-R80	RADIATION SHIELD RAW

30260130	SHELF SIDE REV A +
10472-k40	KNOB ROTARY IGNITOR #B
80012	regulator and hose READ ADD. INFO
10958-E71	PEDESTAL RESIN BASE LRG +
10111-K45	HOSE 3/8 INCH ASSEMBLY NG 10 FOOT +
Y-11990	NUT HEX BRASS 3/8 27 RB LINE

Broil King®

REDDI-BILT BARBECUES

ASSEMBLY MANUAL & PARTS LIST

MANUEL DE MONTAGE & LISTE DE PIÈCES



Broil King®

REGAL 20
956-24
956-27



Broil King®

REGAL 40
956-44
956-47

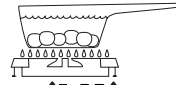

Broil King®

SOVEREIGN 70
956-74
956-77



Broil King®

SOVEREIGN 90
956-94
956-97
956-94S
956-97S

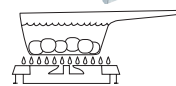

RETAIN FOR FUTURE REFERENCE

VEUILLEZ CONSERVER POUR REFERENCE ULTERIEURE

Onward
SINCE 1906
MANUFACTURING COMPANY
585 KUMPF DRIVE LIMITED
WATERLOO, ONTARIO, CANADA
N2V 1K3

10084-K46 Rev. E 03/04

1

(2)

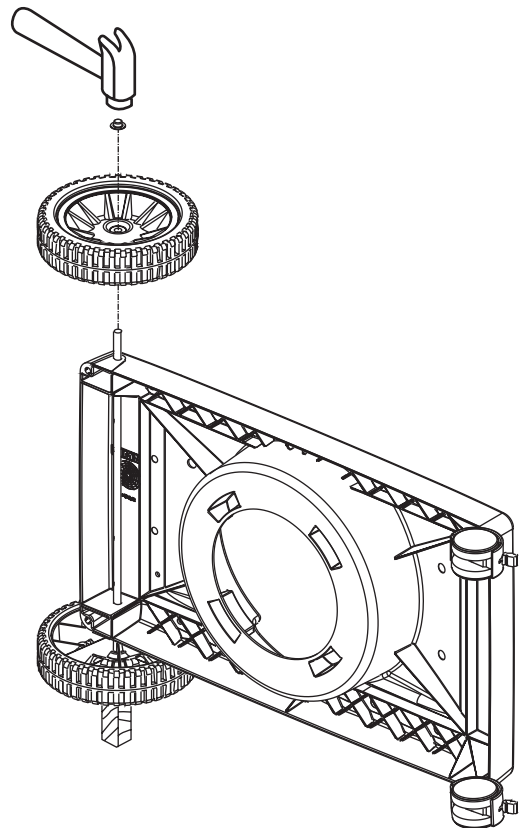
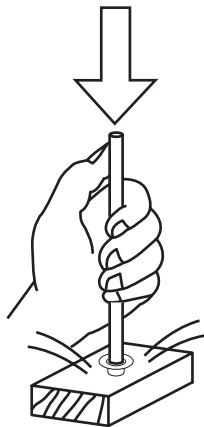
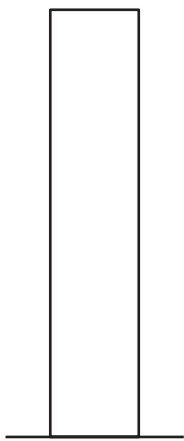
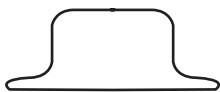
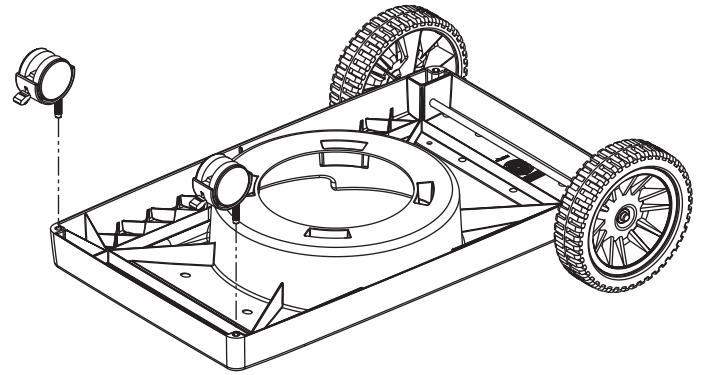
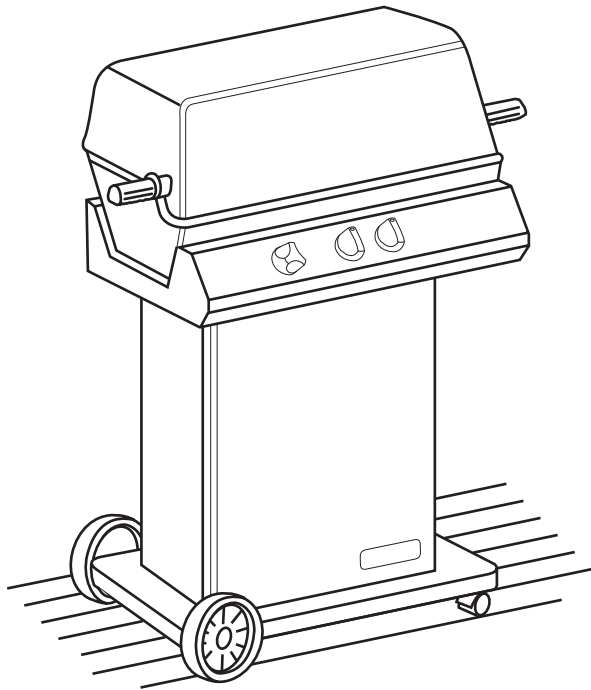

2

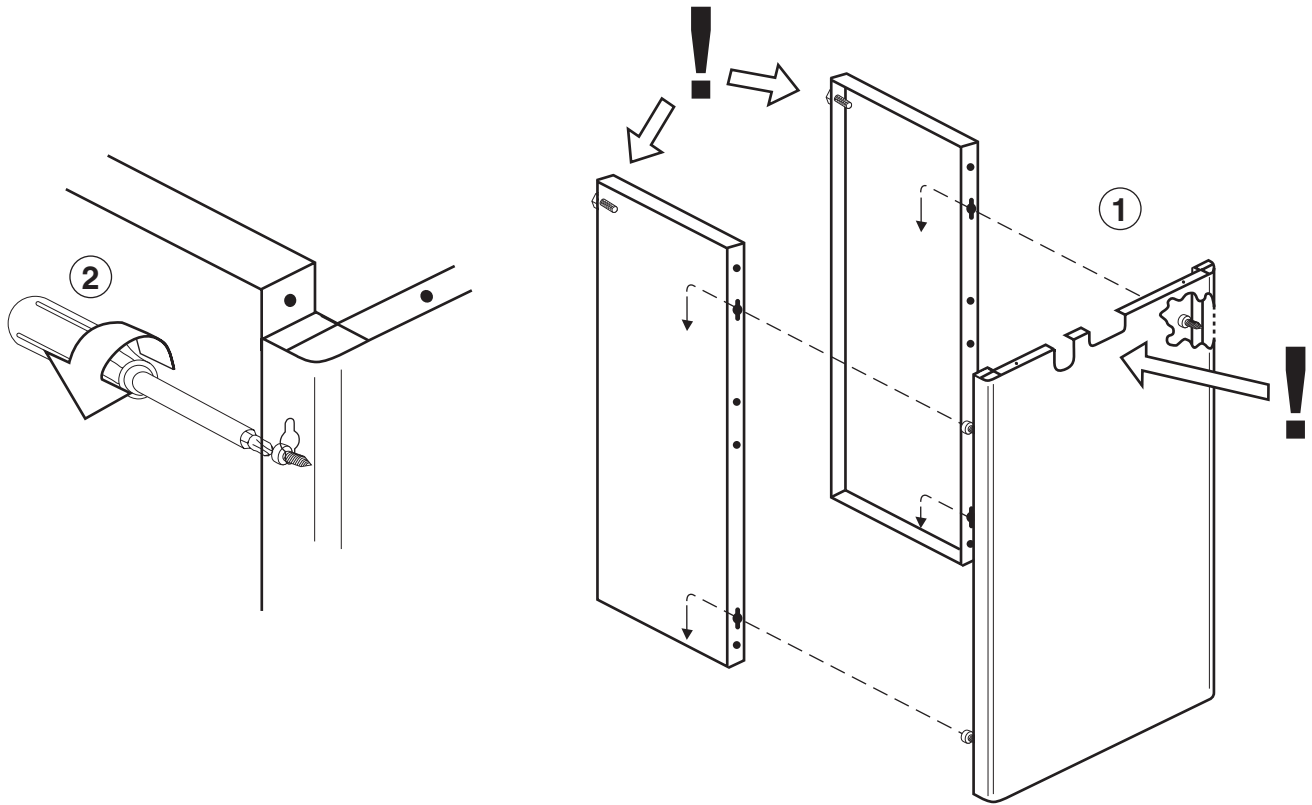

3

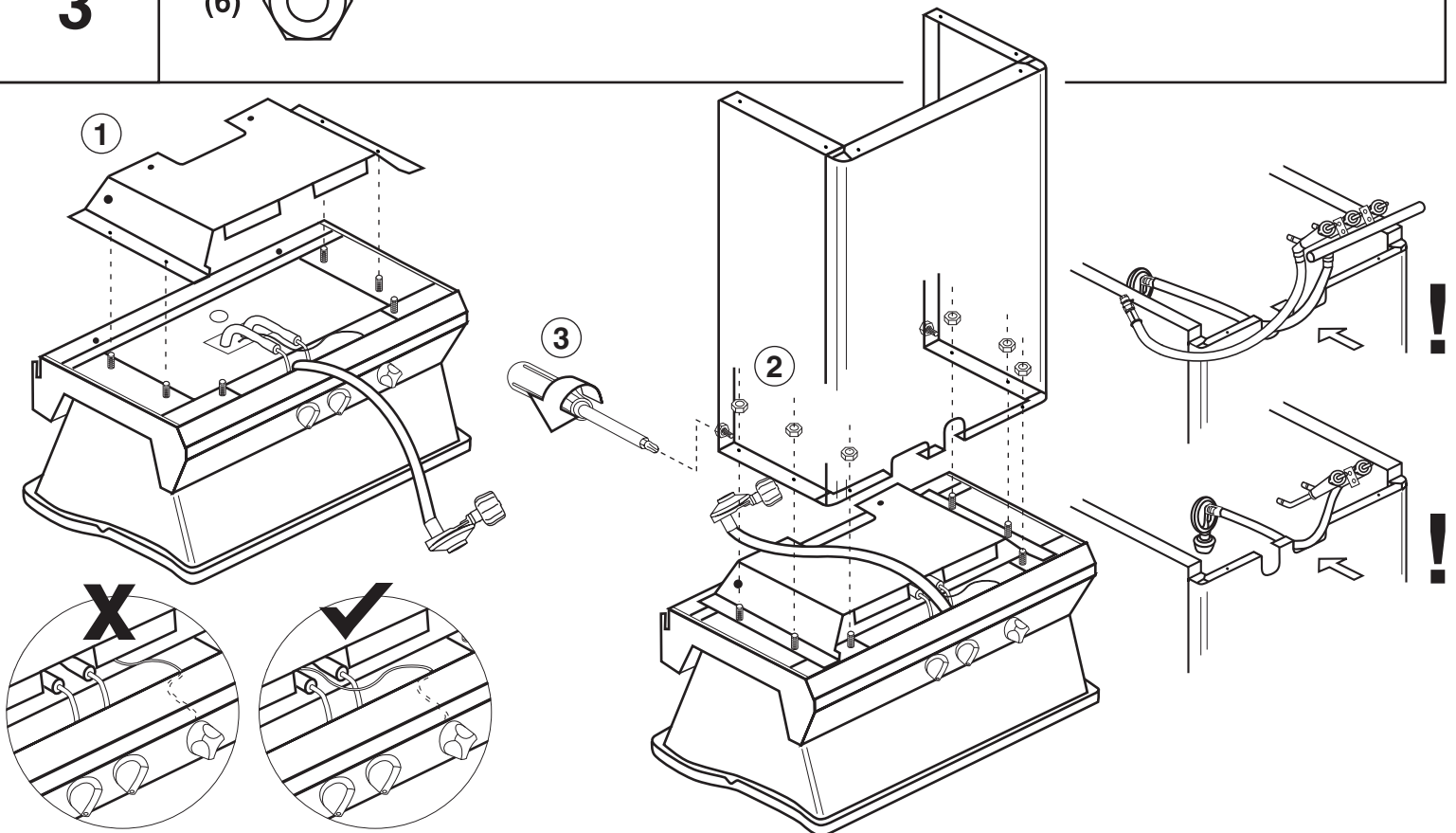

4

(8)



(8)

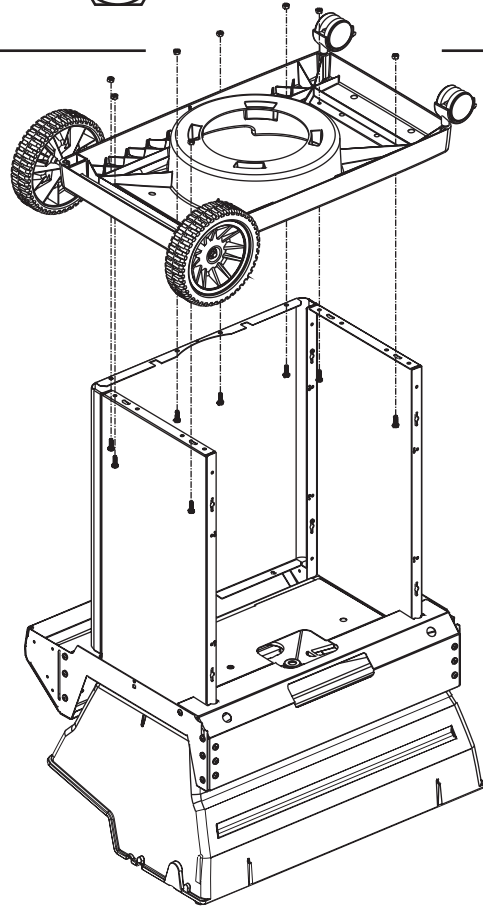

5

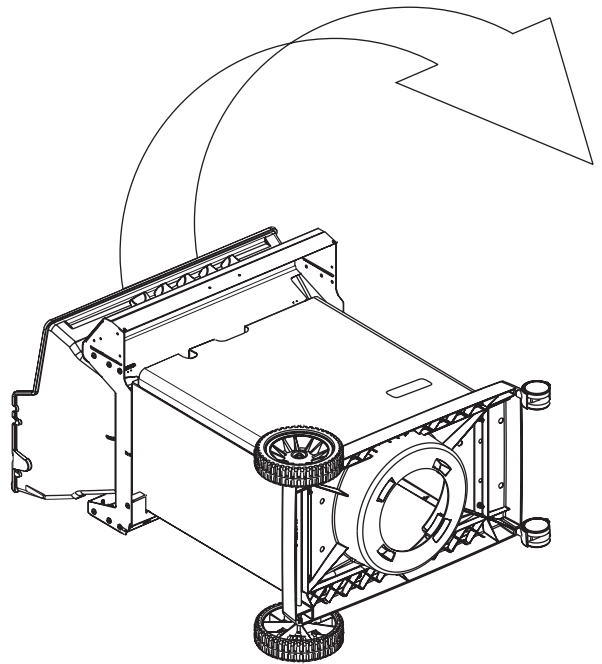
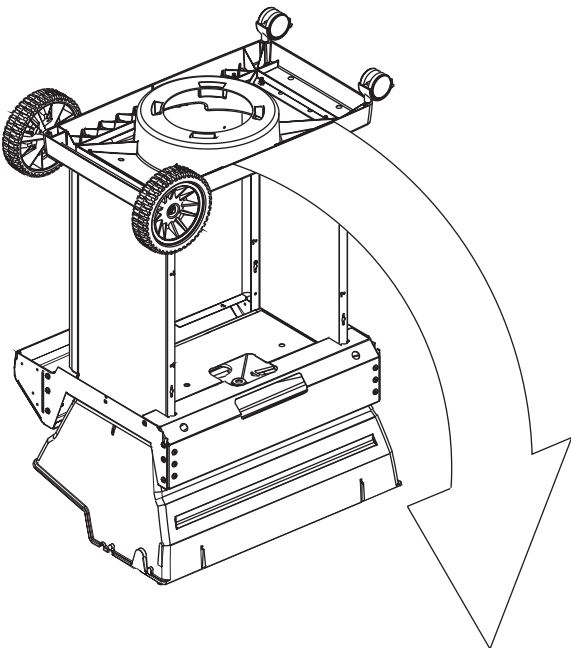

6

(2) 

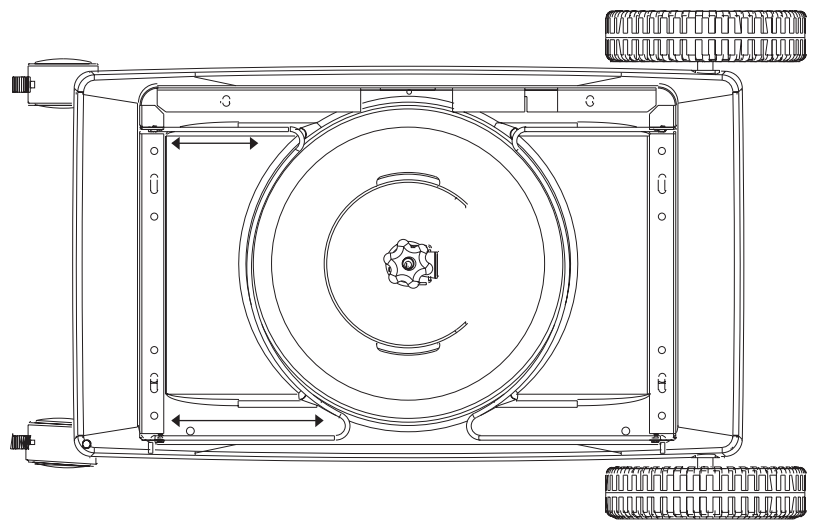
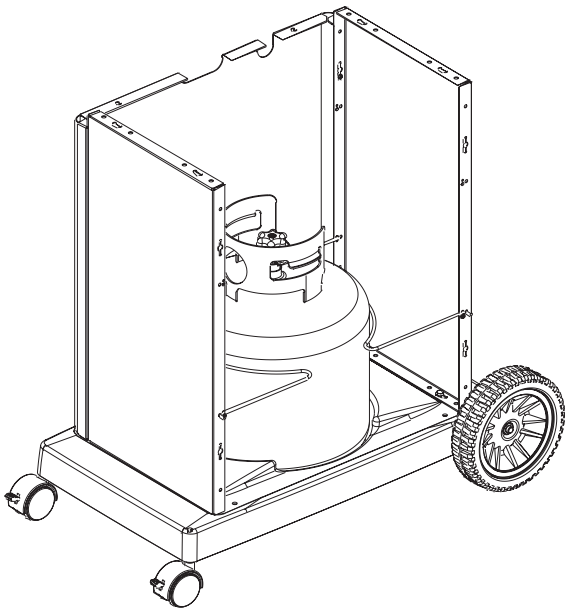
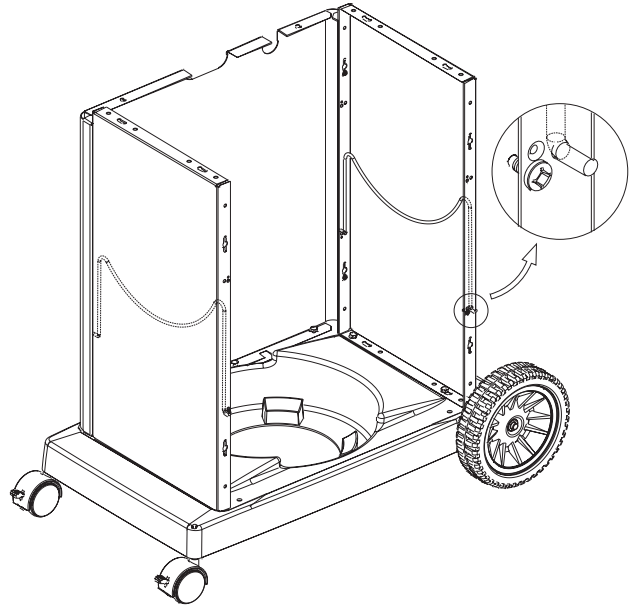
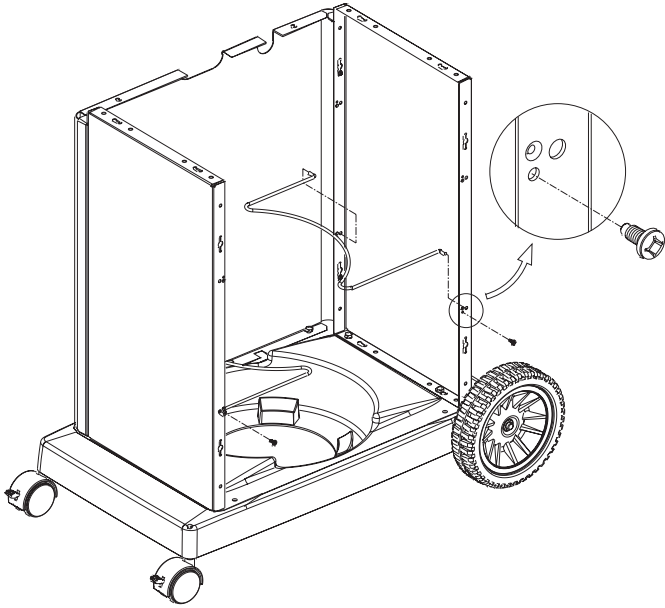

7

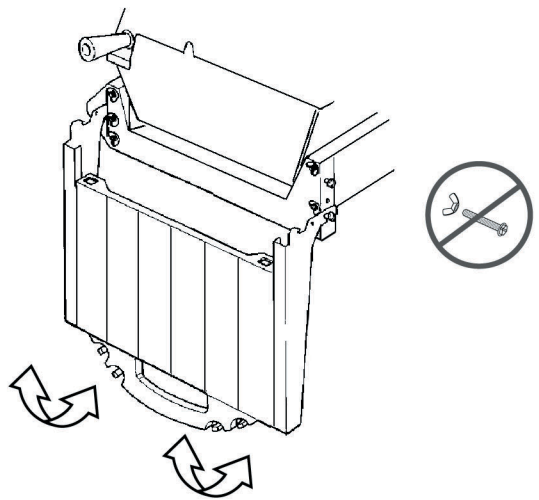
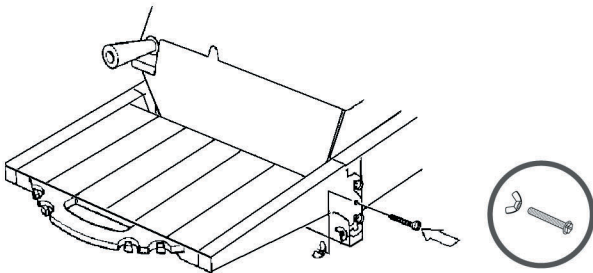
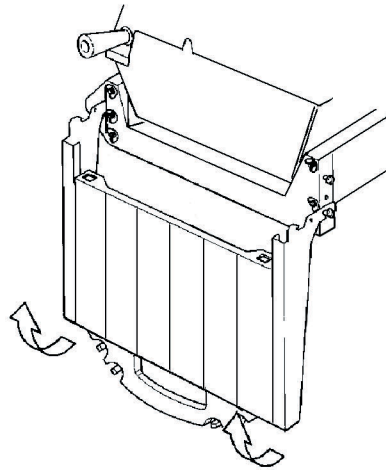
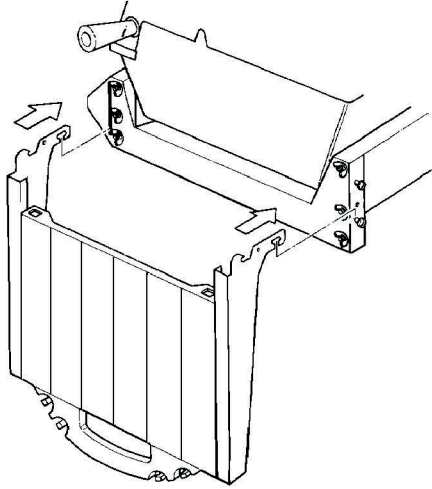
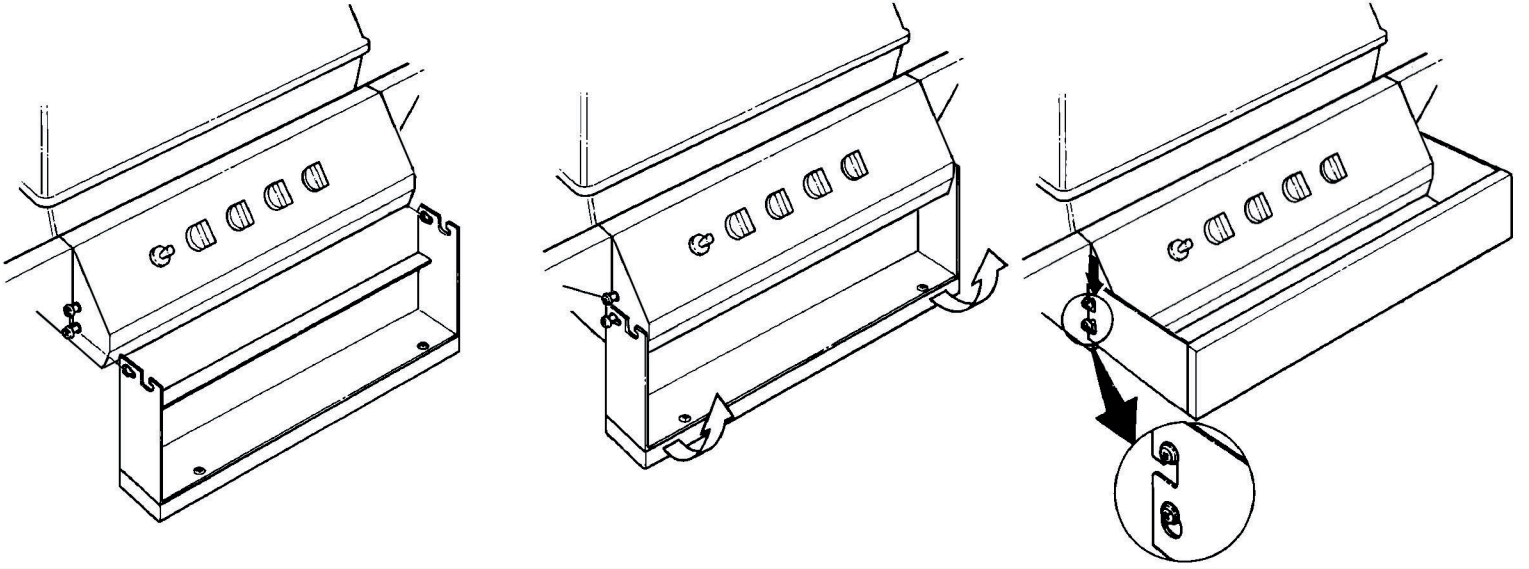
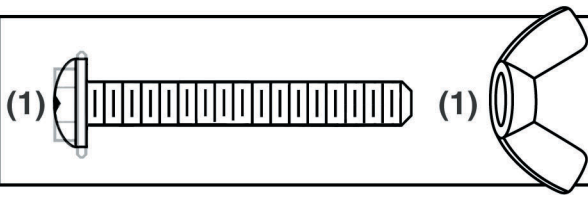

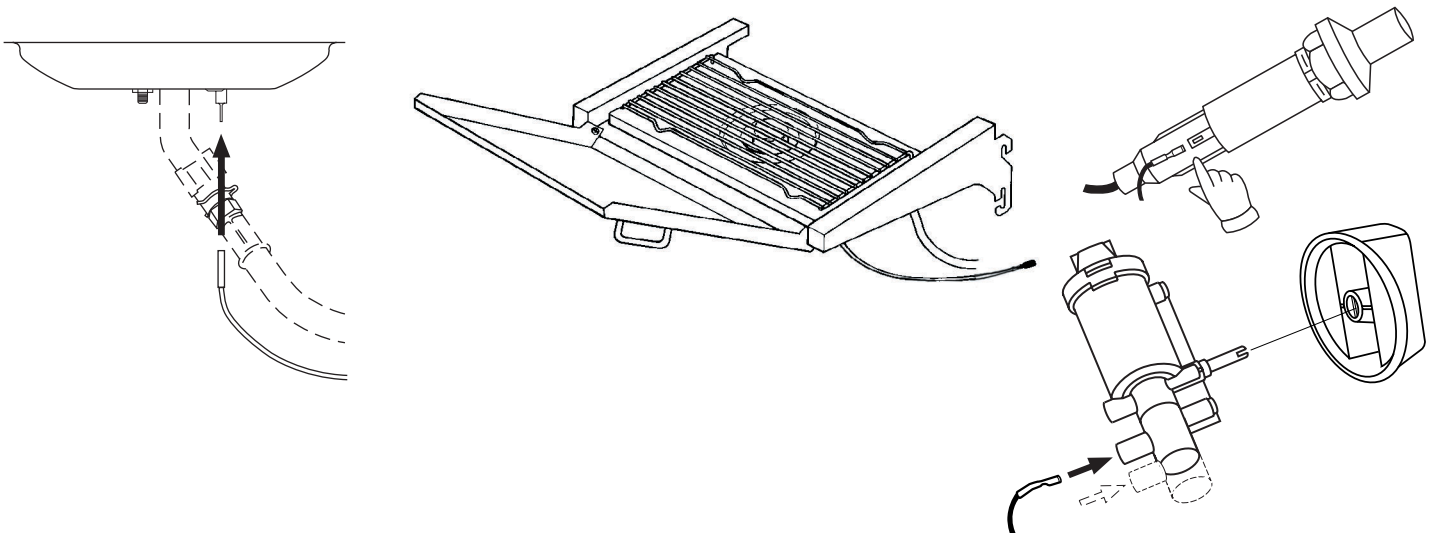
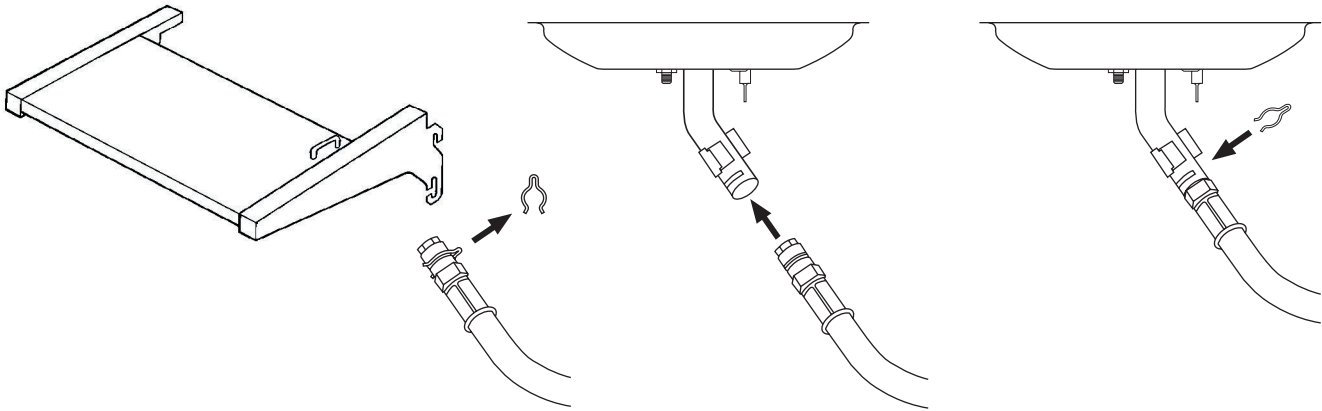
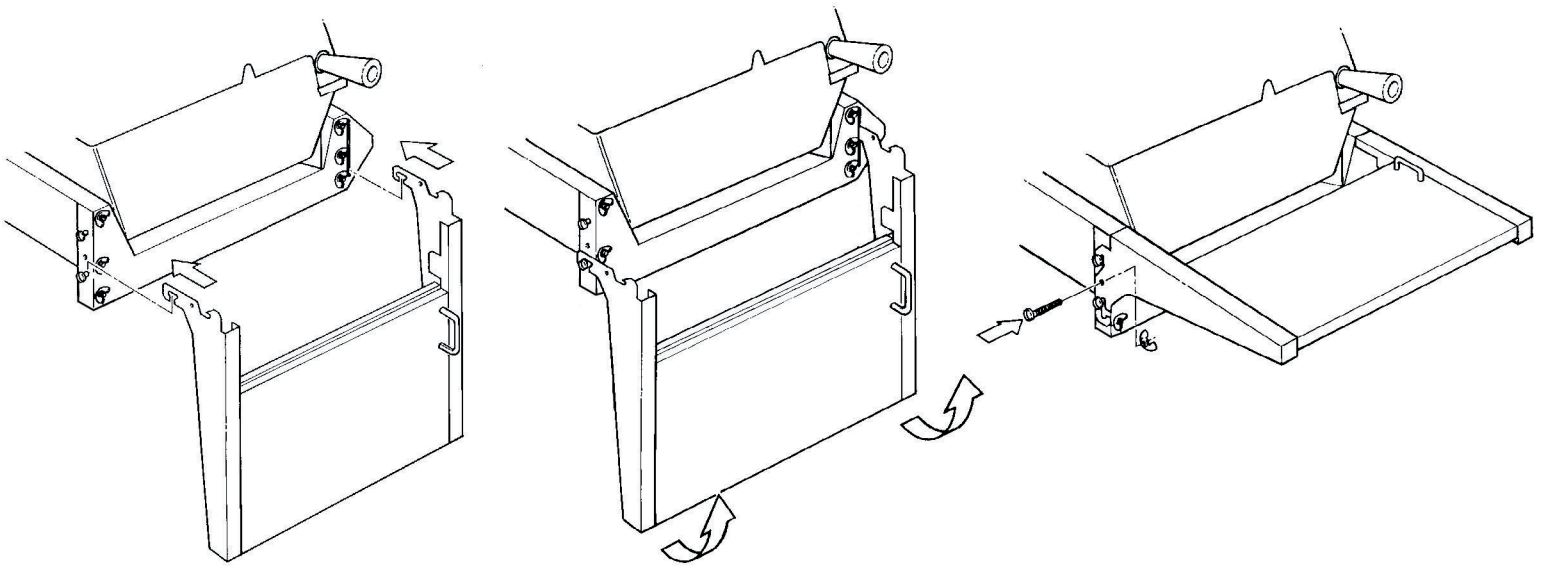
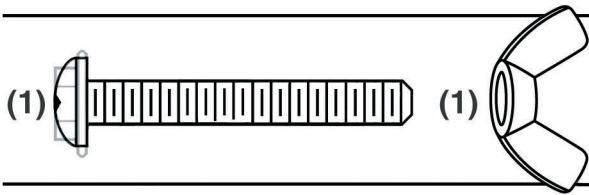

8

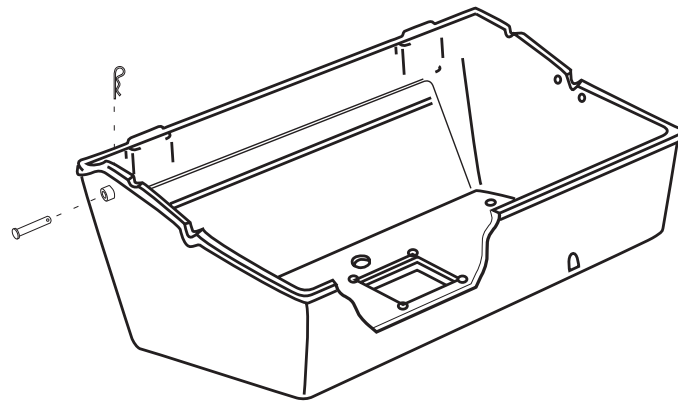
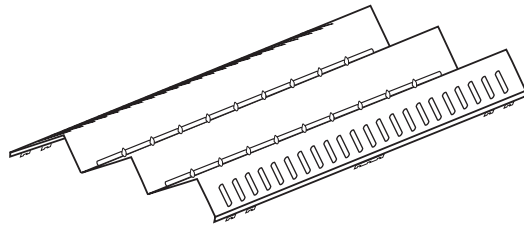
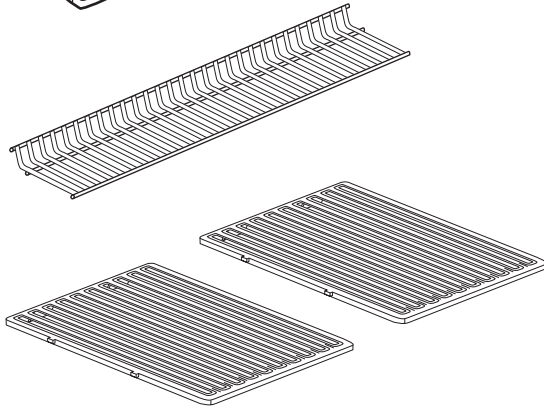
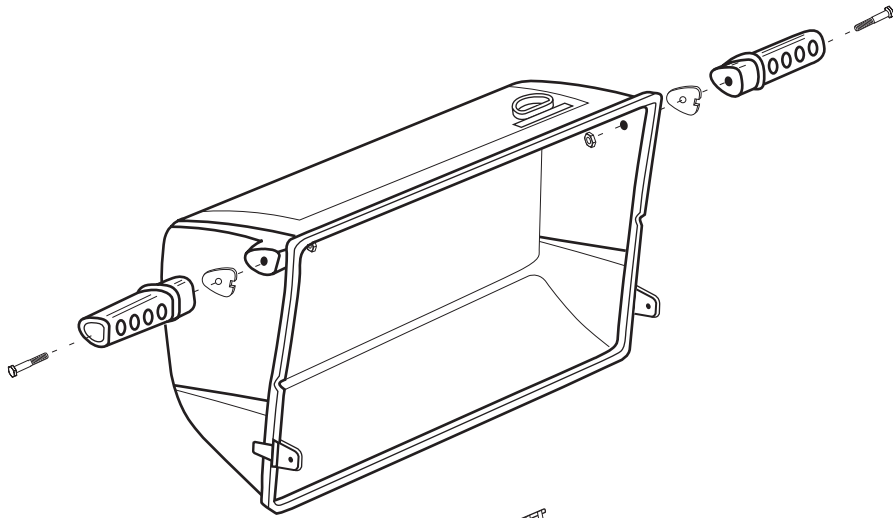
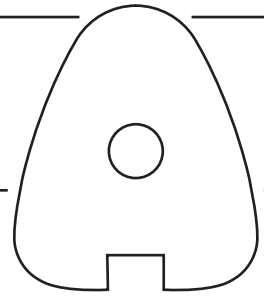
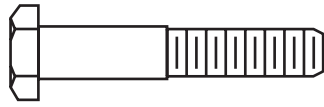
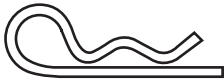
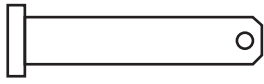

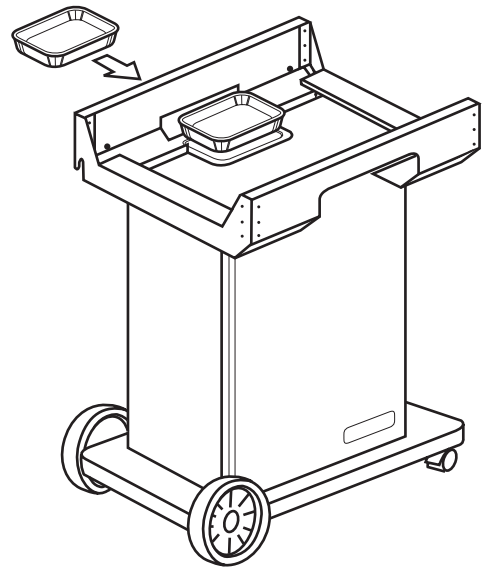
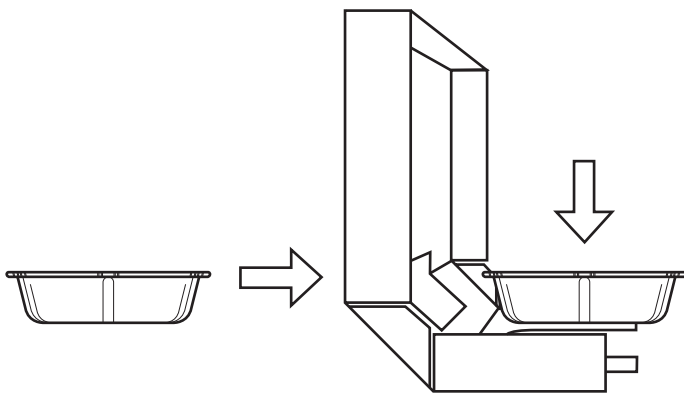
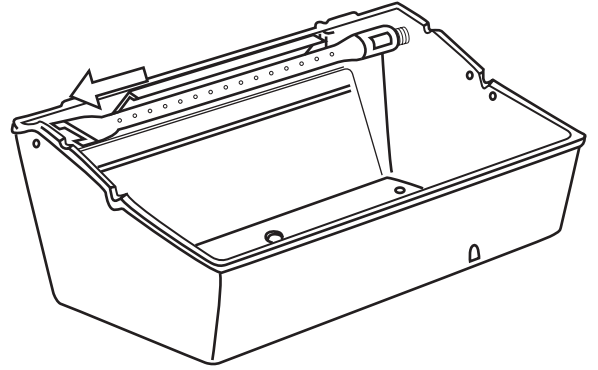
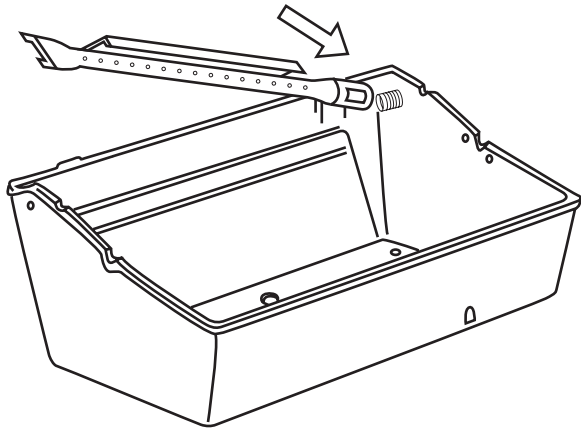

PARTS LIST / LISTE DES PIECES

KEY #	ITEM #	DESCRIPTION	DESCRIPTION	956-24	956-44	956-74	956-94	956-94S
				<u>956-27</u>	<u>956-47</u>	<u>956-77</u>	<u>956-97</u>	<u>956-97S</u>
1	10909-T45	CASTING BOTTOM	FOND DU FOYER	1	1	1	1	1
2	10473-T45	CASTING TOP	COUVERCLE DU GRIL	1	1	1	1	1
3	10081-BK603	NAMEPLATE	PLAQUE D'IDENTIFICATION	1	1	1	1	1
3A.	10081-BK601	NAME PLATE	PLAQUE D'IDENTIFICATION	1	1	1	1	1
4	10958-K70	LID INSERT	PANNEAU DE COUVERCLE	1	1	1	1	1
5	10571-6	HEAT INDICATOR	INDICATEUR DE CHALEUR	1	1	1	1	1
6	10240-15	HINGE PIN	CHEVILLE DE CHARNIERE	2	2	2	2	2
7	S21233	HINGE CLIP	ATTACHE DE CHEVILLE	2	2	2	2	2
8	10222-T425	FLAV-R-WAVE – S.S.	FLAV-R-WAVE – A.I.	1	1	1	1	1
9	10225-T429	GRID – CAST IRON	GRILLE DE FONTE	2	2	2	2	2
11	10225-T451	FLAT WARMING RACK	GRILLE DE RÉCHAUD	1	1	1	1	1
15	10390-T501	BURNER ASSY	ENSEMBLE DE BRULEUR	1	1	1	1	1
17	10342-242	IGNITOR	ALLUMEUR	1	•	1	•	•
	10342-243	IGNITOR	ALLUMEUR	•	1	•	1	1
	10472-K40	ROTARY IGNITOR KNOB	BOUTON ROTATOIRE D'IGNITOR	1	1	1	1	1
18	10342-T301	ELECTRODE	ELECTRODE	2	2	2	2	2
21	10440-K50	CONTROL ASSY LP	SOUPAPE, (GAZ PROPANE)	1	•	•	•	•
	10440-K51	CONTROL ASSY NG	SOUPAPE, (GAZ NATUREL)	1	•	•	•	•
	10442-K52	CONTROL ASSY LP	SOUPAPE, (GAZ PROPANE)	•	1	•	•	•
	10442-K53	CONTROL ASSY NG	SOUPAPE, (GAZ NATUREL)	•	1	•	•	•
	10440-R62	CONTROL ASSY LP	SOUPAPE, (GAZ PROPANE)	•	•	1	•	•
	10440-R63	CONTROL ASSY NG	SOUPAPE, (GAZ NATUREL)	•	•	1	•	•
	10442-R56	CONTROL ASSY LP	SOUPAPE, (GAZ PROPANE)	•	•	•	1	1
	10442-R57	CONTROL ASSY NG	SOUPAPE, (GAZ NATUREL)	•	•	•	1	1
21A.	S13467-091	HOSE – SIDE BURNER LP	TUYAU DU BRULEUR LATERAL PL	•	1	•	1	1
	S13467-132	HOSE – SIDE BURNER NG	TUYAU DE BRULEUR LATERAL GN	•	1	•	1	1
	Y-11230	COTTER PIN	ATTACHE DE CHEVILLE	•	1	•	1	1
21B.	10110-91	HOSE – REARBURNER	TUYAU DE BRULEUR ARRIERE	•	•	1	1	1
22	10114-20	HOSE & REGULATOR LP – QCC1	TUYAU ET REGULATEUR PL – QCC1	1	1	1	1	1
	10111-K47	HOSE NATURAL GAS	TUYAU GN	1	1	1	1	1
23	10472-K37	CONTROL KNOB	BOUTON DE CONTROLE	2	3	3	4	4
30	10086-R51S	DECO PLATE – S.S.	PLAQUE DECORATIVE – A.I.	1	•	•	•	•
	10086-R52S	DECO PLATE – S.S.	PLAQUE DECORATIVE – A.I.	•	1	•	•	•
	10086-R54S	DECO PLATE – S.S.	PLAQUE DECORATIVE – A.I.	•	•	1	•	•
	10086-R53S	DECO PLATE – S.S.	PLAQUE DECORATIVE – A.I.	•	•	•	1	1
31	10194-R561	CONTROL COVER	PANNEAU DE CONTROLE	1	1	1	1	1
33	10184-R801	RADIATION SHIELD	ÉCRAN DE CHALEUR	1	1	1	1	1
35	10184-R561	SUPPORT – CASTING – LEFT	SUPPORT GAUCHE DU FOYER	1	1	1	1	1
36	10184-R571	SUPPORT – CASTING – RIGHT	SUPPORT DROIT DU FOYER	1	1	1	1	1
37	10184-K581	SUPPORT – SIDE SHELF – LH	SUPPORT TABLETTE DE GAUCHE	2	2	2	2	2
38	10184-K591	SUPPORT – SIDE SHELF – RH	SUPPORT TABLETTE DE DROITE	2	2	2	2	2
39	10956-R831	BRACE – UPPER REAR	SUPPORT ARRIERE	1	1	1	1	1
40	10958-R81	SHELF – LOWER	TABLETTE INFERIEURE	1	1	1	1	1
41	10958-K851	PEDESTAL – FRONT BRACE	SUPPORT AVANT	1	1	1	1	1
42	10958-K881	PEDESTAL – FRONT PANEL	POTEAU-SUPPORT AVANT	1	1	1	1	•
	10958-K89	PEDESTAL – S.S. FRONT PANEL	POTEAU-SUPPORT AVANT	•	•	•	•	1
43	10958-R861	PEDESTAL – SIDE PANEL	POTEAU-PANNEAU LATERALE	2	2	2	2	2
47	10184-R19	TANK RETAINER	SERVITEUR DU RESERVOIR PL	2	2	2	2	2
49	10711-K541	CONDI-BIN	CONDI-BIN	1	1	1	1	1
50	10711-K551	SHELF – SIDE	PLANCHETTE LATERALE	1	1	1	1	•
	10711-K70	SHELF – SIDE S.S.	PLANCHETTE LATERALE	•	•	•	•	1
51	10711-K551	SHELF – SIDE	PLANCHETTE LATERALE	1	•	1	•	•
53	S16144	SHELF BOARD – FRONT	PLANCHETTE AVANT	1	1	1	1	1
56	10892-8	WHEEL	ROUE	2	2	2	2	1
65	S13009	BURNER ROTISSERIE	BRULEUR A ROTISS	•	•	1	1	1
68	S21362	SPRING	RESSORT	•	•	1	1	1
70	Y-11990	HEX NUT	ECROU	•	•	1	1	1

PARTS LIST / LISTE DES PIECES

<u>KEY #</u>	<u>ITEM #</u>	<u>DESCRIPTION</u>	<u>DESCRIPTION</u>	<u>956-24</u>	<u>956-44</u>	<u>956-74</u>	<u>956-94</u>	<u>956-94S</u>
				<u>956-27</u>	<u>956-47</u>	<u>956-77</u>	<u>956-97</u>	<u>956-74S</u>
71	10696-109 LP	REARBURNER-ORIFICE LP	ORIFICE DU BRULEUR ARRIERE PG	•	•	1	1	1
	10696-160 NG	REARBURNER-ORIFICE NG	ORIFICE DU BRULEUR ARRIERE GN	•	•	1	1	1
73	S21420	PUSH NUTS	POUSSE ECROU	2	2	2	2	2
74	Y-6616	BOLT – 1/4:20 x 1 1/2	BOULON – 1/4:20 x 1 1/2	2	2	2	2	2
75	10338-145	HANDLE	POIGNEE	2	2	2	2	2
76	10239-6	WASHER - HANDLE	RONDELLE DE LA POIGNEE	2	2	2	2	2
78	10892-15	CASTOR	ROULETTES	2	2	2	2	2
79	Y-11561	BOLT – 1/4:20 x 1 3/4	BOULON - 1/4:20 X 1 3/4	2	2	2	2	2
80	Y-11546	BOLT - 1/4:20 X 5/8	BOULON - 1/4:20 X 5/8	8	8	8	8	8
81	Y-11545	SCREW – 1/4-20 X 1 3/8	VIS – 1/4-20 X 1 3/8	4	4	4	4	4
82	Y-12860	SCREW - 1/4:20 X 1	VIS - 1/4:20 X 1	2	2	2	2	2
82A.	Y-12855	SCREW – 1/4:20 X 3/8	VIS - 1/4:20 X 3/8	14	14	14	14	14
83	S21014	BOLT 1/4:20 X 3/4	BOULON 1/4:20 X 3/4	6	6	6	6	6
84	S15171	AXLE	ESSIEU	1	1	1	1	1
86	Y-11795	NUT – LOCKING – 1/4-20	ECROU – SERRURE – 1/4-20	8	8	8	8	8
87	Y-11793	NUT - 1/4"	ECROU - 1/4"	22	22	22	22	22
88	Y-11598	NUT WING - 1/4"	ECROU PAPILLON – 1/4"	2	2	2	2	2
96	S21123	SCREW - 8 X 1/2"	VIS - 8 X 1/2"	4	4	4	4	4
97	Y-12643	SCREW – 8 X 1/2	VIS - 8 X 1/2	4	4	4	4	4
98	S21124	SCREW - 8 X 1/2"	VIS - 8 X 1/2"	28	28	28	28	28
99	Y-12646	SCREW - SHOULDER	VIS	4	6	4	6	6
101	Y-12853	WASHER - #8	RONDELLE - #8	4	4	4	4	4
104	Y-12835	SCREW 6:32 X 1/4	VIS 6:32 X 1/4	•	2	•	2	2
105	Y-29307	NUT - 10:24	ECROU - 10:24	•	4	•	4	4
108	PB20-60	LID HANDLE	POIGNEE	•	1	•	1	1
109	S21136	SCREW 8 – 32 X 3/8	VIS 8- 32 X 3/8	4	6	4	6	6
110	10225-T10	GRID	GRILLE	•	1	•	1	1
111	10390-E10	SIDE BURNER	BRULEUR DE COTE	•	1	•	1	1
113	10342-T14	ELECTRODE & WIRE - SIDE BURNER	ELECTRODE & FER - BRULEUR DE COTE	•	1	•	1	1
114	10393-K40	COVER - SIDE BURNER	COUVERCLE LATÉRAL	•	1	•	1	1
115	Y-29305	SCREW 10:24 X 3/8	VIS 10:24 X 3/8	2	8	4	8	8
117	10393-R50	SHELF - SIDE BURNER	SUPPORT DE BRULEUR DE COTE	•	1	•	1	1
123	S15115	GREASE PAN - DISPOSABLE	CUVETTE A GRAISSE	1	1	1	1	1

